

User Manual

K-BUS® Fan Coil Actuator with 0-10V_V1.3

AFVFT-07/10.1

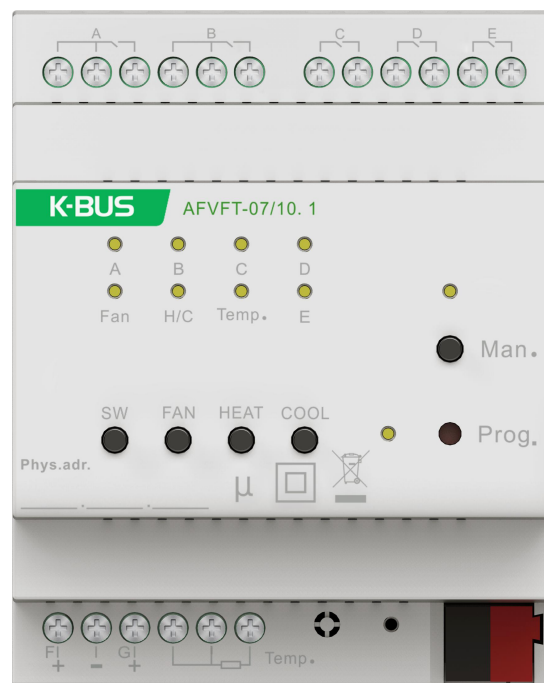

KNX/EIB Intelligent Installation Systems

Attentions

1. Please keep devices away from strong magnetic field, high temperature, wet environment;

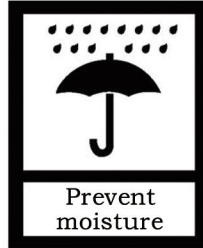
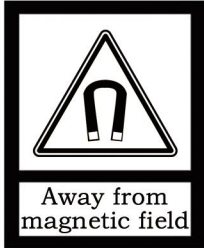

2. Please do not fall the device to the ground or make them get hard impact;



3. Please do not use wet cloth or volatile reagent to wipe the device;



4. Please do not disassemble the devices.

Contents

Chapter 1 General -----	4
Chapter 2 Technical Data -----	5
Chapter 3 Functional, Dimension and Connection Diagram -----	7
3.1 Dimension diagram -----	7
3.2 Connection diagram -----	7
Chapter 4 Parameter setting description in ETS -----	9
4.1 Parameter window “General” -----	9
4.2 Parameter window “Interface Setting” -----	10
4.3 Switch output -----	12
4.3.1 Parameter window “Output X”-----	12
4.3.2 Parameter window “X: Time”-----	16
4.3.2.1 Selection “Delay”-----	17
4.3.2.2 Selection “Flashing”-----	17
4.3.2.3 Selection “Staircase”-----	18
4.3.3 Parameter window “X: Logic”-----	20
4.3.4 Parameter window “X: Scene”-----	22
4.3.5 Parameter window “X: Forced”-----	23
4.3.6 Parameter window “X: Operation hours counter”-----	24
4.4 Fan coil controller -----	25
4.4.1 Parameter window “HVAC General”-----	25
4.4.1.1 Local-----	26
4.4.1.2 Bus-----	28
4.4.2 Parameter window “Temperature”-----	29
4.4.3 Parameter window “Setpoint”-----	31
4.4.3.1 Temperature setting adjustment instruction-----	34
4.5 Fan control -----	35
4.5.1 Parameter window “Fan type -- One level”-----	35
4.5.1.1 Parameter window “Auto. operation”-----	39
4.5.1.2 Parameter window “Fan status”-----	43
4.5.2 Parameter window “Fan type -- Multi-level”-----	44
4.5.2.1 Parameter window “Fan: Auto. operation”-----	51
4.5.2.2 Parameter window “Fan: status”-----	57
4.6 Valve Output -----	59
4.6.1 Parameter window “Heating/Cooling valve (Relay)”-----	60
4.6.2 Parameter window “Heating/Cooling valve (0-10V)”-----	64
4.6.3 Parameter window “Scene”-----	66
4.6.4 Fan automatic control and coil-----	68
Chapter 5 Description of Communication Objects -----	69
5.1 Communication objects of Switch outputs -----	69
5.2 Communication object of Fan coil control -----	72
5.3 Communication object of Fan control -----	74
5.4 Communication Object of Coil Output -----	78

Chapter 1 General

The Fan Coil Actuator with 0-10V is mainly used for the fan and valve control, can be installed in central air conditioning control system. The motor supports 230V AC drive and 24V AC with 0-10V drive interface. The device can be also used to control the lamp. Moreover, it supports manual operation which is on the front of the device to facilitate engineering commission.

The Fan Coil Actuator with 0-10V is a modular installation device for fast installation in the distribution board on 35 mm mounting rails to DIN EN 60 715. The electrical connection is implemented by using screw terminals. The connection to the KNX/EIB bus is implemented using the supplied bus connection terminal, and no need an extra voltage supply.

This manual provides detailed technical information about the Fan Coil Actuator with 0-10V for users as well as assembly and programming details, and explains how to use the Fan Coil Actuator with 0-10V by the application examples.

The functions of the Fan Coil Actuator with 0-10V is summarized as follows:

—Fan control:

- Support the fan with 1-2-3 level fan speed
- Forced operation: the fan speed is only allowed to run in set fan speed range, and the force operation has the highest priority.
- Auto. Operation: the desired speed is run automatically according the control value that is received from the sensor device, and the auto. Operation can be set four limits and the minimum dwell period of fan speed
- Direct operation: control the fan speeds via a manual operation, as via operating a panel
- The fan with multi-level speeds can set its starting characteristic
- The fan with single-level speed can set on/off delay or on/off minimum time
- Status response, as the current operation, fan on/off status, speed status
- Power recovery function, the fan speed can be defined after reset

—Coil control

- Ordinary on/off valve control and PWM continuous valve control supporting two/four tube control
- Built-in PI algorithm to support local / bus control valves
- Disable/enable heating or refrigerating valves
- Valve switch status feedback
- Manual or automatic cleaning of the valve to send cleaning status
- Provides 8 scene functions for joint control of fan and coil status, call or store via 1byte object
- Local control supports standby, comfort, night and protection modes of operation and status feedback
- With temperature acquisition function, input external three-wire PT1000 temperature sensor can collect local actual temperature.

— **Switch output**

- Set the relay contact position after bus voltage recovery or bus failure
- Time function: on/off delay, flashing switch, staircase lighting control
- Provide 8 scenes, recall and storing via a 1byte object
- Logic operation: AND, OR, XOR, gate function
- Forced operation: 1bit/2bit
- Operation hours counter
- Central control function

— **Load drive interface**

- The relays can be used as switch output when it is not used to control the fan speed or valve.
- 2 channels of 0-10V output can be used for fan or valve control

The assignment of the physical address and the setting of the parameters can be done using the engineering tool software ETS (version ETS4 or higher) with the knxprod file.

In order to ensure that all functions of this product are used correctly, it is necessary to check whether there is any problem with the wiring before use. At the same time, attention should be paid to the technical characteristics of the load device when setting the parameters, especially the fan coil. Some technical characteristics are inherent to the device. If the settings are not appropriate, it may cause damage to the load device or may not operate properly.

Chapter 2 Technical Data

Power Supply	Bus Voltage, EIB	21~30V DC, from EIB bus
	Quiescent Current, EIB	<15mA
	Dynamic current, EIB	<24mA
	Power consumption, EIB	<450mW
	Power consumption, Output 10A	<1W
Connection	EIB/KNX	Via bus connection terminals (red/black) , Ø0.8 mm
	Output, 10A	Screw terminals Wire Range 0.5-2.5mm ² Torque 0.4N-m
Operation/ display	Programming button and Red LED	Programming physical address
	Green LED flashing	The application layer works normally
Housing	IP 20, EN 60 529	
Temperature range	Operation	-5°C.....+45°C
	Storage	-25°C.....+55°C
	Transport	-25°C.....+70°C
Ambient conditions	Max. air humidity	<93%, except dewing
Design	Modular installation device (MDRC)	

Housing/color	Plastic housing, gray	
Installation	On 35mm DIN-Rail	To EN 60 715
Dimension	72mm ×90 mm ×64mm	
Weight	0.3KG	
0-10V Output	2 channels	
	Output Voltage	0~10V, with isolation
	Signal type	Analog output
	Max. Output Current	1.5mA (per channel)
Output, 10A	5 channels	Can be individually set
	U _n rated voltage	230V AC (50/60Hz)
	I _n rated current capacity	10A/105uF
	Max. switching current	16A/240V AC
	Mechanical life	>2×10 ⁶
	Electrical life	>5×10 ⁴
	Max. DC current switching capacity (resistive load)	16A/30V DC
Temp. Measurement	Three-wire system PT1000 Temp. sensor	Used to detect room temperature
	Measuring scope of Temp.	- 45°C ... + 80°C, ±1°C
	Cable length	2m

Note:

The above load is only for single lamp. In the case of several lamps in parallel, the power of load will be reduced, although the power is unchanged, but the instantaneous impact of current will increase, and easy to make the relay contacts melted. So, in normal use, subject to the measured current, the measured maximum inrush current must be within the allowable range.

Application program:

Model	Max. number of communication objects	Max. number of group addresses	Max. number of associations
AFVFT-07/10.1	91	160	160

Chapter 3 Functional, Dimension and Connection Diagram

3.1 Dimension diagram

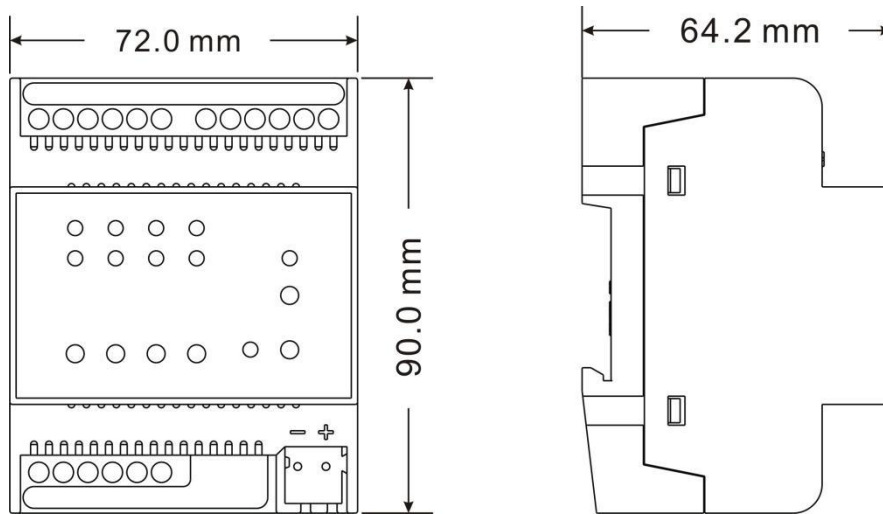

3.2 Connection diagram

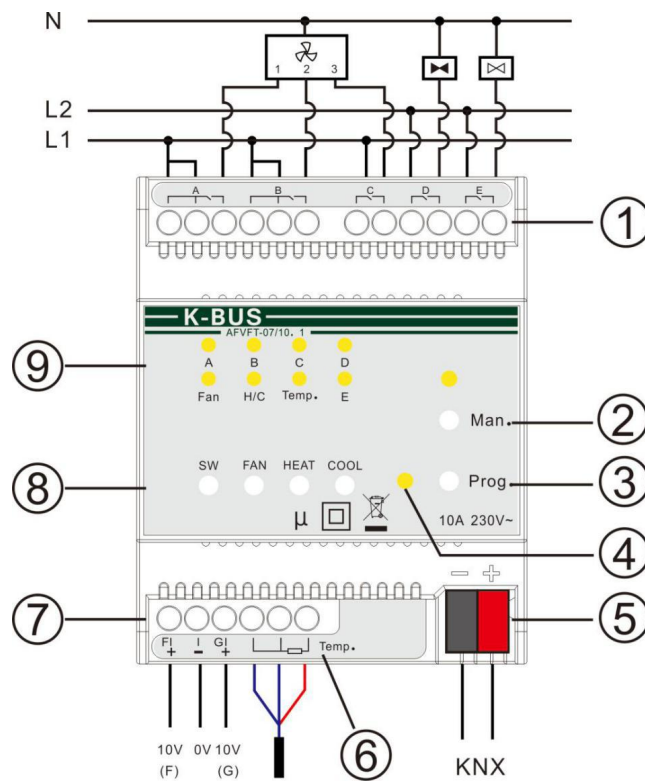

①5 fold relay outputs: via the parameters can be set as fan speeds(A/B/C), valves (D for Heating,E for Cooling) or general switch outputs

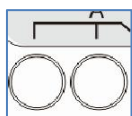

Note: the silk screen mark the two terminals are internally connected .

②Man./Auto. operation switch button: switch to Man. operation via long press 1s, and the LED is on in the front of button.

③Programming button, to assign physical address.

④Programming LED: Red LED for assigning the physical address,Green LED for displaying application layer running normally.

⑤EIB/KNX bus connection terminal.

⑥Three-wires PT1000 temperature sensor.

⑦Two channel 0-10V outputs: via the parameters can be set as the fan or valve outputs.

⑧Operate buttons. From left to right: Switch control, Fan speed, Heating, Cooling.

Illustrate:

1) SW: Switch output button, via long operation to select the output channels, via short operation switch on/off the current selected channel. The output LED flashing display the selected channel, fast flashing is that relay contact is open, slow flashing is that the relay contact is closed.

2) FAN: Via long operation to switch off the fan, via short operation to switchover the fan speeds.

3) HEAT: Switch on/off fully the heat valve.

4) COOL: Switch on/off fully the cool valve.

⑨LED display: A,B,C,D,E display switch output status;

Fan red -- the fan speed 1, Fan green --the fan speed 2, Fan blue-- the fan speed 3;

H/C red -- heating, H/C blue -- cooling;

Temp. On -- local temperature error.

Chapter 4 Parameter setting description in ETS

The description of the parameter settings in the ETS system is described in the form of function blocks.

4.1 Parameter window “General”

Parameter window “General” can be shown in fig. 4.1, this is mainly set some basic parameters for the Fan Coil Actuator.

General	Relay operation delay after power voltage recovery[5...250s]	10
Interface Setting	Sending cycle of "In operation" telegram (1...240s,0=inactive)	0
HVAC-General	Manual operation	<input type="radio"/> Disable <input checked="" type="radio"/> Enable
Temperature	Manual to automatic by	<input checked="" type="radio"/> Only long press <input type="radio"/> Both long press and automatic Delay time
Setpoint	Report operation status function for HVAC	<input checked="" type="radio"/> Disable <input type="radio"/> Enable
Heating valve (Relay)	Central control for switch function	<input checked="" type="radio"/> Disable <input type="radio"/> Enable

Figure 4.1 Parameter Setting Interface “General”

Parameter “Relay operation delay after power voltage recovery[5...250s]”

This parameter defines the delay time of the relay operation after the device power voltage recovery.

The actions are only executed or the telegrams are only sent when the delay is completed.

This delay time does not include the initialization time of the device. After the power supply voltage is restored, the initialization time of the device startup is about 3 s. It means the delay time starts after the device initialization.

Note: During delay, the programming green LED is on, after the delay is completed, the green LED flashes, and the relay can be operated.

Parameter “Send cycle of “In operation” telegram (1...240s, 0 = inactive)”

This parameter sets the interval time this module cyclically sends telegram through the bus to indicate the normal operation of this module.

When it is set as “0”, the object “in operation” will not send a telegram.

If the setting is not “0”, the object “in operation” will send a telegram with logic “1” to the bus according to the set time period.

Options: 0.....240s,0=cyclic transmission prohibited

In order to reduce the bus load as much as possible, the maximum time interval should be selected according to actual needs.

Note: The time period starts from bus voltage recovery, regardless of the operation delay.

Parameter “Manual operation”

The parameter defines whether the manual operation enables. Options:

Disable

Enable

If the enable is selected, the Man. /Auto Button has been enabled. And the follow parameter is visible.

Parameter "Manual to automatic by"

Options:

Only long press

Both long press and automatic delay time

If set "only long press", the manual/auto. Operation only can be switched via long press the Man. Button.

If set "both long press and automatic delay time", the manual/auto. Operation can be switched via long press the Man. Button. or the set time for the manual to automatic has elapsed.

Parameter "Delay time *1s [10.. 6000]"

The parameter appears when "Both long press and automatic delay time" is selected in the parameter "Manual to automatic by" . It is used for setting the time for an automatic reset from the "manual operation" to "automatic operation" state after the last push button operation.

Options: 10.....6000s

Parameter "Report operation status function for HVAC"

This parameter is to set the Report operation status function for HVAC. Options:

Disable

Enable

While "Enable", the object "Status of operation" is visible. Define object as follows,

DPT_StatusHVAC: B6N2							
7	6	5	4	3	2	1	0
0: Auto. Operation	0: Limit 4 disable	0: Limit 3 disable	0: Limit 2 disable	0: Limit 1 disable	0: Cooling	00: comfort mode	
1: Man. Operation	1: Limit 4 enable	1: Limit 3 enable	1: Limit 2 enable	1: Limit 1 enable	1: Heating	01: standby mode	
						10: night mode	
						11: Frost/heat protection mode	

Parameter "Central control for switch function"

This parameter sets the central control for switch function. Options:

Disable

Enable

If enable, the object "Central control for all of switch" is visible, all channels with central control enabled can be switched together via the object.

4.2 Parameter window "Interface Setting"

Parameter window "Interface Setting" can be shown in fig. 4.2, here mainly set the fan drive interface and

valve drive interface for the Fan Coil Actuator. The fan or valve drive can be selected to the relay output or 0-10V output. The relays can be used as switch output when it is not used as the fan or valve drive interface. When the outputs A~E as switch outputs, parameters and objects which are assigned to each output are the same. The follow chapters are described in the form of function blocks.

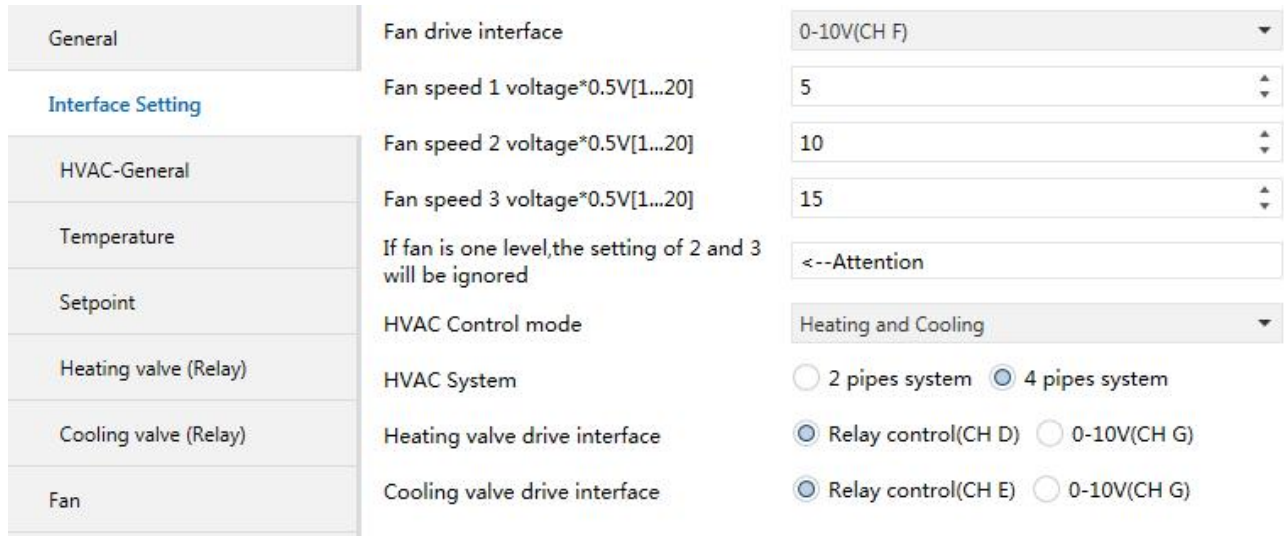

Figure 4.2 Parameter Setting Interface "Interface Setting"

Parameter "Fan drive interface"

This parameter is used to select the drive type of the fan speed. Available options:

Disable

Relay control (CH A-C)

0-10V (CH F)

Disable: the fan drive is not enabled

Relay control (CH A-C): the fan drive selects the relay output CH A-C, CH A: Fan speed 1; CH B: Fan speed 2; CH C: Fan speed 3.

0-10V (CH F): the fan drive selects the 0-10V output CH F

Parameter "Fan speed 1/2/3 voltage*0.5V[1..20]"

When the drive type of the fan speed of the fan is 0-10V, this parameter is visible. It is used to set the voltage value that drives the output of each fan speed. Options: 1..20

Parameter "If fan is one level, the setting of 2 and 3 will be ignored"

This parameter indicates that the setting of fan speed 2 and 3 will be ignored if the fan is only one level. Similarly, if the fan is two levels, the setting of fan speed 3 is ignored.

Parameter "HVAC Control mode"

This parameter sets the HVAC control mode. Options are:

Disable

Heating

Cooling

Heating and Cooling

Heating: The fan coil can only achieve heating function;

Cooling: The fan coil can only achieve the cooling function;

Heating and cooling: it can achieve heating or cooling, the fan coil controller will automatically outputs whether it is heating or cooling according to d-value between the set temperature and the actual temperature and Insensitive zone temperature. In the meantime, the following parameters are visible.

Parameter “HVAC System”

This parameter is used to set the HVAC system, that is, define the pipe system of Fan coil.

2 pipes system

4 pipes system

2 pipes system: heating and cooling shared one inlet and outlet pipe. (heating and cooling are controlled via one valve).

4 pipes system: heating and cooling use their own inlet and outlet pipes, they have their valve to control the in and out of hot and cold water.

Parameter “Heating/Cooling valve drive interface”

This parameter is used to select the type of drive for the heating/cooling valve. Options:

Relay control (CH D/CH E)

0-10V (CH F/CH G)

Relay control: the valve drives are selected the relay output.

0-10V: the valve drives are selected 0-10V output.

The following three sections describe the switch output, fan and coil control functions:

4.3 Switch output

There are 5 outputs. As parameters and objects which are assigned to each output are the same. Using output A as an example described.

4.3.1 Parameter window “Output X”

Parameter window “Output X” can be shown in fig.4.3. which applies to a whole output. In addition to setting general switching function, but also set position of switch on the bus power on and power down , reports of switch status, etc..

General	Switch function	<input type="radio"/> Disable <input checked="" type="radio"/> Enable
Interface Setting	Central function of channel	<input type="radio"/> Disable <input checked="" type="radio"/> Enable
Output A	When bus recovery,contact is	Unchange
Output B	When bus failure,contact is	Unchange
Output C	After downloading,contact is	<input checked="" type="radio"/> Open <input type="radio"/> As bus recovery
Output D	Object value of "switch" after bus recovery or downloading	<input checked="" type="radio"/> 0 <input type="radio"/> 1
Output E	Reply mode of switch status	Respond after change
Version	Object value of switch status	<input type="radio"/> 0=contact close;1=contact open <input checked="" type="radio"/> 1=contact close;0=contact open
	Contact position if tele.value is "1" ("0" is opposite of "1" if changed)	<input type="radio"/> Open <input checked="" type="radio"/> Close
	Special function of channel	<input checked="" type="radio"/> Disable <input type="radio"/> Enable

Fig. 4.3 parameter window "Output X"

Parameter "Switch function"

To set whether to enable the switch output channel X (X=A..E).

If enable, the follow parameters will be visible.

Parameter "Central control of channel"

The parameter sets whether the central control of the channel is enabled. Options:

Disable

Enable

If enable, the channel can be controlled via the object "Central switch" .

Parameter "When bus recovery, contact is"

The output can adopt a defined status on bus voltage recovery via this parameter. Options:

Unchange

Open

Close

As before as bus fail

When selecting "Unchanged", the contact of the relay will remain the same as the last status on the power on.

When selecting "open", the contact will be open; while it is closed when selecting "closed".

The contact position after voltage recovery is the same as that before power off with "As before bus voltage fail".

Parameter "When bus failure, contact is"

The output can adopt a defined status after the bus voltage failure via this parameter. Options:

Unchange

Open

Close

When selecting “Unchange”, the contact of the relay will remain the same as the last status before power off; when selecting “open”, the contact will be open; while it is closed when selecting “closed”.

Parameter “After downloading, contact is”

This parameter set the contact position of the output after downloading. Options:

Open

As bus recovery

If “open”, the output is open after downloading.

If “As bus recovery”, the output adopts the defined status of the parameter “If bus recovery, contact is”

Parameter “Object Value of “Switch” after bus recovery or downloading”

This parameter will be used when enabling the logic function “input 0” to define the default value of the communication object “Switch” after bus voltage recovery, which can be “0” or “1”. Options:

0

1

Parameter “Reply mode of switch status”

This parameter defines how to respond the current switch status to the bus. There are three options to select.

Options:

Respond after read only

Respond after change

Respond always

If selecting “respond after read only”, the status telegram will not be sent out until receiving a read request telegrams via the object “reply switch status” from the bus.

If selecting “respond after change”, it will send the status immediately via the object “reply switch status” when there are any changes on the output.

If selecting “respond always”, no matter it’s reading, or there is change for the status, as long as the controlling telegram can be received, the object will send the current status to the bus.

Parameter “Object value of switch status :”

Options:

0=contact close; 1=contact open

1=contact close; 0=contact open

It means the contact of the relay will be closed when the value of the communication object “reply switch status” is 0 when setting “0=contact close; 1=contact open”, while it is open when the value is “1”.

It means the opposite with setting “0=contact open; 1=contact close”.

Note: After programming or bus recovery, if the switch status is determined, the object “switch status” will send status to the bus. If not, it will not be sent.

Parameter “Contact position if tele. Value is ‘1’ (‘0’ is opposite of ‘1’ if changed) ”

This parameter defines the contact position when switch on the switch, which will be triggered by the communication object “switch, X”. When enabling “input 0” in the logic function, it will use the communication object “switch, X” to modify the value of “input 0”, rather than triggering the switch operation.

The parameter setting will affect the channel action of the central control. Options:

Open

Close

The parameter only works after the object “Switch x” receiving value, and defines the direction of the contact after receiving it. The details can be found in the below form:

Parameter options	“Switch, X” object value =1	“Switch, X” object value =0
Open	Contact open(OFF)	Contact close (ON)
close	Contact close (ON)	Contact open (OFF)

Since the switch and logic functions share the same object “switch, X”, thus need to understand the relationship between them, the control sequence shown below (the logic functions, please refer to the following chapter describe):

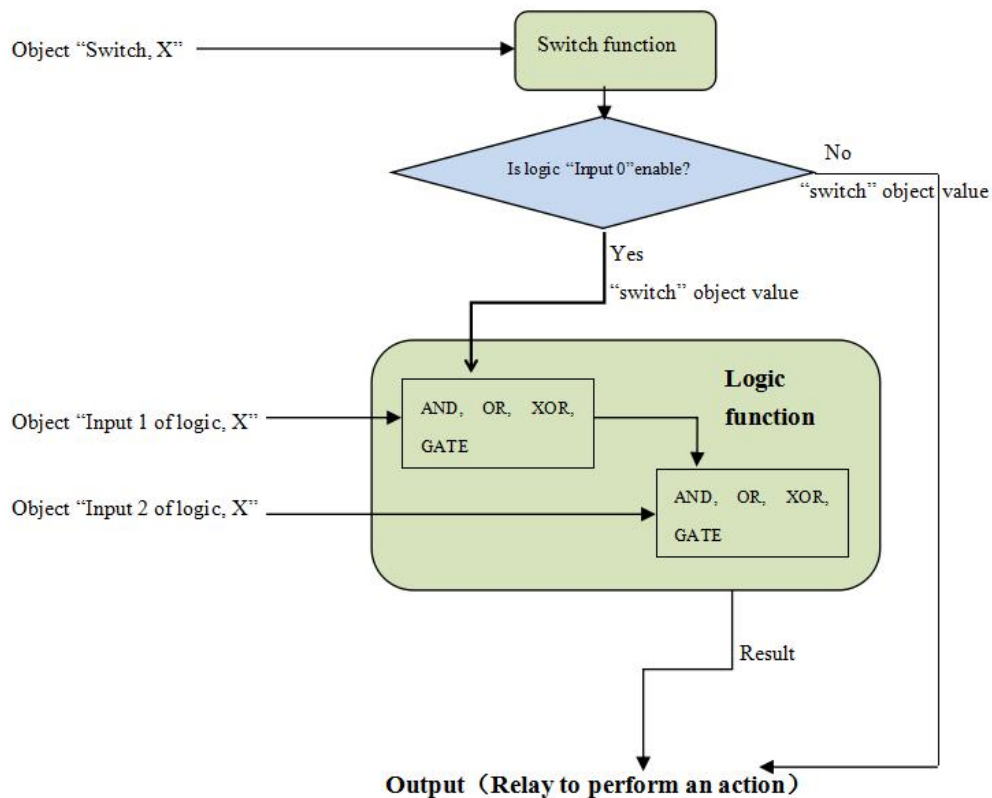

Switch and logical function diagram

When the logic function “input 0” enables, the object “switch, X” used as input of “input 0”, the operation of general switch will become invalid. Note: The central switch can still control the output.

Parameter “Special functions of switch actuator mode”

This parameter defines whether enable the special functions of the switch actuator. The parameter window “X: Function” will be seen with “enable”, and able to set the special functions individually in Fig. 4.4. Enable or disable the special function in “X: Function”.

Options:

Disable

Enable

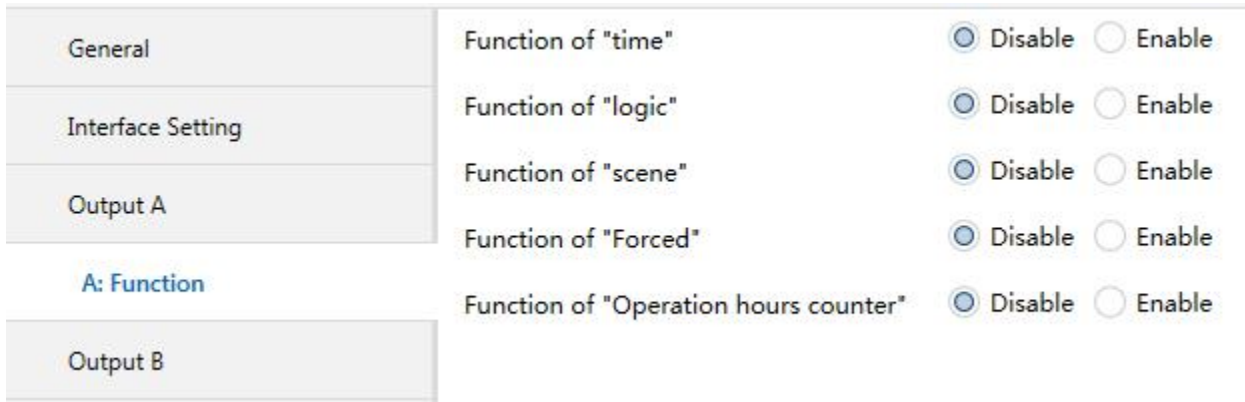

Fig. 4.4 the special function enable window “X: Function”

4.3.2 Parameter window “X: Time”

This parameter window will become visible when selecting “enable” in the parameter “Function of “time” ” in the window “X:Function” shown in Fig. 4.4. See Fig. 4.5. And the object “enable time function” will be also visible, which is used to disable the time function. After disabled, previous operation is still carried out completely. Such as switch on delay, the function is disabled during delay, and then the switch is still switched on once the delay has been finished.



Fig. 4.5 parameter window “X: Time-Delay ”

Parameter “Type of time function”

The parameter defines the type of the time function, there are three options for the mode of work. Options:

Delay

Flashing

Staircase

4.3.2.1 Selection “Delay”

The parameter window of the delay switch in Fig. 4.5 will be shown when selecting “Delay”. The delay switch can be started via the object “Delay function”.

Parameter “Delay for switch on: (0...240 min)/ (0...59 s)”

This parameter defines the delay time of switching on.

Options:

0...240 min

0...59s

After receiving the delay ON telegram, the switch is on once the delay over.

Parameter “Delay for switch off: (0...240 min) / (0...59 s)”

This parameter defines the delay time of switching off.

Options:

0...240 min

0...59 s

After receiving the delay off telegram, the switch is off once the delay over.

If receiving the relevant telegram again during delay, the delay will be reset.

4.3.2.2 Selection “Flashing”

The parameter window in Fig. 4.6 “X: Time-flashing” will be shown up when selecting “Flashing” in the parameter “Type of time function”. The flashing switch function is mainly used for lamp aging test.

General	Type of time function	Flashing
Interface Setting	Delay for switch on: --(0...240min)	0
Output A	--(0...59s)	0
A: Function	Delay for switch off: --(0...240min)	0
A: Time	--(0...59s)	0
Output B	Number of ON-implused (1...255,0=no limited)	0
Output C	Contact position after flashing	Unchange
	The control mode of flashing	Start with "1",Stop with "0"

Fig. 4.6 parameter window “X: Time-Flashing”

The flashing switch can be started via the object “Flashing function”. It is able to set the flashing time in “Delay for switch on” or “Delay for switch off”, which will restart the flashing when receiving the start flashing telegram, and define the contact position after flashing.

Parameter “Delay for switch on: (0...240Min), (0...59s)”

The parameter defines the duration time of switch on the output when flashing.

Options:

0...240 min

0...59 s

Note: it will not be executed unless the time is lower than the relay threshold switch frequency. Since there will be not sufficient energy to do it because of the frequent relay switching, and it may cause the time delay. The same situation will happen after the bus voltage recovery.

Parameter “Delay for switch off: (0...240Min), (0...59s)”

The parameter defines the duration time of switch off the output when flashing. Options:

0...240 min

0...59 s

Note: it will not be executed unless the time is lower than the relay threshold switch frequency. Since there will be not sufficient energy to do it because of the frequent relay switching, and it may cause the time delay. The same situation will happen after the bus voltage recovery.

Parameter “Number of ON-impulses (1...255, 0=no limited)”

This parameter sets the flashing times. 0 means no limited. A flashing includes an on and an off actions.

Options: 0...255

Parameter “Contact position after flashing”

This parameter defines the relay contact position after flashing. Options:

Unchanged

Open

Close

Parameter “Control mode of flashing”

The parameter is used to select the control mode of the flashing output. Options:

Start with “1”, stop with “0”

Start with “0”, stop with “1”

Start with “1/0”, can not be stopped

It will start flashing with value “1” when selecting “star with “1”, stop with “0””; it will stop flashing with “0”. The stop position is defined via last parameter.

It will start flashing with value “0” when selecting “star with “0”, stop with “1””; it will stop flashing with “1”. The stop position is defined via last parameter.

It will start flashing with either “1” or “0” when selecting “star with “1/0”, can not be stopped”; Under this circumstance it cannot terminate the flashing by value until operation over or it is blocked by other operation.

4.3.2.3 Selection “Staircase”

The parameter window of the staircase lighting function in Fig. 4.7 will be visible when selecting “Staircase” in the parameter “Type of time function”.

General	Type of time function	Staircase
Interface Setting	Duration of staircase lighting: -- (0...1000min)	1
Output A	--(0...59s)	0
A: Function	Control mode of staircase lighting	Start with "1",Stop with "0"
A: Time	During the lighting time,if receive the "start" telegram	<input checked="" type="radio"/> Restart duration of staircase lighting <input type="radio"/> Ignore the "start" telegram

Fig. 4.7 parameter window "X: Time-Staircase"

The staircase lighting can be started via the object "staircase function". The value that switches on the staircase lighting can be set via a parameter. The duration time of the lighting on is also set via a parameter.

Parameter "Duration of staircase lighting--(0...1000 min) --(0...59 s)"

This parameter describes the duration time when switching on the staircase lighting. Options:

0...1000min

0...59s

Parameter "Control mode of staircase lighting"

This parameter defines the control mode on/off of the staircase lighting. Choose suitable control mode according to the needs. Options:

Start with "1", stop with "0"

Start with "1", no action with "0"

Start with "0/1", cannot be stop

Start with "1", Off with "0"

When selecting "Start with "1", stop with "0"", it will switch on the staircase lights with the value "1"; it will stop the time counting operation with "0" and don't change the contact position until changed by other operations.

When selecting "Start with "1", no action with "0"", it will switch on the staircase lights with the value "1" and no reaction with "0".

When selecting "Start with "0/1", cannot be stopped", it will switch on the staircase lights either with "0" or "1" but cannot stop it until the duration time finished or changed by other operation.

When selecting "Start with '1', off with '0'", it will switch on the staircase lights with the value "1", and off with "0".

Parameter "During the lighting time ,if receive the 'start' telegram"

Options:

restart duration of staircase lighting

Ignored the "switch on" telegram

If selecting "restart duration of staircase lighting", if the object "Staircase function" again receive the telegram of starting staircase lighting during the duration time, then the staircase lighting will restart and the duration time will be restart.

If selecting "Ignored the 'switch on' telegram", then it will ignore the receiving telegram of the object "Staircase function" during the duration time.

4.3.3 Parameter window “X: Logic”

Parameter window of logic function shown in Fig. 4.8, it will shown up in Fig. 4.4 “X: Function” when selecting “enable” in “Function of “logic” ”.

General	Enable input 0	<input type="radio"/> Disable <input checked="" type="radio"/> Enable
Interface Setting	Input 0 reverse	<input checked="" type="radio"/> No <input type="radio"/> Yes
Output A	The input 1 of logic	<input type="radio"/> Disable <input checked="" type="radio"/> Enable
A: Function	Logic function type	AND
	Input 1 reverse	<input checked="" type="radio"/> No <input type="radio"/> Yes
	Result reverse	<input checked="" type="radio"/> No <input type="radio"/> Yes
	Value of input 1 after bus recovery	0
A: Logic	The input 2 of logic	<input type="radio"/> Disable <input checked="" type="radio"/> Enable
Output B	Logic function type	AND
Output C	Input 2 reverse	<input checked="" type="radio"/> No <input type="radio"/> Yes
Output D	Result reverse	<input checked="" type="radio"/> No <input type="radio"/> Yes
Output E	Value of input 2 after bus recovery	<input checked="" type="radio"/> 0 <input type="radio"/> 1
Version		

Fig. 4.8 parameter window “X: Logic”

There are 2 logic communication objects to decide the status of each output, which are related to the “Switch”, as shown in fig. 4.4

It will re-operate when receiving a new object value as the final output status (close the contact with “1”, open it with “0”). The values of the communication object “Input 1 of logic” makes logic operation with “Switch” firstly, and then the result after that will makes operations with the value of “Input 2 of logic”. This operation will ignore the objects which are unable, and continue to the next step with the ones who are enabled.

Parameter “Enable input 0”

This parameter is used to enable the function of logic operation of “input 0”, whose values are wrote by the object “Switch”. Options:

Disable

Enable

In the both cases of input 0 enabled and not enabled, there are a little different parameters. All parameters of logic function have described in the following. If input0 is disabled, the parameters will be less. If there are not certain parameters in the case, then it is also not available with the function of these parameters.

Parameter “Input 0/1/2 reverse”

This parameter defines whether negate the input value. Negate it with “yes”, don’t with “no”. Options:

No

Yes

Parameter “Input x of Logic” (x = 1, 2)”

This parameter is used to enable input1 and input 2. If enable, their communication objects “logic 1” and

“logic 2” will be also visible. Options:

Disable

Enable

Parameter “Logic function type”

This parameter set logic function type, provided three standard logic operations : AND, OR ,XOR, and a GATE function. Explanation of gate function: it will use the next logic value as the enable mark of the previous logic. If the enable mark of the next logic is “1”, that means it is able to use the previous logic value as the operation result. E.g. the value of input 1 is 1, that means the value of input 0 can be used as the operation result; if the value of input 2 is 1, that means the operation value of input 0/1 can be used as the result. Options:

AND

OR

XOR

Gate function

Below result of logic operation is possible:

Logic function	Object values					Description
	Input0 (Switch)	Input1	Result of Input0/1	Input2	Output	
AND	0	0	0	0	0	The result is 1 if both input values are 1.
	0	1	0	1	0	
	1	0	0	0	0	
	1	1	1	1	1	
OR	0	0	0	0	0	The result is 1 if one of both input values is 1.
	0	1	1	1	1	
	1	0	1	0	1	
	1	1	1	1	1	
XOR	0	0	0	0	0	The result is 1 if both input values have a different value.
	0	1	1	1	0	
	1	0	1	0	1	
	1	1	0	1	1	
GATE	0	Closed		Closed		The input0 of value is only allowed through if the GATE (input 1 and input 2) is open. Otherwise the input0 of value is ignored.
	0	Open	0	Open	0	
	1	Closed		Closed		
	1	Open	1	Open	1	

Note:

1. The values of the communication object “Input 1” makes logic operation with “Switch” firstly, and then the result will makes operations with the value of “Input 2”, and the final operation result as the final output (close the contact with “1”, open it with “0”).
2. If an input is not enabled, this input is ignored.
3. If logic result needs to be negated, the first negated, then the next step.
4. The signal can be passed if the GATE is open, otherwise it is ignored. For example, the input 0 of value is ignored when the GATE of input1 is closed, and the output is directly determined by the input2.

Parameter “Result reverse”

This parameter defines whether negate the logical operation results. Negate it with “yes”, don’t with “no”. Options:

No

Yes

Parameter “Value of input 1 after bus recovery”

This parameter defines the default value of the object “Logic1” after bus voltage recovery. Options:

0

1

Value before power off

Parameter “Value of input 2 after bus recovery”

This parameter defines the default value of the communication object “Logic 2” after bus voltage recovery, “1” or “0” is optional. Options:

0

1

4.3.4 Parameter window “X: Scene”

The parameter window shown in Fig. 4.9 will be visible when selecting “enable” in “Function of “scene” ” in Fig. 4.4. Here can set 8 scenes.

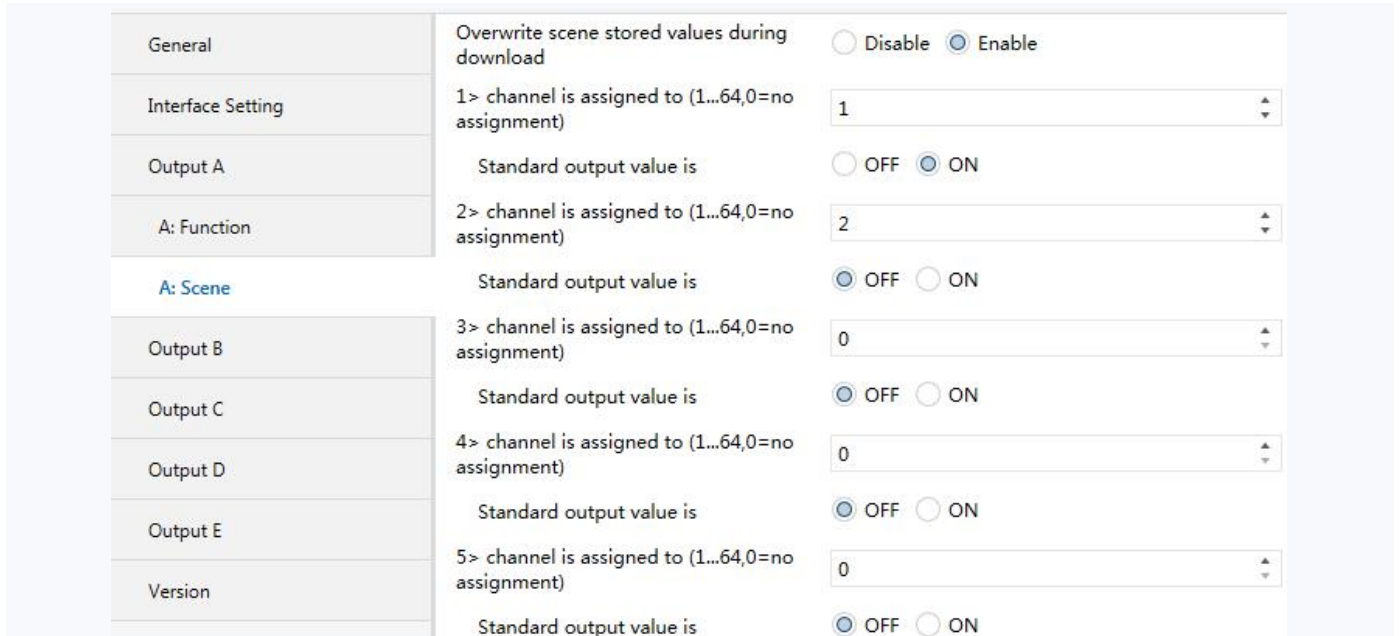

Fig. 4.9 parameter window “X:Scene”

Parameter “Overwrite scene stored values during download”

Options:

Disable

Enable

If selecting “Disable”,the stored values before the download can be not overwritten by the parameterized scene value.

If selecting “Enable”,the stored values will be overwritten by the parameterized scene value during the download .

Parameter “channel is assigned to (1...64 ,0= no assignment)”

It is able to allocate 64 different scene numbers to every output. There are 8 various scenes can be set per output. Options: Scene 1... Scene 64 , 0=no assignment

Note: 1-64 in the parameter setup corresponds to the scene number 0-63 received by the communication object “Scene” . If a scene is modified, the new scene will be stored when power off.

Parameter “--Standard output value is”

This parameter defines the switch output status when recall the scene. Options:

OFF

ON

4.3.5 Parameter window “X: Forced”

The window of the function “forced” in Fig. 4.10 “X: Function” will be visible with “enable” in the parameter “Function of “Forced” ” in Fig. 4.4.

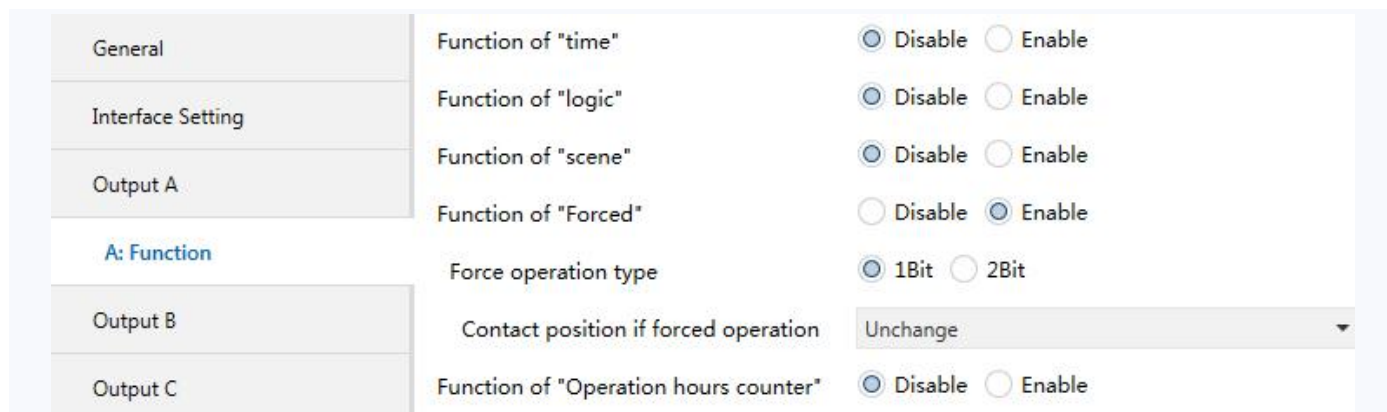

Fig. 4.10 parameter window “X: Forced”

This function will be used in some special situation such as emergency, and are activated by the object “Forced output” with the highest priority in the system, which means only “forced operation” are valid in this case.

Parameter “Force operation type”

The parameter defines the control type of force operation. Options:

1bit

2bit

If selecting “1bit”, object “Forced output” receives telegram “1” to activate force operation, telegram “0” to cancel the force operation.

If selecting “2bit”, when the object “Forced output” receives a telegram value, the action as follow:

Value of object “Forced output, X”	Action
00b (0) , 01b (1)	Cancel force operation, other operation can be performed.
10b (2)	Force switch off
11b (3)	Force switch on

When cancel the forced operation, the position of relay contact is unchanged.

Parameter “Contact position if forced operation”

The parameter is visible if the option “1bit” is selected via last parameter, which defines the contact position of force operation. Option:

Unchange

Open

Close

The forced operation has the highest priority, and all the other operations are ignored during the forced operation.

4.3.6 Parameter window “X: Operation hours counter”

The window of the function “Operation hours counter” in Fig. 4.11 will be visible with “enable” in the parameter “Function of “Operation hours counter” ” in Fig. 4.4. The function is use for counting the time of relay on.

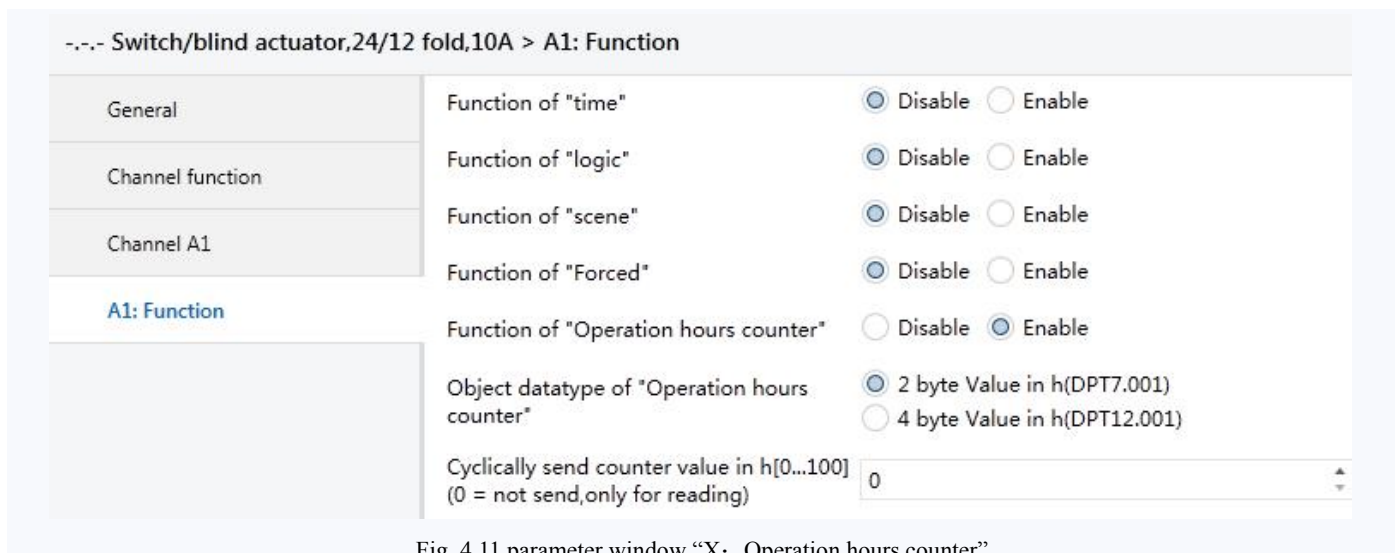

Fig. 4.11 parameter window “X: Operation hours counter”

Parameter “Object datatype of “ Operation hours counter”

This parameter is used to select data type of the operation hours counter. Options:

2 byte Value (DPT 7.001)

4 byte Value (DPT 12.001)

Parameter “Cyclically send counter value in h[0..100] (0=not send, only for reading)”

The parameter determines the time interval to send the telegram which is used for counting the time of relay on . Option: 0-100

“0” means do not send. “1-100” means 1 hours to 100 hours cyclically send the value.

4.4 Fan coil controller

4.4.1 Parameter window “HVAC General”

The “HVAC General” parameter window is shown in Figure 4.12. The controller can be defined as local control or bus control according to requirements, as shown in the figure below.

This parameter window mainly sets some basic parameters of the coil controller. The specific description of each parameter is as follows.

General	Controller define	<input checked="" type="radio"/> Local <input type="radio"/> Bus
Interface Setting	Heating or Cooling switch by	<input type="radio"/> Local <input checked="" type="radio"/> Bus
HVAC-General	Number of Heating/Cooling switch object	<input checked="" type="radio"/> 1 object <input type="radio"/> 2 objects
Temperature	Insensitive zone between heating and cooling	1°C
Setpoint	Minimum changeover time between heating and cooling*min[0...255] (0=inactive)	5
Heating/Cooling valve (Relay)	2-point control method setting	
Scene	Lower Hysteresis*0.1°C[0...200] (for heating)	10
Output A	Upper Hysteresis*0.1°C[0...200] (for cooling)	10
Output B	PI control method setting	
Output C	Heating speed	Normal(12000/900)
Output E	Cooling speed	Normal(12000/900)
Version		

Fig. 4.12 Parameter window "HVAC General -- Local"

General	Controller define	<input type="radio"/> Local <input checked="" type="radio"/> Bus
Interface Setting	Number of control value	<input checked="" type="radio"/> 1 control value with switching object <input type="radio"/> 2 control value
HVAC-General	Control value object type	<input checked="" type="radio"/> 1bit <input type="radio"/> 1byte
Temperature	Monitoring control value	<input type="radio"/> No <input checked="" type="radio"/> Yes
Heating valve (Relay)	Monitoring period of control value*s [10...65535]	60
Cooling valve (Relay)	Reply mode of Obj*Control value fault" 1bit function	Respond after change
Fan	Control value after fault occurs[0...100]%	20
Auto.operation		

Fig. 4.12 Parameter window "HVAC General -- Bus"

Parameter “Controller define”

This parameter is used to set the source of pipe controller. Options:

Local

Bus

Local: the cooling and heating is controlled via the output control of controller, that is, to be control equipment, to control the valve.

Bus: the cooling and heating is controlled via external input, that is, to be controlled equipment, the valve only can be controlled via external input (e.g. thermostat panel).

Note: Due to the different control methods, the parameters setting of database are also different. The following content are consist of the parameters setting of “Local” and “Bus”.

4.4.1.1 Local

Parameter “Heating or Cooling switch by”

This parameter is in Interface 4.2, the parameter “HVAC-System” is visible while “2 pipes system” is selected, to set the Heat and Cool switch methods in the case of 2 pipes system. Options:

Local

Bus

Local: determine the output control is heating or cooling according the actual temperature and setting parameter, while switch the object 46 “Heating/Cooling mode” will send the status to the bus.

Bus: the heating and cooling is controlled via external input. While “Bus” is chosen, the following parameter is visible.

Parameter “Number of Heating/Cooling switch object”

The parameter define the Number of Heating/Cooling Object. Options:

1 object

2 objects

1 object: determine the water of pipe is cold water or hot water through the object “Switch Heating/Cooling Mode”, while receiving telegram “1”, switch to heating; while receiving telegram “0”, switch to Cooling.

2 objects: determine the water of pipe is cold water or hot water through object “Heating mode enable” and “Cooling mode enable”, while receiving telegram “1”, switch to the corresponding operation; while receiving telegram “0”, it is invalid.

Parameter: Insensitive zone between heating and cooling

This parameter is visible while “Heating and cooling” is selected on “HVAC Control mode”.

It is used to set the insensitive zone automatically switch between heating and cooling.

The smaller the insensitive zone value is, the faster the response of switching heating and cooling, that is, the more frequent of switching heating and cooling;

The bigger the insensitive zone value is, the switching heating and cooling will less, to save energy, however the response of switching and cooling will slower.

Options: 0.5...6.0 [°C]

For the usage of Insensitive zone please refer to the section 4.4.3.1 Setting Temperature adjustment instruction.

Parameter“Minimum changeover time between heating and cooling [0..255]*min, 0=inactive”

This parameter is used to set the changeover time between heating and cooling, mainly for prevent frequent change heating and cooling.

Options: 0...255[min.]

2-point control method setting: the following two parameters apply to 2-point control method.

——Parameter“Lower Hysteresis [0..200]*0.1℃” (For heating)

——Parameter“Upper Hysteresis [0..200]*0.1℃” (For cooling)

The parameter is to set the temperature hysteresis value of HVAC heating and cooling. Options: 0..200

In the case of heating, while actual temperature(T) > setting temperature, stop heating;

While actual temperature <= setting value- Lower Hysteresis, start heating.

For example, while hysteresis is 3℃, setting temperature is 22℃, when T exceeds 22℃, stop heating;

When T smaller than 19℃, start heating; while T is between 19~22℃, remain the working status as previous.

In the case of cooling, while actual temperature(T) < setting temperature, stop cooling;

While actual temperature >= setting value+ Upper Hysteresis, start cooling.

For example, while hysteresis is 3℃, setting temperature is 26℃, when T lower than 26℃, stop cooling;

When T more than 29℃, start cooling; while T is between 29~26℃, remain the working status as previous.

PI control method setting: the following two parameters apply to PI control method.

——Parameter“Heating speed”

——Parameter“Cooling speed”

The parameter is used to set the response speed of heating and cooling PI control.Options:

Slow (12000/1800)

Normal (12000/900)

Fast (12000/450)

User defined

Parameter“Proportional range (P value) 0...65,535”

Parameter“Readjust time (I value) (0...65,535)*s ”

The above parameters are visible while “User defined” is selected on parameter “Heating/Cooling speed”. They are used to set the P value and I value of PI controller.

4.4.1.2 Bus

Parameter "Number of control value"

This parameter will visible while "4 pipes system" is selected on parameter "HVAC-System".

It is used to set the number of external input control valve. Options:

1 control value with switching object

2 control values

1 control value with switching object: control the Heating valve and Cooling valve via one object(object 34). Switch Heating and Cooling via object "Switch Heating/Cooling mode"(Object 30);

2 control values: heating valve and cooling valve have their own objects (object 34 and object 38)

Parameter "Control value object type"

This parameter is to set the control value object type. The local heating/cooling valve will be controlled by the received the control value. Options,

1 Bit

1 Byte

1Bit: the control value of external input is 1Bit

1Byte: the control value of external input is 1Byte

Parameter "Monitoring control value"

This parameter is for monitoring control value of external input. Options:

No

Yes

While "yes" is selected, the following parameters are visible.

—Parameter "Monitoring period of control value[10..65535]*s

The parameter is used to set the monitoring period of control value, if it can not receive control value during the period, the controller will consider the external controller error, it will output according the next parameter setting value. Options: 10...65535s

—Parameter "Reply mode of Obj. "Control value fault"1bit function"

The parameter defines the reply mode of Obj. "Control value fault"Options:

Respond after read only

Respond after change

Respond after read only: respond after read only the device receiving the device from bus or other bus, Object "Control value fault" respond the current status to the bus.

Respond after change: while error change or the device receiving the request of read status, object "Control value fault" will send telegram to respond the current status to bus.

Parameter “Control value after fault occurs [10..100] %”

While the external controller error, the controller will adjust valve according the parameter setting value.
Options: 0...100 %

Tips:

- 1.The controller define as local, the control fault is 0 while the temperature sensor error.
- 2.The control value is influence via the Valve characteristic curve adjustment parameter.

4.4.2 Parameter window “Temperature”

The “Temperature” parameter window is shown in Figure 4.13. The relevant parameters for temperature detection are set under this interface.

General	Temperature measure by	Local and External sensor combination
Interface Setting	Combination ratio	50% Local to 50% External
HVAC-General	Temperature calibration for local sensor*0.1°C[-50..50]	0
Temperature	Time period for requesting external sensor[0..255]*min	1
Heating valve (Relay)	Reply error of local sensor measurement	No respond
Cooling valve (Relay)	Object value of error	<input checked="" type="radio"/> 0=no error/1=error <input type="radio"/> 1=no error/0=error
Fan	Send actual temperature to bus	<input type="radio"/> No <input checked="" type="radio"/> Yes
Auto.operation	Send temperature when the result change by*0.5°C[1...20]	4
Fan status	Cyclically send actual temperature[0..255]*min	10

Fig. 4.13 Parameter Setting Interface“Temperature ”

Parameter “Temperature measure by”

Options:

Disable

Local sensor

External sensor

Local and External sensor combination

Local sensor: The temperature value measured by the temperature sensor of this device is sent or read to the bus by the object "Actual temperature output"; when the temperature sensor is faulty, the temperature value will be 0.

External sensor: The temperature value is measured by other temperature control devices on the bus and is received by the object "External sensor". When the device does not receive the measurement value of the external sensor, the control value will be 0 in case of the local controller.

Local and External sensor combination: the built-in temperature sensor and the external sensor will measure the temperature value in combination method. When the device does not receive the measurement value of the external sensor, the temperature will be the value detected by the built-in temp. sensor.

Parameter "Combination ratio"

Options:

10% Local to 90% External

...

90% Local to 10% External

This parameter is available when the "Internal and External sensor combination" is activated in the above parameter. It is used to set the combination ratio of the temperature value from the internal temperature sensor and the temperature value from the KNX bus. For example, if the "40% Internal to 60% External" is activated, the temperature value from the internal sensor(A) takes 40% and the temperature value from the external sensor(A) takes 60%. Then the actual value of the sensor = (A×40%) + (B×60%)

Parameter "Temperature calibration for local sensor [-50..50]*0.1°C"

Options: -50..50

This parameter is used to set the temperature correction value of the temperature sensor of the device, that is, the measured value of the temperature sensor is corrected to be closer to the current ambient temperature.

Parameter "Time period for requesting external sensor [0..255]min"

This parameter is visible when the sensor type selects "External sensor" and is used to set the time period during which the device sends a read request to the external temperature sensor. Options: 0..255

Parameter "Reply error of local sensor measurement"

This parameter defines the feedback method for the error of the temperature sensor of this device. Options:

Respond after read only

Respond after change

Respond after read only: The object "Local sensor error output" sends the current status to the bus only when the device receives a status read from another bus device or bus.

Respond after change: When the error status changes or the device receives a request to read the status, the object "Local sensor error output" immediately sends a message to the bus to report the current status.

Parameter "Object value of error"

This parameter defines the object value of the device's temperature sensor error. Options:

0=no error/1=error

1=no error/0=error

0=no error/1=error: When there is no error in temperature detection, the object "Local sensor error output" sends the message "0". When an error occurs, the object sends the message "1"; vice versa.

Parameter "Send actual temperature to bus"

This parameter sets whether to send the current actual temperature to the bus. Options:

No

Yes

Yes: the follow two parameters and the object "Actual temperature output" are visible.

Parameter "Send temperature when the result change by[1..20]*0.5°C"

This parameter sets the current temperature value to the bus when the temperature changes by a certain amount. Options: 1...20

Parameter "Cyclically send room temperature [0..255]min"

This parameter sets the time that the actual temperature value cyclically sent to the bus. Options: 0..255min

The timing starts from the time of programming completion or reset, and the current temperature value will be reported to the bus when the timing period expires.

4.4.3 Parameter window "Setpoint"

The parameter window "Setpoint" is as shown in the figure 4.14.

The window is visible while "Local" is selected on parameter "Controller define" in the figure 4.12.

Mainly set the basic parameter of heating and cooling, the parameter of "Heating" and "Cooling" will appear while selecting the corresponding heating or cooling in the figure 4.2. There is the specific introduction of setting of each parameter.

General	Base setpoint temperature(°C)	20
Interface Setting	When bus recovery,controller status	Comfort mode
HVAC-General	Extended comfort mode*min (0=inactive,1-255 is valid)	30
Temperature	Operating mode switchover	<input checked="" type="radio"/> 1bit <input type="radio"/> 1byte
	Operating mode status	<input type="radio"/> 1bit <input checked="" type="radio"/> 1byte
Setpoint		
Heating valve (Relay)	Heating Reduced heating in standby mode [0...10] °C	2
Cooling valve (Relay)	Reduced heating during night mode [0...10] °C	4
Fan	Actual temperature threshold in frost protection mode[2...10] °C	7
Fan status	Limit value for setpoint heating [5...40]°C	35
Scene	Cooling	
Output A	Increased cooling in standby mode [0...10] °C	2
Output B	Increased cooling during night mode [0...10] °C	4
Output C	Actual temperature threshold in heat protection mode[5...40] °C	40
Version	Limit value for setpoint cooling [5...60]°C	15

Fig. 4.14 Parameter Window“Setpoint”

Parameter“Base setpoint temperature(15..30)°C”

The parameter is used to set the base setpoint temperature,producing the setpoint temperature of room mode. Options: 15...30 [°C]

Parameter“When power recovery, Controller status”

This parameter is used to set the controller status when power recovery, the controller status are Standby mode, Comfort mode, Night setback and Frost/heat protection. Options

Standby mode

Comfort mode

Night setback

Frost/heat protection

Parameter“Extended comfort mode[1..255, 0=inactive]*min”

This parameter is used to set the delay time of Comfort mode. Options: 0...1-255 [min.]

While the set value is “0”, meaning do not use the delay time function of Comfort mode.

While the set value is 1-255, it comes to effect while the room mode shift from Night mode to Comfort mode.

The Comfort mode will automatically switch back to Night mode after the delay time. This parameter is only for the switching between Night mode and Comfort mode.

Parameter“Operating mode switchover”

This parameter is used to set the Object type of operating mode switchover. Options:

1bit

1byte

While select “1bit”, 4 object 1bit are visible, which will switch different mode depending on it's ON or OFF.

The 4 objects are Comfort mode, Night mode, standby mode and Frost/heat protection mode, while the value of them all are “0”, the operating mode is standby mode.

Priority should be note while switching, Frost/heat protection mode has highest-priority, the other modes have the same priority.

Thus, before entering a mode with a low priority, the mode with a higher priority should be turn off.

While select “1byte”, 1 means Comfort mode, 2 means standby mode, 3 means Night mode, 4 means Frost/heat protection mode, it will shift to the corresponding mode according the received telegram value.

Parameter“Operating mode status”

This parameter is used to set the room operation mode status. Options:

1bit

1byte

While select “1bit”, 4 object 1bit are visible. The 4 objects are Comfort mode, Night mode, standby mode and Frost/heat protection mode, while a certain mode is activated, the corresponding object will send telegram “1”, otherwise, it is “0”.

While select 1byte, the sending telegram value:1 means Comfort mode, 2 means standby mode, 3 means Night mode, 4 means Frost/heat protection mode.

Heating / Cooling

These parameters are used to set the room's temperature set value in various operation mode.

Parameter“Reduced heating in standby mode [0..10]°C”**Parameter“Increased cooling in standby mode [0..10]°C”**

This parameter is used to set the temperature set value on Standby mode. Options: 0...10 [°C]

Heating: the temperature set value of Standby mode is base value minus setting value;

Cooling: the temperature set value of Standby mode is base value plus setting value;

Parameter“Reduced heating during night mode [0..10]°C”**Parameter“Increased cooling during night mode [0..10]°C”**

This parameter is used to the temperature set value on Night mode. Options: 0...10 [°C]

Heating: the temperature set value of Night mode is base value minus setting value;

Cooling: the temperature set value of Night mode is base value plus setting value.

Parameter“Actual temperature threshold in frost protection mode [2..10]°C”

This parameter is used to set the temperature set value in frost protection mode. Options: 2...10 [°C]

In frost protection mode, when the room temperature drops to the value sets by this parameter, the fan coil controller will output control to prevent the temperature from falling below this temperature setting value.

For example, when the setting temperature is 5°C, while the room temperature lower than 5°C, the fan coil controller will output to maintain the room temperature at 5°C or so for protection.

Parameter“Actual temperature threshold in heat protection mode[5..40]°C”

This parameter is used to set the temperature setting value in heat protection mode. Options: 5...40 [°C]

In heat protection mode, when the room temperature rises to the value sets by this parameter, the fan coil controller will output control to prevent the temperature from being higher than this temperature setting value.

For example, when the setting temperature is 30°C, while the room temperature higher than 30°C, the fan coil controller will output to maintain the room temperature at 30°C or so for protection.

Parameter“Limit value for setpoint Heating [5...40]°C”**Parameter“Limit value for setpoint Cooling [5...60]°C”**

The above parameters are used to set the limit value on heating and cooling.

Heating: The temperature setting value can not higher than this limit value, if higher, it will output as this limit value;

Cooling: The temperature setting value can not lower than this limit value, if lower, it will output as this limit value.

4.4.3.1 Temperature setting adjustment instruction

The corresponding setting of temperature setting can be set on the parameter window “Setpoint”.

The actual output of setting temperature can be accounted as follows,

In Comfort mode:

Heating: Actual setting temperature= basic value setting temperature+setting temperature adjustment value.

2-pipe system mode cooling: actual setting temperature=basic value setting temperature+ setting temperature adjustment value.

4-pipe system mode cooling: actual setting temperature=basic value setting temperature+setting temperature adjustment+Insensitive zone temperature.

In Standby mode:

Heating: actual setting temperature=basic value temperature- decrement in standby mode+setting temperature adjustment value.

Cooling: actual setting temperature=basic value temperature + increment in standby mode+setting temperature adjustment value.

In night mode:

Heating: actual setting temperature=basic value temperature- decrement in night mode+setting temperature adjustment value.

Cooling: actual setting temperature=basic value temperature + increment in night mode+setting temperature adjustment value

In Frost/heat protection:

Heating: actual setting temperature=heat protection setting temperature.

Cooling: actual setting temperature=frost protection setting temperature.

Setting temperature adjustment value can amend through object 5 “Setpoint adjustment”.

Actual temperature setting value will be sent after object 6 read the request.

Note:

when “Heating and cooling” is chose on “HVAC Control mode”, the automatic control switching heating and cooling is only related to the setting temperature in Comfort mode, that is, heating or cooling is obtained after comparison between setting temperature and actual temperature. That is while the actual temperature is larger than setting temperature at cooling, it shift to cooling; while the actual temperature is smaller than setting temperature at heating, it shift to heating.

4.5 Fan control

The below parameters are basically same whatever the driver interface of fan control is relay or 0-10V. The function of each parameter will be described in detail below.

4.5.1 Parameter window“Fan type -- One level”

The parameters of “Fan type -- One level” are setting as shown in figure 4.15, to set the parameter of one level fan. The parameter setting is shown as follows:

General	Fan type	<input checked="" type="radio"/> One level <input type="radio"/> Multi-level
Interface Setting	When bus failure,Fan speed is	Unchange
HVAC-General	When bus recovery, fan speed is	Unchange
Temperature	After downloading, fan speed is	OFF
Setpoint	"Forced operation" function	<input type="radio"/> Disable <input checked="" type="radio"/> Enable
Heating valve (Relay)	Forced operation on object value	<input type="radio"/> 0=Force/1=Cancel <input checked="" type="radio"/> 1=Force/0=Cancel
Cooling valve (Relay)	Behaviour on Forced operation	Unchange
	Auto. operation function (only for HVAC)	<input checked="" type="radio"/> Disable <input type="radio"/> Enable
Fan	Time mode for function ON	Switch Delay
Fan status	Delay time*0.1s[1...65535]	10
Scene	Time mode for function OFF	Minimum time
	Minimum time*s[1...65535]	10

Fig. 4.15 Parameter window“Fan type -- One level”

Parameter“Fan type is”

This parameter define the fan type which would be controlled. Options,

One level

Multi-level

One level: can control the fan with one level fan speed.

Multi level: can control the fan as many as three levels fan speed, it can choose 2 level, but also can choose 3 level.

Parameter“When power failure, Fan speed is”

This parameter defines the fan speed when power failure. Options,

Unchange

OFF

ON

Note: in 0-10V control port mode, the port outputs 0V when power failure.

Parameter“When power recovery, Fan speed is”

This parameter defines the fan speed when power recovery. Options,

Unchange

OFF

ON

As before as bus fail

Unchange: the status do not change;

OFF: turn off fan;

ON: turn on fan;

As before as bus fail: the status before power failure.

Note: It is advised to connect the bus and the auxiliary supply voltage firstly before connecting fan, to avoid possibility of damage for fan due to incorrect connection.

Parameter "After downloading, fan speed is"

This parameter notes the fan will be turn off after downloading.

Parameter "Forced operation function"

This parameter is used to enable the forced operation function. Options,

Disable

Enable

If "Enable", the 1 bit communication object "Forced operation" will visible, the following two parameter will also visible, for setting the object value and the action of "Forced operation".

—Parameter "Forced operation on object value is"

This parameter is used to activate the object value of forced operation. Options,

0=Force/1=Cancel

1=Force/0=Cancel

0=Force/1=Cancel: when object "Forced operation" receiving value "0", activate force operation. When receiving "1", cancel force operation;

1=Force/0=Cancel: when object "Fan Forced operation" receiving value "1", activate force operation. When receiving "0", cancel force operation.

—Parameter "Behaviour on Forced operation is"

This parameter defines how the fan should respond with the Forced operation. Options:

Unchange

ON

OFF

Unchanged: the current speed is remained.

ON: the fan is switched on.

OFF: the fan is switched off.

The Forced operation has the Second highest priority, so its action is influenced by the minimum time and switching delay of the follow parameter setting.

Parameter "Auto. Operation function (only for HVAC)"

This parameter is used to enable/disable the auto. Operation of the fan. The options:

Disable

Enable

Enable: with the “Enable”, Automatic mode is enabled, an Automatic operation Parameter window (fig.4.16) appears. And the Auto. operation will be influenced by the follow two parameters “switching delay” and “minimum time”.

Note: The auto. operation function is only effected when the HVAC control is enabled. Please refer to the details instruction at chapter 4.6.4.

Parameter “Time mode for function ON”

The function time at fan ON is defined with this parameter. Options:

None

Switch delay

Minimum time

None: the fan ON is executed immediately .

Switch delay: the fan is switched on using this delay. The delay time can be set by the parameter “Delay time *0.1s [1...65535]”. If the object “Fan speed” received more than telegram “1” in a row, the delay time is counted from the first telegram “1” , instead of the last one.

Note: The operation ON after reset is also effected by this delay time. That is to say when the delay time is over, then the fan activated.

Minimum time: the fan remains ON for at least this time. The minimum time for ON can be set by the parameter “Minimum time *0.1s [1...65535]”. If the telegram of OFF the Fan during the period of this minimum time, the OFF operation is only executed after.

—Parameter “Delay time *0.1s [1...65535]”

The fan is switched on using this delay. Option: 1...65535

—Parameter “Minimum time *1s [1...65535]”

The fan remains ON for at least this time. Option: 1...65535

Parameter “Time mode for function OFF”

The function time at fan OFF is defined with this parameter. Options:

None

Switching delay

Minimum time

None: the fan OFF is executed immediately.

Switch delay: the fan is switched off using this delay. The delay time can be set by the parameter “Delay time *0.1s [1...65535]”

Minimum time: the fan remains OFF for at least this time. The minimum time for OFF can be set by the parameter “Minimum time *0.1s [1...65535]”. If the telegram of ON the Fan during the period of this minimum time, the ON operation is only executed after.

Note: The operation OFF after reset is also effected by this minimum time.

—Parameter “Delay time [1...65535] *0.1s”

The fan is switched off using this delay. Option: 1...65535

—Parameter “Minimum time [1...65535]s ”

The fan remains OFF for at least this time. Option: 1...65535

4.5.1.1 Parameter window “Auto. operation”

This Parameter window is visible if in the fig.4.15 the option “Enable” has been selected in the parameter “Auto. Operation function”. Fig.4.16 window is used to set auto. operation of one level fan, the threshold values for switchover of the fan ON/OFF is defined.

If the coil controller is from the local, the fan operation status can be changed automatic based on the control value or the threshold values range. The control value is defined by the PI algorithm of the internal program, which will not be sent to the bus. If the coil controller is from the bus, the fan speed is determined by the control value from the bus. Furthermore, the 4 limitations can also be enabled.

The direct operation and automatic operation cannot occur at the same time. That is, in the case that “Automatic function” has been activated, if there is direct operation, the Auto. Operation will be exited automatically, and it can be activated again by the object “Automatic function”. The object “Status Automatic” will report whether the status of automatic operation is activated or not.

General	Auto.operation on object value	<input type="radio"/> 0=Auto/1=Cancel <input checked="" type="radio"/> 1=Auto/0=Cancel
Interface Setting	State of Auto.operation after startup	<input checked="" type="radio"/> Disable auto.operation <input type="radio"/> Enable auto.operation
HVAC-General	Automatically enable auto.operation	<input type="radio"/> No <input checked="" type="radio"/> Yes
Temperature	Enable auto.operation after [10..6000]min	100
Setpoint	Threshold value OFF <-> ON [1..255] (For 2 point, it's Tem.difference*0.1°C)	100
Heating valve (Relay)	Hysteresis value is threshold value in +/- [0..50] (For 2 point, it is unused)	10
Cooling valve (Relay)	Limitation function	<input type="radio"/> Disable <input checked="" type="radio"/> Enable
Fan	Fan with limitation 1	Disable
	Fan with limitation 2	Disable
	Fan with limitation 3	Disable
	Fan with limitation 4	Disable
Auto. operation		
Fan status		

Fig.4.16 Parameter window “Auto. operation”

Parameter "Auto. Operation on object value"

This parameter is used to activate the telegram value of auto.operation.Options:

0=Auto/1=Cancel

1=Auto/0=Cancel

0=Auto/1=Cancel: When the object "Automatic function"receives the telegram value "0",the auto. Operation is activated;when telegram value "1",the auto. Operation is canceled.

1=Auto/0=Cancel: When the object "Automatic function"receives the telegram value "1",the auto. Operation is activated;when telegram value "0",the auto. Operation is canceled.

Parameter "State of Auto. operation after startup"

This parameter is used to Enable/Disable the auto.Operation when the devices is started up.Options:

Disable auto. operation

Enable auto. operation

Disable auto. Operation: After startup,the default auto.Operation is disable.

Enable auto. Operation: After startup,the default auto.Operation is enable.

Parameter "Automatically enable auto. operation"

This parameter is used to set if the automatically enable function of the auto.Operation is enabled or not.Options:

No

Yes

Yes: When enabled,the following parameter is visible.If there is no operation after the time,which is set in the following parameter,it will automatically enable the auto.Operation.

Parameter "Enable auto. Operation after [10..6000]min"

This parameter is used to set the time from the direct operation to auto.operation.

Parameter "Threshold value OFF<->ON [1...255](For 2 point, it's Tem. difference*0.1°C)"

Here the threshold value, at which switch on occurs, is defined. The control value is determined by the object "Control value".Options:1...255

If the control value is greater than or equal to the parameterized threshold value, the fan is switched on.

If the value is less, the fan is switched off.

Note: If the controller is from the local under the 2-point control,it will automatically ON/OFF the fan based on the temperature difference between the actual temp.and set temp.Thus this parameter is used to set the temperature difference 1..255 (*0.1°C)

Under PI control, the control value is defined by the PI algorithm of the internal program, which will not be sent to the bus. The controller will determine the fan ON/OFF based on where the control value is located in threshold value range.

Parameter "Hysteresis value is threshold value in +/- [0...50] (For 2 point, it is unused)"

Here a hysteresis value is set, at which switchover to the fan switch occurs. Using hysteresis, a continuous switching of the fan around the threshold value with the control value deviating can be avoided. Options: 0...50.

The setting 0 causes immediate switching without hysteresis.

Assuming the hysteresis value is 10 and the threshold value is 50, then the upper threshold value will be 60 (the threshold value + the hysteresis value), the lower threshold value will be 40 (the threshold value - the hysteresis value), then when the control value is between 40 and 60, it will not cause the operation of the fan. Only less than 40 is off the fan, and greater than 60 is on the fan. As shown below:

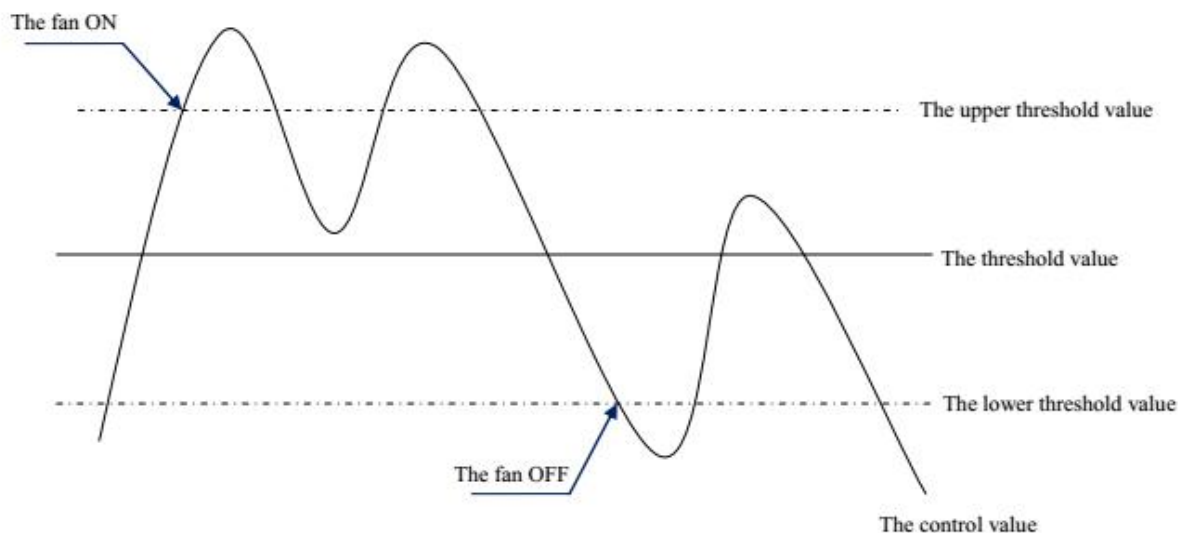

Parameter "Limitation function"

The parameter set the fan speed limitation under the Auto. Operation. Options:

No

Yes

Yes: the following parameters is visible. And 4 communication objects "Fan Limitation x (x=1,2,3,4)" for limitation of the fan switching are enabled.

The four limitations can be used for example for the control of various operation modes such as:

Limitation 1: e.g. for frost/heat protection

Limitation 2: e.g. for comfort operation

Limitation 3: e.g. for night shutdown

Limitation 4: e.g. for standby operation

In normal cases, the thermostat takes these operating modes into account in its control variable for the room

controller.

The sequence of the displayed parameters corresponds with their priorities, i.e. the parameter with the highest priority has limitation 1 followed by limitation 2, 3 and 4. So the highest priority is assigned to limitation 1, e.g. Frost/Heat protection; the lowest priority is assigned to limitation 4, e.g. standby operation.

The limitation is activated if a telegram with the value 1 is received on the limitation object. The limitation is deactivated if a telegram with the value 0 is received on the limitation object.

The direct operation and the forced operation can end the Auto. Operation, but the limitations status can be maintained, it will affect the Auto. Operation again when the Auto. Operation is activated again. And even if the limitations can be also activated during the forced operation, but they only affect the Auto. Operation.

If a limitation is activated during the Auto. Operation, the switching of the fan is switchover to the parameterized status regardless of the control value. For example, a limit is set to "ON", the fan is only switched on when the limit is activated. If there are several limitations, their priorities need to be considered.

After the limitations are cancelled or the Auto. Operation is re-activated, the fan switching and the control value are recalculated and executed. This means that the fan switching will be executed according to the latest control value.

After programming or bus voltage recovery, if the control value has been not received before the Auto. Operation active and the limitations are not activated, now the output is no action.

Parameter "Fan with limitation x (x=1,2,3,4)"

With this parameter, the fan switching can be set in active limitation. There are the same parameters for each of the individual four limitations. Options:

Disable

Unchange

OFF

ON

Disable: The limitation is not effect to the Auto. Operation, but the status can be activated.

Unchange: The fan status is remained the current status when the limitation is activated.

OFF: The fan is only switched off when the limitation is activated.

ON: The fan is only switched on when the limitation is activated.

4.5.1.2 Parameter window“Fan status”

The Parameter window “Fan Status”is shown in fig.4.17.,Here the status messages are defined for the Fan-one level.

General	Reply mode of Obj. "status ON/OFF mode" 1bit function	Respond after change
Interface Setting	Reply mode of Obj. "status Auto. mode" 1bit function	Respond after change
Fan		
Auto. operation		

Fan status

Fig 4.17 Parameter window“Fan status”

Parameter“Reply mode of Obj. “Status Fan ON/OFF mode” 1bit function”

This parameter is used to set the feedback way of fan working status.Options:

Respond after read only

Respond after change

Respond always

Respond, after read only: Only when the devices receives a read request of the working status from other devices or the bus,the object “Status Fan ON/OFF”will send the current working status to the bus.

Respond after change: The object“Status Fan ON/OFF”status send the status after a change or a read request.

Respond always:No matter the fan status is after read or after change,the object “Status Fan ON/OFF”is always send the current status to the bus.

Parameter“Relay mode of Obj. “Status Automatic”1 bit function”

This parameter is visible when auto operation enabled and used to define the feedback way of auto.Operation status.

When the parameter“Status Automatic”send telegram value 1,the auto.Operation is activated;send 0,the auto.Operation is disabled.Options:

Respond after read only

Respond after change

Respond always

Respond after read only: Only when the devices receives a read request of the working status from other devices or the bus,the object “Status Automatic”will send the current working status to the bus under the auto.Operation.

Respond after change: The object“Status Fan ON/OFF”status send the status after a change or a read request under auto.operation.

Respond always: No matter the fan status is after read or after change, the object "Status Fan ON/OFF" is always send the current status to the bus under auto.operation.

4.5.2 Parameter window "Fan type -- Multi-level"

The Parameter window of multi-level fan speeds is shown in fig.4.18. The parameters is shown as follows:

General	Fan type	<input type="radio"/> One level <input checked="" type="radio"/> Multi-level
Interface Setting	Fan speeds on 2 limit	<input checked="" type="radio"/> No <input type="radio"/> Yes
HVAC-General	Fan operation mode	<input checked="" type="radio"/> Changeover switch <input type="radio"/> Step switch
Temperature	Delay between fan speed switch*ms [50...5000]	500
Setpoint	When bus failure, Fan speed is	Unchange
Heating valve (Relay)	When bus recovery, fan speed is	Unchange
Cooling valve (Relay)	After downloading, fan speed is	OFF
	Threshold value for Fan speed 1[1...255]	50
	Threshold value for Fan speed 2[1...255]	150
	Threshold value for Fan speed 3[1...255]	255
Fan	"Forced operation" function	<input checked="" type="radio"/> Disable <input type="radio"/> Enable
Fan status	Auto. operation function (only for HVAC)	<input checked="" type="radio"/> Disable <input type="radio"/> Enable
Scene	Direct operation function	<input type="radio"/> Disable <input checked="" type="radio"/> Enable
Version	Obj. "Switch speed x " 1bit function	<input type="radio"/> Disable <input checked="" type="radio"/> Enable
	Obj. "Fan speed Up/Down" 1bit function	<input type="radio"/> Disable <input checked="" type="radio"/> Enable
	Delay time for function OFF *0.1s [0...65535]	0
	Starting characteristic of fan	<input type="radio"/> Disable <input checked="" type="radio"/> Enable
	Switch on over fan speed	2
	Minimum time in switch*s[1...65535]	10

Fig. 4.18 parameter window "Fan-two/three level"

The two level fan speeds and the three level fan speeds have the same parameter settings. Just the fan speeds are limited to two, the fan speed 3 is also 2.

Some technical characteristics need to be considered with a multi level speed fan, such as fan operation mode, starting characteristic, changeover switch or step switch etc. Only know these characteristics, you can set the following parameters reasonably.

Parameter "Fan speeds on 2 limit"

With the parameter, the fan speeds can be limited to two. Options:

No

Yes

No: Can control the 3 level speed fan.

Yes: Can control the 2 level speed fan. A two speed fan is controlled via fan speeds 1 and 2, the objects of fan speed 3 is non-functional.

Note: When the fan speed is limited to 2 level, even the fan speed is set to 3 level after power recovery or reset, it will not be executed. It will keep the current status.

Parameter "Fan operation mode"

The control of the fan is set with this parameter. The mode of fan control should be taken from the technical data of the fan. Options:

Changeover switch

Step switch

Changeover switch: Only the corresponding output of the assigned fan speed is switched on with the parameterization. The delay time between the speed switchover and a minimum dwell time in a valve speed are programmable. The minimum dwell time in a fan speed is only active in automatic mode. With the changeover switch, the fan speed is directly switched on, as follows:

Output Fan speed	Output A	Output B	Output C
Off	0	0	0
Fan speed 1	1	0	0
Fan speed 2	0	1	0
Fan speed 3	0	0	1

Step switch: The individual fan speeds are activated consecutively (outputs switched on) until the required fan speed is achieved. The minimum dwell time in a fan speed is also only active in automatic mode. A step switch normally means that the previous fan speeds are usually switched on consecutively:

Output Fan speed	Output A	Output B	Output C
Off	0	0	0
Fan speed 1	1	0	0
Fan speed 2	1	1	0
Fan speed 3	1	1	1

For example, when it is speed 3, all three output work (CH A.B.C); When speed 2, two output work (CH A.B)

Note: This parameter is not visible under 0-10V control interface, and need be considered in conjunction with the technical characteristics of the fan.

Parameter "Delay between fan speed switch [50...5000]ms"

The parameter is visible if the fan operation mode selects "changeover switch", which is used to set a

switchover delay. This time is a fan specific factor and it is always taken into consideration. Options: 50...5000

After a target fan speed telegram is received, the target fan speed is carried out as soon as the delay has passed. However, switch the fan on do not need delay, switch the fan off need delay.

If a new fan speed is received during the delay, delay is not restarted and the new fan speed is carried out in the last.

Parameter "When power failure, Fan speed is"

The parameter defines the behavior of the fan on power voltage failure. Options:

Unchange

OFF

1

2

3

Note: If the fan speed is limited to 2 levels, but the parameter is with 3, then the fan speed will be unchanged after bus voltage failure.

When under 0-10V control mode, the output is 0V when power failure.

Parameter "When power recovery, fan speed is"

The behavior of the fan on power voltage recovery is defined here. Options:

Unchange

OFF

1

2

3

As before as bus fail

OFF: the fan is switched off.

1, 2 or 3: the fan switches to fan speed 1, 2 or 3.

As before as bus fail: The speed is the same with the speed before the power fails.

Note:

It is advisable to apply a power voltage before connecting the fan in order to achieve a defined switch state of the fan. This eliminates the possibility of the destruction of the fan due to an incorrect contact setting.

If the fan speed is limited to 2 levels, but the parameter is with 3, then the fan speed will be unchanged after bus voltage recovery.

Parameter "After downloading, fan speed is"

It is used to switch off the fan after program downloaded.

Parameter "Threshold value for Fan speed 1(1-255)"

The parameter is used to set a threshold value for switching to fan speed 1. If value of fan speed is no less than the value, then fan will run at speed 1, otherwise fan will be cut off. Option: 1-255

Parameter “Threshold value for Fan speed 2(1-255)”

The parameter is used to set a threshold value for switching to fan speed 2. If value of fan speed is no less than the value, then fan will run at speed 2. Option: 1-255

Parameter “Threshold value for Fan speed 3(1-255)”

The parameter is used to set a threshold value for switching to fan speed 3. If value of fan speed is no less than the value, then fan will run at speed 3. Option: 1-255

Parameter “Force operation” function

This parameter is used to enable the force operation. Options:

Disable

Enable

Disable: No limitation, every fan speed can run, including off the fan.

Enable: A 1bit communication object “Fan Forced Operation” is enabled. The following two parameters appear at the same time:

Parameter “Forced operation on object value is”

This parameter is used to set the telegram value of the activating the force operation. Options:

0=Force/1=Cancel

1=Force/0=Cancel

0=Force/1=Cancel: The Forced operation is activated by a telegram value 0 of the object “Forced Operation” and is cancelled by value 1.

1=Force/0=Cancel: the Forced operation is activated by a telegram value 1 of the object “Forced Operation” and is cancelled by value 0.

Note:

During the force operation, it is ignored of the automatic operation of the limit setting. After cancel compulsory operation, it will be updated of the automatic operation.

The forced operation is activating, but the fan speed under automatic operation still need to consider the minimum operation time, except the start-up fan speed, because it has its own minimum running time.

After a bus reset or programming, the forced operation is inactive by default.

Parameter “Limitation on forced operation”

This parameter defines forced under operation, the speed of the fan can run. Optional:

Unchange

1

1, off

2

2, 1**2, 1, off****3****3, 2****3, 2, 1****Off**

Unchanged: Fan speed remains the same, to maintain the current running status;

1: can only run fan speed 1 ;

1, off: can only run fan speed 1 and turn off the fan;

2: can only run fan speed 2;

2, 1: can only run fan speed 1 and 2;

2, 1, off: can only run fan speed 1, 2, and turn off the fan;

3: can only run fan speed 3;

3, 2: can only run fan speed 3 and 2;

3, 2, 1: can only run fan speed 1, 2, and 3 ;

Off: only turn off the fan;

Note:

In the case of the forced operation activation, if the current fan speed is not in the allowed range, the fan speed will switch to the fan speed near the current fan speed, running in the allowed range, such as the current fan speed is 1, allows the fan speed is 2, 3, so when activation the force operation, the fan speed will automatically switch to 2, if it is manually to the fan speed is set to 1, run the fan speed will also be 2.

Another case, if the current fan speed is off, allowing the fan speed is 1, 2, 3, start fan speed is 3, when the force operation activation, fan to start with the fan speed 3, then automatically switch to the fan speed 1. If the current fan speed is 2, allowing the fan speed is 1, 2, when the force operation activation, receive a message with a fan speed off, then the fan speed will switch to 1, this kind of circumstance is the fan speed will switch to the near target fan speed .

Parameter "Auto. Operation function (only for HVAC)"

This parameter is used to enable automatic operation of the fan. Optional::

Disable

Enable

Enable: parameter interface 4.19 will be visible.

Note: Automation operation is available only when HVAC controls enable. Detailed description refer to section 4.6.4.

Parameter "Direct operation function"

This parameter can make the fan control operation directly. Direct operating mainly in a different way to manually adjust the fan speed.

Different types of fans, such as switch type of blower fan and stepping switch mode, suitable for different control mode, according to actual needs. Optional:

Disable

Enable

Enable: the following two parameters can be seen, each parameter corresponding to a kind of control mode, three levels of fan speeds can be separately controlled by 3 1bit objects. also can through an 1bit object step by step raised or lowered, or through an 1byte object directly open the specified fan speed.

Note:

During the period of direct operation, it is ignored of the setting of the minimum residence time of the automatic mode. Therefore, timely detection of direct manipulation response.

In order to protect the fan, the fan speed switch delay time are still valid. The forced operation is activated at the same time, need to take into account the force can run under fan speed.

Parameter "Obj. 'Fan speed x' 1bit function"

Options:

Disable

Enable

Enable: Three 1 bit of object "Fan speed 1", "Fan speed 2" and "Fan speed 3" will be visible.

When object received "1", open the corresponding fan speed, three objects of any object received "0", the fan off.

If three objects in a short time continuous received ON/OFF, so the message is received by the final object value to control fan speed.

Parameter "Obj. 'Fan speed Up/Down' 1bit function"

Optional:

Disable

Enable

Enable : 1 bit of object "Fan speed UP/DOWN" visible, object received "1" increase fan speed , while received "0" decrease fan speed .

When fan speed reaches maximum (speed 3) or minimum (off), continue to increase or decrease, the fan speed will remain, the continue to increase or reduce the message will be ignored and does not perform, and the fan speed is to increase or decrease step by step.

If multiple upward or downward adjustment fan speed in a short time, the target speed will increase a continuous multistage or reduce stage, such as the current fan speed is 1, received two consecutive increase message, then will execute the fan speed 3.

Parameter "Delay time for function OFF [0..65535]*0.1s"

This parameter is used to define the delay off time.

For example, when the current fan speed is speed 1 and a fan OFF telegram is received, the fan will keep the current speed and start to counting the delay time. After this delay time, the fan off action will be executed.

Note:

Under the auto.operation mode, this parameter is executed when the parameter "Minimum time in fan speed [0...65535]s" is set to 0.

Parameter "Starting characteristic of fan"

This parameter to define the fan characteristics of start, this is also a technical characteristics of the fan.

Generally, in order to guarantee the safety of the fan motor start, when the fan open, to open a higher fan speed fan motor will be better, so that the fan motor to obtain a higher torque when startup.

Fan used in our life, such as floor fan, when open the fan, usually started from the second fan speed, and then switch to the minimum fan speed, some fans start also like this kind of situation. Options:

Disable

Enable

Enable: the following two parameters visible.

Note:

Due to it is a technical characteristics of startup feature of the fan, so start behavior has a higher priority than activate the automatic operation under the restriction or forced operation.

If the fan has No start features, we don't have to consider the characteristics of relevant parameters, it can be as long as selecting "No".

For example, Start fan speed is 3, limit allowed by the operation of the fan speed is 2, the current in the OFF state, when receiving a control message in the fan speed is 1, the fan will open with fan speed 3, and then turn to fan speed 2, then the actual need of fan speed 1 will not run due to the limit. (to be automatic operation under the restrictions described in the next chapters 4.5.2.1)

For stepping switch type of fan, the feature of start is not the same, stepping switch type of fan is usually continuous open fan speed, and switch to switch type of fan is directly open the fan speed. So in defining characteristic parameters of start, also need to consider the fan switch type.

Switching fan speed in the Automatic mode, the minimum residence time will be considered after startup phase, in the start-up phase it is not activated. Start-up fan speed on the minimum residence time can be set up in addition, refer to the following parameters.

—Parameter "Switch on over fan speed"

This parameter is set the needed speed to start the fan from the OFF state. Optional: 1/2/3

When in the fan speed 2, if start fan speed set 3, then start up automatically with speed 2 to start.

But in order to ensure the normal operation of the fan, it can set the parameters associated with fan performance, it's best to know the characteristics of the fan, reasonable according to the characteristics of the fan to set these parameters, so that no damage to the fan.

—Parameter "Minimum dwell period in switch[1..65535]*s"

1...65535 This parameter defined in the start stage to open a certain fan speed, the minimum residence time.

Optional: 1... 65535

When the fan star up, will start up with the star up fan speed , switch to the target fan speed after the minimum residence time , the target speed can be the fan speed of the reset fan, or triggered by other operating speed.

Start-up phase, delay time of switch between two fan speed is also need to be taken into account.

For example: a start-up behavior with 3 levels fan speed of the fan

Assuming that the fan current state is closed, the fan speed is level 3, target speed is level 1, eventually fan speed is level 2, as shown in the figure below:

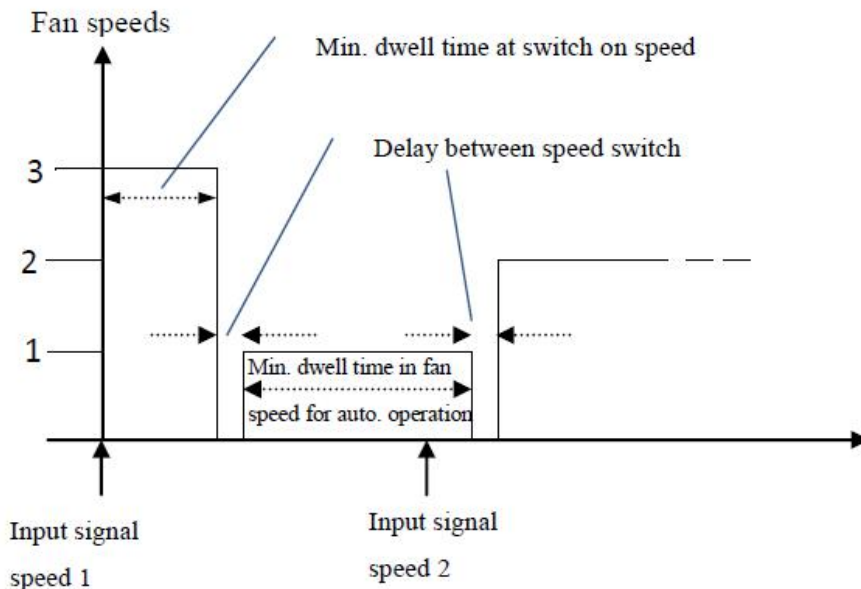

Shown above, if the fan is in a off state, when it received a "fan speed 1" message, it will star up with "wind 3" , after the minimum residence time of start-up fan speed, and then switch fan speed, switch of fan speed needs a delay time (this is a technical parameters of the fan, good to protect the fan), after the delay, and switch to the target speed "fan speed 1", in the process of the operation of the "fan speed 1", if the fan receives a message of "fan speed 2" , at this time need to consider whether the automatic mode is activated, if the automatic mode is active, you will need to consider the minimum residence time of fan speed run , if it is a direct operation, do not need to consider the minimum residence time of fan speed run , after the switching delay, and running to "fan speed 2".

4.5.2.1 Parameter window “Fan: Auto. operation”

This parameter window (Fig.4.19) is visible if in Fig. 4.18 the option Enable has been selected in the parameter “Auto. Operation function”.

Here set the auto. Operation of multilevel fan, the threshold values for switch over of the fan ON/OFF is

defined.

If the coil controller is from the local, the fan will automatically ON/OFF the fan based on the control value or temperature difference in the threshold value range. The control value is defined by the PI algorithm of the device internal program, which will not be sent to the bus.

If the coil controller is from the bus, the speed is determined by the control value of the bus.

Furthermore, there are 4 limitations can be set.

General	Auto.operation on object value	<input type="radio"/> 0=Auto/1=Cancel <input checked="" type="radio"/> 1=Auto/0=Cancel
Interface Setting	State of Auto.operation after startup	<input checked="" type="radio"/> Disable auto.operation <input type="radio"/> Enable auto.operation
HVAC-General	Automatically enable auto.operation	<input type="radio"/> No <input checked="" type="radio"/> Yes
Temperature	Enable auto.operation after [10..6000]min	100
Setpoint	Threshold value OFF<-->speed 1[1..255] (For 2 point, it's Tem.difference*0.1°C)	80
Heating valve (Relay)	Threshold value speed 1<-->speed 2 [1..255](For 2 point, it's Tem.difference*0.1°C)	150
Cooling valve (Relay)	Threshold value speed 2<-->speed 3 [1..255](For 2 point, it's Tem.difference*0.1°C)	200
Fan	Hysteresis value is threshold value in +/- [0..50](For 2 point, it is unused)	10
Auto.operation	Minimum time in fan speed[0..65535]*s	10
Fan status	Limitation function	<input type="radio"/> Disable <input checked="" type="radio"/> Enable
Scene	Fan with limitation 1	Unchange
Version	Fan with limitation 2	1,OFF
	Fan with limitation 3	2,1
	Fan with limitation 4	3,2,1

Fig. 4.19 Parameter window "Fan: Auto. operation"

Parameter "Auto. operation on object value"

This parameter defines how to react to a telegram value of activating the auto.Operation. Options:

0=Auto/1=Cancel

1=Auto/0=Cancel

0=Auto/1=Cancel: Automatic is activated by a telegram with value 0 and inactive by value 1.

1=Auto/0=Cancel: Automatic is activated by a telegram with value 1 and inactive by value 0.

Parameter "State of Auto. operation after startup"

This parameter is used to Enable/Disable the auto.Operation when the devices is started up. Options:

Disable auto. operation

Enable auto. operation

Disable auto. Operation: After startup, the default auto.Operation is disable.

Enable auto. Operation: After startup, the default auto. Operation is enable.

Parameter "Automatically enable auto. operation"

This parameter is used to set if the automatically enable function of the auto. Operation is enabled or not. Options:

No

Yes

Yes: When enabled, the following parameter is visible. If there is no operation after the time, which is set in the following parameter, it will automatically enable the auto. Operation.

Parameter "Enable auto. Operation after [10..6000]min"

This parameter is used to set the time from the direct operation to auto. operation. Options: 10..6000

Parameter "Threshold value OFF<->speed 1 [1...255] (For 2 point, it's Tem. difference*0.1°C)"

Here to defined the threshold value that switch between fan off and fan speed 1. Options: 1...255

If the control values greater than or equal to the threshold of the parameter Settings, run speed 1, else off the fan

Note:

If the controller is from the local under the 2-point control, it will automatically ON/OFF the fan based on the temperature difference between the actual temp. and set temp. Thus this parameter is used to set the temperature difference 1..255 (*0.1°C) .

Under PI control, the control value is defined by the PI algorithm of the internal program, which will not be sent to the bus. The controller will determine the fan ON/OFF based on where the control value is located in threshold value range.

The following 2 parameter is similar to this one.

Parameter "Threshold value speed 1<->speed 2 [1...255] (For 2 point, it's Tem. difference*0.1°C)"

Here to defined the threshold value when switch to speed 2, if the control values greater than or equal to the threshold of the parameter Settings, run speed 2;

Options: 1...255

Parameter "Threshold value speed 2<->speed 3 [1...255] (For 2 point, it's Tem. difference*0.1°C)"

Here to defined the threshold value when switch to speed 3, if the control values greater than or equal to the threshold of the parameter Settings, run speed 3.

Options: 1...255

Note:

The controller in the form of an ascending to evaluate these thresholds, that is, first of all check OFF <-> threshold of fan speed 1, and then the fan speed 1 <-> fan speed 2, fan speed 2 <-> fan speed 3. The correctness of the functions performed in such a case only guaranteed: the threshold value of OFF <-> fan

speed 1 is less than the threshold value of fan speed 1 < - > fan speed 2, the threshold value of fan speed 1 < - > fan speed 2 is less than the threshold value of fan speed 2 < - > fan speed 3.

Parameter "Hysteresis value is threshold value in +/- [0...50](For 2 point, it is unused)"

Here a hysteresis value is set, at which switch over to the fan switch occurs. Using hysteresis, a continuous switching of the fan around the threshold value with the control value deviating can be avoided. Options: 0...50

The setting 0 causes immediate switching without hysteresis.

Assuming the hysteresis value of 10 and the threshold value is 50, then the upper threshold value will be 60 (the threshold value + the hysteresis value), the lower threshold value will be 40 (the threshold value - the hysteresis value), then when the control value is between 40 and 60, it will not cause the operation of the fan, only less than 40 is off the fan, and greater than 60 is on the fan. As shown below:

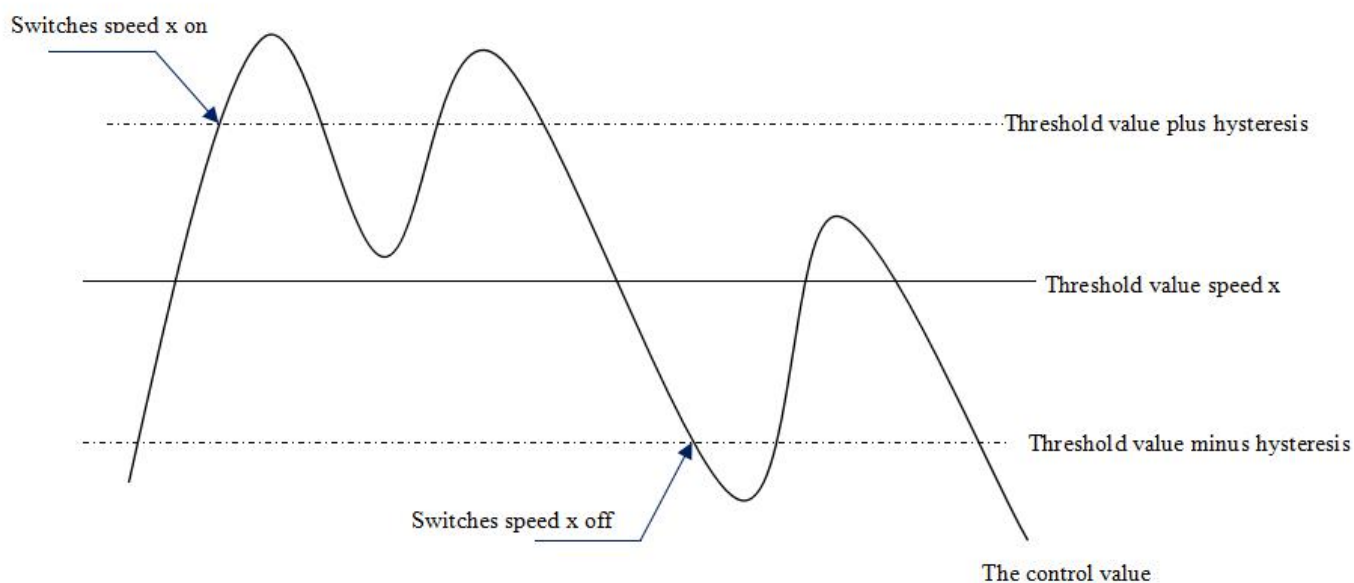

Note:

In enabling the lagging situation, if there is a threshold overlap, fan action rules are as follows:

1)the hysteresis determine the fan speed conversion of control points;

2)if the fan speed transformation, the new fan speed is determined by the control values and threshold, without considering lag;

For example, (1) :

OFF < - > fan speed 1 threshold of 10%

Fan speed 1 < - > fan speed 2 threshold of 20%

Fan speed 2 < - > fan speed 3 threshold of 30%

Hysteresis is 15%

The fan speed behavior of fan raise from OFF :

OFF state of the fan will be in the control values of 25% ($\geq 10\% + 15\%$) this point to shift , the new fan speed will be 2 (because of 25% between 20% to 30% , no need to consider lag at this time), so the fan speed 1 is ignored;

The behavior of the fan's fan speed decreased from 3:

Fan speed 3 will be in control values 14% (< 30% 15%) this point to shift, a new fan speed will be 1 (because of 14% between 10% to 20% , no need to consider lag), so the fan speed 2 is ignored.

For example, (2) :

OFF < - > fan speed 1 threshold of 10%

Fan speed 1 < - > fan speed 2 threshold of 40%

Fan speed 2 < - > fan speed 3 threshold of 70%

Hysteresis is 5%

The fan speed behavior of fan raise from OFF :

OFF state of the fan will be in the control values of 15% ($\geq 10\% + 5\%$) this point to shift . If received the control value is 41%, the new fan speed will be 2 (because of 41% between 40% to 70% , no need to consider lag at this time), so the fan speed 1 is ignored; if received the control value is 39%, the new fan speed is 1 (because of 39% between 10% to 40% , no need to consider lag at this time)

The behavior of the fan's fan speed decreased from 3:

Fan speed 3 will be in control values 64% (<70%-5%) this point to shift.

If received the control value is 39%, the new fan speed will be 1 (because of 39% between 10% to 40% , no need to consider lag), so the fan speed 2 is ignored.

3)No matter what happens, control values is 0, the fan will turn off;

Parameter "Minimum time in fan speed [0... 65535] s"

This parameter to define the residence time before the current fan speed switch to a higher or lower fan speed , which is a minimum fan speed running time, if you want to switch to another fan speed, can only be to switch after waiting for this period of time, if the current fan speed has been running long enough, the fan speed change can quickly switch. Optional: 0... 65535

0: means not delay switch;

Note:

The setting of the residence time in this parameter is only using in automatic mode .

Automatic mode of each fan speed (including off) need to consider the minimum operation time, and automatic operation of the fan speed is changed step by step , such as the current fan speed is 1, the target speed is 3, then the fan speed transform from 1 to 2, and 3, and each operation of the fan speed over the minimum operation time to transform.

Start fan speed without considering the minimum run time, because the starting fan speed has its own minimum running time.

Parameter "Limitation function"

The parameter set the fan speed limitation under the Auto. Operation. Options:

Disable

Enable

Enable: The following parameters is visible. And 4 communication objects “Fan Limitation x (x=1,2,3,4)” for limitation of the fan switching are enabled.

The four limitations can be used for example for the control of various operation modes such as:

Limitation 1: e.g. for frost/heat protection

Limitation 2: e.g. for comfort operation

Limitation 3: e.g. for night shutdown

Limitation 4: e.g. for standby operation

In normal cases, the thermostat takes these operating modes into account in its control variable for the room controller.

The sequence of the displayed parameters corresponds with their priorities, i.e. the parameter with the highest priority has limitation 1 followed by limitation 2, 3 and 4. So the highest priority is assigned to limitation 1, e.g. Frost/Heat protection; the lowest priority is assigned to limitation 4, e.g. standby operation.

The limitation is activated if a telegram with the value 1 is received on the limitation object. The limitation is deactivated if a telegram with the value 0 is received on the limitation object.

The direct operation and the forced operation can end the Auto. Operation, but the limitations status can be maintained, it will affect the Auto. Operation again when the Auto. Operation is activated again. And even if the limitations can be also activated during the forced operation, but they only affect the Auto. Operation.

If a limitation is activated during the Auto. Operation, the switching of the fan is switchover to the parameterized status regardless of the control value. For example, a limit is set to “ON”, the fan is only switched on when the limit is activated. If there are several limitations, their priorities need to be considered.

After the limitations are canceled or the Auto. Operation is re-activated, the fan switching and the control value are recalculated and executed. This means that the fan switching will be executed according to the latest control value.

After programming or bus voltage recovery, if the control value has been not received before the Auto. Operation active and the limitations are not activated, now the output is no action.

—Parameter “Fan with limitation x (x=1,2,3,4)”

With this parameter, the fan switching can be set in active limitation. There are the same parameters for each of the individual four limitations. Options:

Disable

Unchange

1

1, off

2

2, 1

2, 1, off

3

3, 2

3, 2, 1

Off

“Disable”: No limitation, every fan speed can run, including off the fan.

“Unchanged”: Fan fan speed remains the same, to maintain the current running status;

“1”: can only run fan speed 1 ;

“1, off”: can only run fan speed 1 and turn off the fan;

“2”: can only run fan speed 2;

“2, 1”: can only run fan speed 1 and 2;

“2, 1, off”: can only run fan speed 1, 2, and turn off the fan; 只能运行风速 1, 2 和关风机;

“3”: can only run fan speed 3;

“3, 2”: can only run fan speed 3 and 2;

“3, 2, 1”: can only run fan speed 1, 2, and 3;

“off”: only turn off the fan.

4.5.2.2 Parameter window “Fan: status”

The parameter window “Fan: Status” is shown in fig.4.20. This interface is used to set multilevel fan speed of the fan's running status information.

General	Reply mode of Obj. "status ON/OFF mode" 1bit function	Respond after change
Interface Setting	Reply mode of Obj. "status Auto. mode" 1bit function	Respond after change
Fan	Reply mode of Obj. "Status fan speed x" 1bit function	Respond after change
Auto.operation	Reply mode of Obj. "Status fan speed" 1byte function	Respond after change
Fan status	Object value for Status Fan speed 1 [1...255]	84
Output C	Object value for Status Fan speed 2 [1...255]	168
Output D	Object value for Status Fan speed 3 [1...255]	255
Output E		
Version		

Fig.4.20 Parameter Window “Fan: status”

Parameter “Reply mode of Obj. “status ON/OFF mode” 1bit function”

This parameter is used to set the feedback way of fan working status. Options:

Respond after read only

Respond after change

Respond always

Respond, after read only: Only when the devices receives a read request of the on/off status from other

devices or the bus, the object "Status Fan ON/OFF" will send the current on/off status to the bus.

Respond after change: The object "Status Fan ON/OFF" status send the status after a change or a read request.

Respond always: No matter the fan status is after read or after change, the object "Status Fan ON/OFF" is always send the current status to the bus.

Parameter "Relay mode of Obj. "status Auto. mode" 1 bit function"

This parameter is visible when auto operation enabled and used to define the feedback way of auto.Operation status. When the object "Status Automatic" send telegram value 1, the auto.Operation is activated; send 0, the auto.Operation is disabled. Options:

Respond after read only

Respond after change

Respond always

Respond after read only: Only when the devices receives a read request of the working status from other devices or the bus, the object "Status Automatic" will send the current status of the auto.Operation to the bus .

Respond after change: The object "Status Automatic" send the status of auto.operation after a change or a read request .

Respond always: No matter the fan status is after read or after change, the object "Status Automatic" is always send the current status of auto.operation to the bus.

Parameter "Relay mode of Obj. "Status fan speed x" 1bit function"

The parameter is used to define the feedback way of the speed status. The following three 1 bit object "Status Fan speed 1", "Status Fan speed 2" and "Status Fan speed 3" are used to indicate the status of every level speed.

Respond after read only

Respond after change

Respond always

Respond after read only: Only when the devices receives a read request of the working status from other devices or the bus, the objects will send the current working status to the bus.

Respond after change: The objects send the status after a change or a read request.

Respond always: No matter the fan status is after read or after change, the objects are always send the current status to the bus.

Parameter "Relay mode of Obj. "Status fan speed" 1byte function"

This parameter is used to set the feedback way of current fan working status. The length is 1 byte. The fan speed output status value is defined by the following parameter ("Object value for Status Fan speed 1/2/3 [1..255]"). Options:

Respond after read only

Respond after change

Respond always

Respond, after read only: ; Only when the devices receives a read request of the working status from other devices or the bus,the object will send the current working status to the bus.

Respond after change: The object sends the status after a change or a read request.

Respond always: No matter the fan status is after read or after change,the object always sends the current status to the bus.

Parameter: "Object value for Status Fan speed 1/2/3 [1..255]"

This parameter is used to set the output value of fan speed status.That is to say it can define the output value of every fan speed.Options:1..255

The status of fan off is predefined as 0.

4.6 Valve Output

This chapter introduces HVAC system of the valve control unit, following the fan control of the previous section. The fan coil actuator can be used to control 2-pipe or 4-pipe system.

The fan and the HVAC system can be parameterized independently. Therefore, when we use the fan coil actuator to control the valve, we need to consider both the fan and HVAC system parameter settings and reasonably set them in order to the two parts to better work together.

The valve is the end product of central air-conditioning, thus the function of the room controller is mainly used in places with central air-conditioning, to give a room heating, cooling and ventilation.

Pipe systems description:

In daily life, a fan coil unit can be configured as a 4-, 3- or 2-pipe system.

The 2 pipe system consists of just a single water circuit, which is heated or cooled alternately to suit the season. In a 2 pipe fan coil unit, there is only one heat exchanger with a valve for heating or cooling, the control value for heating or cooling is provided by a thermostat, only warm or only cold water is supplied centrally to the pipe system.

In many HVAC systems, cooling is undertaken exclusively with a 2 pipe fan coil unit. The heating function is undertaken by a conventional heater or an electrical heater in the fan coil unit.

The 3 pipe system has a similar design to the 4 pipe system. It has a separate inlet for heating and cooling water as well as two separate heat exchangers with one valve each.In contrast to a 4 pipe system the 3 pipe

system has a common return flow for heating or cooling water.

Note: this device don not support 3-pipe system.

In a 4 pipe system, separate water circulation loops are used for heating and cooling water. Thus there are also two separate heat exchangers for heating and cooling which are each triggered via a single valve in the fan. Warm and cold water is provided centrally to two separate pipe system. That is to say the heating and cooling can not be used at the same time.

Connections of 4-pipe system: Connect the relevant valve of the pipe to the heating/cooling output of the device to control flow the warm and cool water.

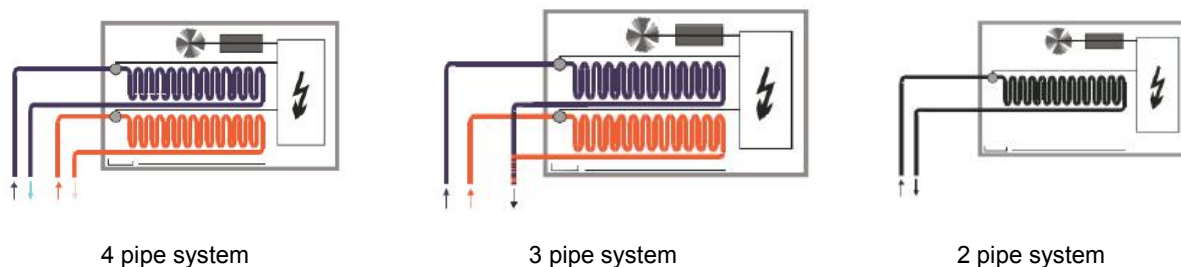

4.6.1 Parameter window “Heating/Cooling valve (Relay)”

The parameter setting interface of “Heating valve (Relay)” and “Cooling valve (Relay)” is shown in Figures 4.21 and 4.22. When the drive interface of the heating valve/cooling valve is controlled by relay, the following uses the parameters of the heating valve/cooling valve in detail.

General	Valve control mode	<input type="radio"/> 2 state-ON/OFF <input checked="" type="radio"/> Continuous,PWM
Interface Setting	Valve type	<input checked="" type="radio"/> Normal (de-energised closed) <input type="radio"/> Inverted (de-energised open)
HVAC-General	The Controller use PI control method	<--Attention
Temperature	PWM cycle time*s[60-3000]	120
Setpoint	When bus failure, valve position	Unchange
Heating valve (Relay)	Reply mode of Obj."status of valve position" 1bit function	<input type="radio"/> Respond after read only <input checked="" type="radio"/> Respond after change
Cooling valve (Relay)	Valve purge function	<input type="radio"/> Disable <input checked="" type="radio"/> Enable
Scene	Duration of valve purge time*min [1...255]	10
Output A	Automatic valve purge	<input type="radio"/> Disable <input checked="" type="radio"/> Enable
Output B	Purge Cycle in weeks[1...12]	1
Output C	Reply mode of Obj."status of valve purge" 1bit function	Respond after change
Version	"Disable heating" object function	<input type="radio"/> Disable <input checked="" type="radio"/> Enable
	Trigger object value	<input checked="" type="radio"/> 0=Disable/1=Enable <input type="radio"/> 1=Disable/0=Enable

Fig. 4.21 parameter window "Heating valve (Relay)"

General	Valve control mode	<input type="radio"/> 2 state-ON/OFF <input checked="" type="radio"/> Continuous,PWM
Interface Setting	Valve type	<input checked="" type="radio"/> Normal (de-energised closed) <input type="radio"/> Inverted (de-energised open)
HVAC-General	The Controller use PI control method	<--Attention
Temperature	PWM cycle time*s[60-3000]	120
Setpoint	When bus failure, valve position	Unchange
Heating valve (Relay)	Reply mode of Obj."status of valve position" 1bit function	<input type="radio"/> Respond after read only <input checked="" type="radio"/> Respond after change
Cooling valve (Relay)	Valve purge function	<input type="radio"/> Disable <input checked="" type="radio"/> Enable
Scene	Duration of valve purge time*min [1...255]	10
Output A	Automatic valve purge	<input type="radio"/> Disable <input checked="" type="radio"/> Enable
Output B	Purge Cycle in weeks[1...12]	1
Output C	Reply mode of Obj."status of valve purge" 1bit function	Respond after change
Version	"Disable cooling" object function	<input type="radio"/> Disable <input checked="" type="radio"/> Enable
	Trigger object value	<input checked="" type="radio"/> 0=Disable/1=Enable <input type="radio"/> 1=Disable/0=Enable

Fig. 4.22 Parameter window "Cooling valve (Relay)"

Parameter "Valve control mode"

This parameter is used to set the type of valve to be controlled. Optional:

2 state-ON/OFF

Continuous, PWM

2 state-ON/OFF: Two-point switch control mode;

Continuous, PWM: PWM continuous control mode.

Parameter "Valve type"

This parameter sets the direction of the valve switch. Optional:

Normal (de-energised closed)

Inverted (de-energised open)

Normal (de-energised closed): indicates a normally closed switch;

Inverted (de-energised open): indicates a normally open switch.

—Parameter "Controller use 2-point control method"

When the parameter type is "2 state-ON/OFF", the two-point control mode is used only when the controller is local.

—Parameter "Controller use PI control method"

This parameter indicates that when the valve type is "Continuous, PWM", the PI control mode is used only when the controller is local.

—Parameter "PWM cycle time [60...3000]*1s"

This parameter is visible when the valve type is "Continuous, PWM" and is used to set the time period for PWM control.

The larger the value of the parameter, the smaller the valve switching frequency. Conversely, the smaller the value, the more frequent the valve switch. Optional: 60...3000s

Parameter "When power failure, valve position"

This parameter sets the position of the valve after the voltage is de-energized. Optional:

Unchanged

Open

Close

Unchanged: After the voltage is de-energized, the valve state remains unchanged;

Open: Valve open;

Close: Valve close.

Parameter "Reply mode of Obj. "Status of valve position" 1bit function"

This parameter defines how the valve status responds. Optional:

Respond after read only

Respond after change

Respond after read only: The object "Status of valve position" sends the current status to the bus only when the device receives the status from another bus device or bus;

Respond after change: When the status changes or the device receives a request to read the status, the object "Status of valve position" immediately sends a message to the bus to report the current status;

For Continuous, PWM valves, different switches, status feedback information is as follows:

Valve switch type	Description
Normal (de-energised closed)	When the valve is in the open state, the object "Status of valve position" sends the message "0"; when there is current (relay closed), the message "1" is sent; When there is no voltage (0V), the object "Status of valve position" sends the message "0"; when there is voltage (10V), the message "1" is sent.
Inverted (de-energised open)	When the valve has a current (relay closed), the object "Status of valve position" sends a message "0"; when there is no current (relay opened), the message "1" is sent; When the valve is at voltage (0V~10V, excluding 10V), the object "Status of valve position" sends the message "1"; when there is voltage (10V), the message "0" is sent.

Parameter "Valve purge function"

Optional:

Disable

Enable

Enable: A 1-bit communication object "Trigger valve purge" is visible to trigger the valve cleaning operation while the following parameters are visible.

—Parameter "Duration of valve purge time[1...255]*min"

This parameter sets the duration of the valve cleaning. During this time, the valve is fully open. When this time passes, the state before cleaning is re-established. Available options: 1...255min

If the heating/cooling operation is prohibited during cleaning, the cleaning will continue.

—Parameter "Automatic valve purge"

Visible when the valve cleaning function is enabled. Optional:

Disable

Enable

Enable: Enable the automatic valve cleaning function, the following parameters are visible.

—Parameter "Purge Cycle in weeks[1...12]"

This parameter defines the period of automatic valve cleaning, in weeks, the time starts from the power-on of the device, and the cleaning operation is triggered after timing.

Once the cleaning is completed, the time is reset, whether it is done by automatic cleaning or by object-triggered cleaning, this time will be reset.

Optional: 1...12

Note: The manual priority is the highest, and the cleaning priority is the second highest. If the cleaning time is not reached, the cleaning process is manually interrupted. After the cleaning is finished, the manual exit will not continue the cleaning.

Parameter "Reply mode of Obj."status of valve purge" 1bit function"

This parameter is visible when the valve cleaning function is enabled and defines the feedback mode for the valve cleaning status. Optional:

Respond after read only

Respond after change

Always

Respond after read only: The object "Status of valve purge" sends the current status to the bus only when the device receives the status from another bus device or bus;

Respond after change: When the status changes or the device receives a request to read the status, the object "Status of valve purge" immediately sends a message to the bus to report the current status;

Respond always: Always respond, receive control commands, regardless of whether the status changes or not.

Parameter ““Disable heating” object function”

Parameter ““Disable cooling” object function”

Optional:

Disable

Enable

Enable : A 1-bit communication object "Disable, heating/cooling" is visible and can be used to disable heating/cooling operations while the following parameters are visible.

—Parameter“Trigger object value”

This parameter sets the value of the message used to disable the heating/cooling operation. Optional:

0=Disable/1=Enable

1=Disable/0=Enable

0=Disable/1=Enable : When the object "Disable, Heat/Cool" receives the message value "0", the heating/cooling operation is prohibited. Reactivate when receiving "1";

1=Disable/0=Enable : When the object "Disable, Heat/Cool" receives the message value "1", the heating/cooling operation is prohibited. Reactivate when "0" is received.

Note: When the operation is disabled, the valve position is immediately back to the off state. When enabled again, the current state is maintained until a new control value is received. During the disable period, the received message is invalid (except for purge, the purge operation can be performed during the disable).

4.6.2 Parameter window “Heating/Cooling valve (0-10V)”

The parameter setting interface of “Heating valve (0-10V)” and “Cooling valve (0-10V)” is shown in Figures 4.23 and 4.24.

When the drive interface of the heating valve/cooling valve is controlled by 0-10V, the following uses the

parameters of the heating valve/cooling valve in detail. The functions of some parameters are the same as those in section 4.6.1.

General	Valve control mode	<input type="radio"/> 2 state-10V/0V <input checked="" type="radio"/> Continuous control
Interface Setting	Valve type	<input checked="" type="radio"/> Normally opened <input type="radio"/> Normally closed
HVAC-General	The Controller use PI control method	<--Attention
Temperature	Valve adjustment	<input type="radio"/> Disable <input checked="" type="radio"/> Enable
Setpoint	Minimum controller output for closed valve[0-100]%	0
	Maximum controller output for fully opened valve[0...100]%	100
Heating valve (0-10V)		
Cooling valve (0-10V)	Lower limit of active valve opening range[0...100]%	0
Fan	Upper limit of active valve opening range[0...100]%	100
Fan status	Reply mode of Obj."status of valve position" 1bit function	Respond after change
Scene	Valve purge function	<input checked="" type="radio"/> Disable <input type="radio"/> Enable
Output C	"Disable heating" object function	<input checked="" type="radio"/> Disable <input type="radio"/> Enable

Fig. 4.23 Parameter window "Heating valve (0-10V)"

General	Valve control mode	<input type="radio"/> 2 state-10V/0V <input checked="" type="radio"/> Continuous control
Interface Setting	Valve type	<input checked="" type="radio"/> Normally opened <input type="radio"/> Normally closed
HVAC-General	The Controller use PI control method	<--Attention
Temperature	Valve adjustment	<input type="radio"/> Disable <input checked="" type="radio"/> Enable
Setpoint	Minimum controller output for closed valve[0-100]%	0
	Maximum controller output for fully opened valve[0...100]%	100
Heating valve (0-10V)	Lower limit of active valve opening range[0...100]%	0
Cooling valve (0-10V)	Upper limit of active valve opening range[0...100]%	100
Fan	Reply mode of Obj."status of valve position" 1bit function	Respond after change
Fan status	Valve purge function	<input checked="" type="radio"/> Disable <input type="radio"/> Enable
Scene	"Disable cooling" object function	<input checked="" type="radio"/> Disable <input type="radio"/> Enable
Output C		

Fig. 4.24 parameter window "Cooling valve (0-10V)"

Parameter "Valve adjustment"

This parameter sets whether the characteristic curve adjustment of the valve is enabled. Optional:

Enable

Disable

Parameter "Min. controller output for closed valve[0-100]%"

—Parameter“Max. controller output for fully opened valve[0...100]%

—Parameter“Lower limit of active valve opening range[0...100]%

—Parameter“Upper limit of active valve opening range[0...100]%

The above parameters are only visible when "Enable" is selected in the parameter "Valve adjustment" and are used to set the characteristic curve of the valve output.

Optional: 0...100 [%]

Min. controller output for closed valve: The lower limit control value of the valve characteristic curve;

Max. controller output for fully opened valve: The upper limit control value of the valve characteristic curve;

Lower limit for active valve opening range: The lower limit of the valve limit value;

Upper limit for active valve opening range: The upper limit of the valve is limited.

Take the valve with the valve interface as the relay as an example. Assume that the lower limit of the control value is set to 10%, the lower limit of the valve is set to 20%, and the upper limit of the control value is set to 70%. When the upper limit of the valve is set to 80%, there is an output characteristic curve as shown below:

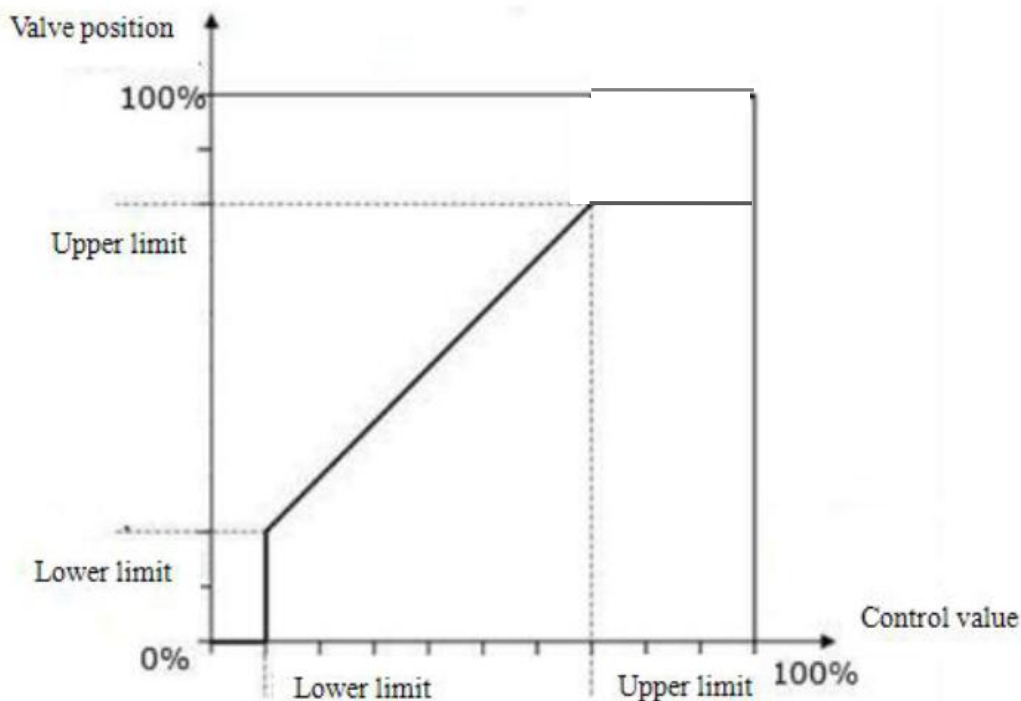

4.6.3 Parameter window “Scene”

The “Scene” parameter setting interface is shown in Figures 4.25, and it is visible when the HVAC output is enabled. Mainly set the scene of HVAC control, you can set 8 scenes.

Note: If the fan control is not enabled, the fan speed setting in the scene is meaningless.

General	Scene function	<input type="radio"/> Disable <input checked="" type="radio"/> Enable
Interface Setting	1>Assignment scene number(1-64 is active,0 is no assignment)	0
HVAC-General	HVAC Mode	Standby mode
Temperature	Fan Speed(if fan type is one level,all 1/2/3 mean on)	Unchange
Setpoint	Heating/Cooling	Unchange
Heating valve (0-10V)	2>Assignment scene number(1-64 is active,0 is no assignment)	0
Cooling valve (0-10V)	HVAC Mode	Comfort mode
Fan	Fan Speed(if fan type is one level,all 1/2/3 mean on)	Unchange
Auto.operation	Heating/Cooling	Unchange
Fan status	3>Assignment scene number(1-64 is active,0 is no assignment)	0
	HVAC Mode	Night mode
Scene	Fan Speed(if fan type is one level,all 1/2/3 mean on)	Unchange
Output C	Heating/Cooling	Unchange

Fig. 4.25 parameter window “Scene_Local”

General	Scene function	<input type="radio"/> Disable <input checked="" type="radio"/> Enable
Interface Setting	1>Assignment scene number(1..64,0=no assignment)	0
HVAC-General	Control Value(if Valve is 2 state-ON/OFF,value>0 means on)	0
Temperature	Fan Speed(if fan type is one level,all 1/2/3 mean on)	Unchange
Heating valve (Relay)	Heating/Cooling(only used for 4-pipes of bus controller)	Unchange
Cooling valve (Relay)	2>Assignment scene number(1..64,0=no assignment)	0
Fan	Control Value(if Valve is 2 state-ON/OFF,value>0 means on)	10
Auto.operation	Fan Speed(if fan type is one level,all 1/2/3 mean on)	Unchange
Fan status	Heating/Cooling(only used for 4-pipes of bus controller)	Unchange
Scene	3>Assignment scene number(1..64,0=no assignment)	0

Fig. 4.25 Parameter setting interface“Scene_Bus”

Parameter “Assignment scene NO. (1.. 64 , 0= no assignment)”

64 different scene numbers can be assigned. Optional: 1-64 is active, 0 is no assignment.

Note: The effective scene number in the parameter setting option is 1~64, and the corresponding message is 0~63. The scene function can be saved.

Parameter “HVAC Mode”

This parameter is available when the coil control is controlled locally, setting the HVAC mode. Optional:

Standby mode

Comfort mode

Night mode

Frost/heat protection

Parameter "Control Value (if Valve is 2 state-ON/OFF(10V/0V), then value>0 means on)"

This parameter is available when the coil control is externally controlled and sets the control value. Options: 0...255

If the valve control mode is two-point control, the valve is open when the set control value is greater than zero.

Parameter "Fan Speed (if fan type is one level, all 1/2/3 mean on)"

This parameter is available when the fan is enabled and is used to set the fan speed. Optional:

Unchange

Off

1

2

3

Parameter "Heating/Cooling (only used for 4-pipes of bus controller)"

This parameter is available when the HVAC control mode is "Heating and Cooling" and the heating/cooling mode is set. Options:

Unchange

Heating

Cooling

4.6.4 Fan automatic control and coil

Automatic operation of the fan is only effective when HVAC control is enabled. The following table shows how the fan speed can be automatically operated under various control modes of the coil:

Controller	Valve control mode	Fan type	Control value type	Description
Local	2-state	One-level	—	The controller automatically switches the fan according to the temperature difference between the actual temperature and the set temperature. For the setting of the temperature difference threshold, see section 4.5.1.1;
		Multi-level	—	The controller automatically switches the fan according to the temperature difference between the actual temperature and the set temperature. For the setting of the temperature difference

	Continuous control	One-level	—	threshold, see section 4.5.2.1; The controller determines the switch of the fan according to the threshold range in which the control value is located. The control value is obtained by PI operation inside the program and will not be sent to the bus. For the setting of the threshold, see section 4.5.1.1;
		Multi-level	—	The controller determines the switch of the fan according to the threshold range in which the control value is located. The control value is obtained by PI operation inside the program and will not be sent to the bus. The threshold settings are detailed in Section 4.5.2.1;
Bus	2-state /Continuous control	One-level	1bit	Control value 0: Off the fan, control value 1: Open fan; control value is received from the bus by the object "Control value".
			1byte	The controller determines the switch of the fan according to the threshold range in which the control value is located. The control value is received from the bus by the object "Control value". The threshold settings are detailed in Section 4.5.1.1;
		Multi-level	1bit	Control value 0: off the fan, control value 1: fan speed 3; control value is received from the bus by the object "Control value".
			1byte	The controller determines the switch of the fan according to the threshold range in which the control value is located. The control value is received from the bus by the object "Control value". The threshold settings are detailed in Section 4.5.2.1;

Chapter 5 Description of Communication Objects

The communication object is the medium through which the device communicates with other devices on the bus, that is, only the communication object can perform bus communication.

The role of each communication object is described in detail below.

Note:

The "C" in the property bar of the table below represents the communication function of the communication object.

"W" means that the value of the communication object can be rewritten by the bus, and "R" means that the value of the communication object can be read through the bus.

"T" means that the communication object has a transmission function, and "U" means that the value of the communication object can be updated.

5.1 Communication objects of Switch outputs

Number *	Name	Object Function	Description	Group Address	Length	C	R	W	T	U	Data Type	Priority
1	General	In operation			1 bit	C	-	-	T	-		Low
2	General	Central switch			1 bit	C	-	W	-	-		Low
47	Output A	Switch			1 bit	C	-	W	-	-		Low
48	Output A	Switch status			1 bit	C	R	-	T	-		Low
49	Output A	Enable time function			1 bit	C	-	W	-	-		Low
50	Output A	Delay function			1 bit	C	-	W	-	-		Low
51	Output A	Operation hours counter			2 bytes	C	R	W	T	U		Low
52	Output A	Scene			1 byte	C	-	W	-	-		Low
53	Output A	Forced output			1 bit	C	-	W	-	-		Low
54	Output A	Logic 1			1 bit	C	-	W	-	-		Low
55	Output A	Logic 2			1 bit	C	-	W	-	-		Low

Fig. 5.1 Communication objects of switch outputs

No.	Function	Object name	Data type	Flags	DPT
1	General	In operation	1bit	C,T	1.001 DPT_Switch
<p>This object is always visible, used to send telegram “1” to the bus periodically to proof the device is under normal working condition.</p>					
2	General	Central switch	1bit	C,W	1.001 DPT_Switch
<p>This object is used for the central control for all switch outputs if the central control of output is enabled.</p> <p>Telegram value 0 — off 1 — on</p>					
47	Output X	Switch	1bit	C,W	1.001 DPT_Switch
<p>This object is used to trigger the switch operation. It will start the switch operation with “1”, and end with “0”. When enabling “input 0” in the logic function, the object “Switch, X” will be subject to logic functions, rather than trigger the switch operation directly. For details, please refer to the following flowchart:</p>					
<pre> graph TD A[Object "Switch, X"] --> B[Switch function] B --> C{Is logic "Input 0" enable?} C -- No --> D["switch" object value] C -- Yes --> E[Logic function] F["Object "Input 1 of logic, X""] --> E G["Object "Input 2 of logic, X""] --> E E -- Result --> H[Output (Relay to perform an action)] D --> H </pre>					
48	Output X	Switch status	1bit	C,R,T	1.001 DPT_Switch
<p>This object indicates the contact status (details will be defined by parameter “Object value of switch status:” in “Channel X: Switch”).</p>					

If selecting “respond, after read only”, the status telegram will not be sent out until receiving a read request telegrams from the bus via the object.

If selecting “respond after change”, it will send the status automatically via the object when there are any changes on the output.

If selecting “respond always” The object will not send current status to the bus, until the device received the request of reading the switch status from the other bus device operation or the bus.

49	Output X	Enable time function	1bit	C,W	1.003 DPT_Enable
----	----------	----------------------	------	-----	------------------

This object will be enabled only when enabling the time function, it can be used to enable and disable the time function. It will enable the timing function when receiving the value “1”; will disable it when receiving “0”. The operation before disabled it is still carried out completely. Enable is a default setting after bus voltage recovery if the time function is set.

50	Output X	Delay function	1bit	C,W	1.001 DPT_Switch
----	----------	----------------	------	-----	------------------

When select “delay ” in the parameter “Type of time function”, the object will be activated, then the delay switch function will be activated via the object.

50	Output X	Flashing function	1bit	C,W	1.001 DPT_Switch
----	----------	-------------------	------	-----	------------------

When select “flashing ” in the parameter “Type of time function”, the object will be activated, then the flashing switch function will be activated via the object.

50	Output X	Staircase function	1bit	C,W	1.001 DPT_Switch
----	----------	--------------------	------	-----	------------------

When select “staircase ” in the parameter “Type of time function”, the object will be activated, then the staircase lighting function will be activated via the object.

51	Output X	Operation hours counter	2byte/4byte	C,R,W,T,U	7.001 pulses/12.001 counter pulses
----	----------	-------------------------	-------------	-----------	------------------------------------

This communication object is used to report load working time, it displays when the parameter "function of " operation hours counter" select "enable" ,the data type of report value can be set in the parameter "Object datatype of "operation hours counter".

52	Output X	Scene	1byte	C,W	18.001 DPT_SceneControl
----	----------	-------	-------	-----	-------------------------

It is able to recall or save the scene when sending an 8-bit command by this object, which will be enabled when enabling the scene function. The definition of the 8-bit command will be described below:

Assuming an 8-bit command (binary coding) as: FXNNNNNN

F: recall the scene with “0”; save the scene with “1”;

X: 0

NNNNNN: scene number (0-63).

1-64 in the parameter setup corresponds to the scene number 0-63 received by the communication object “Scene”. For example, scene 1 in the parameter setup has the same output result as scene 0 in the communication object “Scene”. As follow:

Object value	Description
0	Recall scene 1
1	Recall scene 2
2	Recall scene 3
...	...

<table border="1"> <tr> <td>63</td> <td>Recall scene 64</td> </tr> <tr> <td>128</td> <td>Store scene 1</td> </tr> <tr> <td>129</td> <td>Store scene 2</td> </tr> <tr> <td>130</td> <td>Store scene 3</td> </tr> <tr> <td>...</td> <td>...</td> </tr> <tr> <td>191</td> <td>Store scene 64</td> </tr> </table>						63	Recall scene 64	128	Store scene 1	129	Store scene 2	130	Store scene 3	191	Store scene 64
63	Recall scene 64																
128	Store scene 1																
129	Store scene 2																
130	Store scene 3																
...	...																
191	Store scene 64																
53	Output X	Forced output	1bit/2bit	C,W	1.003 DPT_Enable /2.001 DPT_Switch												
<p>This object will be enabled after enabling the forced function.</p> <p>If 1bit, Enable the forced operation with “1”, and the device behaviors will be ignored except the forced function; cancel the forced operation with “0”. The contact position of force operation can be set via a parameter.</p> <p>If 2bit, the contact is forced closed when receiving telegram “3”; the contact is forced opened when receiving telegram “2”; cancel the force operation with telegram “1” or “0”.</p>																	
54	Output X	Logic 1	1bit	C,W	1.001 DPT_Switch												
<p>This object will be enabled when selecting “enable” in the parameter “The input 1 of logic”, which is used to modify logic value of input 1.</p>																	
55	Output X	Logic 2	1bit	C,W	1.001 DPT_Switch												
<p>This object will be enabled when selecting “enable” in the parameter “The input 2 of logic”, which is used to modify logic value of input 2.</p>																	

Table 5.1 Communication objects table “Switch output”

5.2 Communication object of Fan coil control

Number	Name	Object Function	Description	Group Address	Length	C	R	W	T	U	Data Type	Priority
3	General	Status of operation			1 byte	C	R	-	T	-		Low
4	Input setpoint	Base setpoint			2 bytes	C	-	W	-	-		Low
5	Input setpoint	Setpoint adjustment			2 bytes	C	-	W	-	-		Low
6	Output setpoint	Instantaneous setpoint			2 bytes	C	R	-	T	-		Low
7	Temperature	Actual temperature output			2 bytes	C	R	-	T	-		Low
8	Temperature	Local sensor error output			1 bit	C	R	-	T	-		Low
9	Temperature	External sensor			2 bytes	C	-	W	T	U		Low
27	HVAC	Scene			1 byte	C	-	W	-	-		Low
30	HVAC	Switch heating/cooling mode			1 bit	C	-	W	-	-		Low
32	HVAC mode	Night mode			1 bit	C	-	W	-	-		Low
34	HVAC mode	Standby mode			1 bit	C	-	W	-	-		Low
33	HVAC mode	Frost/heat protection mode			1 bit	C	-	W	-	-		Low
31	HVAC mode	Comfort mode			1 bit	C	-	W	-	-		Low
42	HVAC Status	Comfort mode			1 bit	C	R	-	T	-		Low
43	HVAC Status	Night mode			1 bit	C	R	-	T	-		Low
44	HVAC Status	Frost/heat protection mode			1 bit	C	R	-	T	-		Low
45	HVAC Status	Standby mode			1 bit	C	R	-	T	-		Low
46	HVAC Status	Heating/Cooling mode			1 bit	C	R	-	T	-		Low
31	HVAC mode	HVAC mode			1 byte	C	-	W	-	-		Low
42	HVAC Status	HVAC mode			1 byte	C	R	-	T	-		Low

38	HVAC	Heating mode enable	1 bit	C - W - - enable	Low
39	HVAC	Cooling mode enable	1 bit	C - W - - enable	Low

Fig. 5.2 Communication object of fan coil control

No.	Name	Object Function	Data Type	Flags	DPT																								
3	General	Status of operation	1byte	C,R,T																									
This object is used to report operation status of HVAC, definition as below:																													
<table border="1"> <thead> <tr> <th colspan="8">DPT_StatusHVAC: B6N2</th> </tr> <tr> <th>7</th> <th>6</th> <th>5</th> <th>4</th> <th>3</th> <th>2</th> <th>1</th> <th>0</th> </tr> </thead> <tbody> <tr> <td>0: Auto.(bus) operation 1: Manual operation</td> <td>0:Limit 3 disable 1:Limit 3 enable</td> <td>0:Limit 3 disable 1:Limit 3 enable</td> <td>0:Limit 2 disable 1:Limit 2 enable</td> <td>0:Limit 1 disable 1:Limit 1 enable</td> <td>0:heating 1:cooling</td> <td colspan="2">00: comfort mode 01: standby mode 10: night mode 11: protection mode</td> </tr> </tbody> </table>						DPT_StatusHVAC: B6N2								7	6	5	4	3	2	1	0	0: Auto.(bus) operation 1: Manual operation	0:Limit 3 disable 1:Limit 3 enable	0:Limit 3 disable 1:Limit 3 enable	0:Limit 2 disable 1:Limit 2 enable	0:Limit 1 disable 1:Limit 1 enable	0:heating 1:cooling	00: comfort mode 01: standby mode 10: night mode 11: protection mode	
DPT_StatusHVAC: B6N2																													
7	6	5	4	3	2	1	0																						
0: Auto.(bus) operation 1: Manual operation	0:Limit 3 disable 1:Limit 3 enable	0:Limit 3 disable 1:Limit 3 enable	0:Limit 2 disable 1:Limit 2 enable	0:Limit 1 disable 1:Limit 1 enable	0:heating 1:cooling	00: comfort mode 01: standby mode 10: night mode 11: protection mode																							
4	Input setpoint	Base setpoint	2bytes	C,W	9.001 DPT_Value_Temp																								
Benchmark sets temperature. The object is used as benchmark value for temperature setting value of each operation mode. The value is used to judge current status as cooling or heating by combining dead zone temperature under the circumstance with both heating and cooling.																													
5	Input setpoint	Setpoint adjustment	2bytes	C,W	9.001 DPT_Value_Temp																								
Benchmark sets correction of temperature. Benchmark setup temperature can be modified via written value to the object.(Relative adjustment, modifying on the original setup temperature.)																													
6	Output setpoint	Instantaneous setpoint	2bytes	C,R,T	9.001 DPT_Value_Temp																								
Temperature setup value of actual output, which is used to send temperature setup value of current operation mode to the bus.																													
7	Temperature	Actual temperature output	2Byte	C,R,T	9.001 temperature																								
This communication object is used to send the local actual temperature to the bus and is obtained from the local PT1000 sensor interface.																													
8	Temperature	Local sensor error output	1bit	C,R,T	1.005 DPT_alarm																								
Local sensor error report. When an error occurs in the temperature sensor of this device (such as PT1000), this object will send a message to the bus to report an error.																													
9	Temperature	External sensor	2byte	C,W,T,U	9.001 DPT_Value_Temp																								
When an external sensor is enabled to measure temperature, the device receives temperature measurements from the external sensor through this object.																													
27	HVAC	Scene	1byte	C,W	18.001 DPT_SceneControl																								
The object is visible when HVAC scene enables, which is used to call or save scene. 1-64 in the parameter setup corresponds to the scene number 0-63 received by the communication object "Scene". For example, scene 1 in the parameter setup has the same output result as scene 0 in the communication object "Scene".																													
30	HVAC	Switch heating/cooling mode	1bit	C,W	1.100 DPT_cooling/heating																								
The object is visible when heating/cooling switch via one object. It's used to receive telegram of switching heating and cooling, cooling with "0", and heating with "1".																													
31	HVAC mode	Comfort mode	1bit	C,W	1.003 DPT_Enable																								

		HVAC mode	1byte		20.102 DPT_HVACMode
32	HVAC mode	Night mode	1bit	C,W	1.003 DPT_Enable
33	HVAC mode	Frost/heat protection mode	1bit	C,W	1.003 DPT_Enable
34	HVAC mode	Standby mode	1bit	C,W	1.003 DPT_Enable
<p>Room operation mode can be switched via 4 objects of 1bit(object 31,32,33,34) and 1 object of 1 byte(HVAC mode).</p> <p>1 bit: object 31: room comfort mode. Object 32: room night mode. Object 33: room protection mode. Object 34: room standby mode. Meanwhile, when writing “1” in corresponding object, means enabling corresponding operation mode; “0” means canceling corresponding operation mode.</p> <p>Notes: the priority of the 4 objects if 1bit should be: (Frost/heat protection mode)> (Comfort mode)=(Night mode)=(Standby mode). When the object value of 31, 32, 33 are all zero, room operation mode is considered as standby mode by default.</p> <p>When it's 1byte: the relationship between input value and operation mode is as follows: no:0: unused.</p> <p style="margin-left: 40px;">1: comfort mode 2: standby mode 3: room mode 4: protection mode 5-255: unused</p>					
38	HVAC	Heating mode enable	1bit	C,W	1.003 DPT_Enable
39	HVAC	Cooling mode enable	1bit	C,W	1.003 DPT_Enable
<p>The two objects are visible when heating/cooling switch via two objects. Enables corresponding control mode, when object receives a telegram of “1”, and invalid of “0”.</p>					
42	HVAC Status	Comfort mode HVAC mode	1bit 1byte	C,R,T	1.003 DPT_Enable 20.102 DPT_HVACMode
43	HVAC Status	Night mode	1bit	C,R,T	1.003 DPT_Enable
44	HVAC Status	Frost/heat protection mode	1bit	C,R,T	1.003 DPT_Enable
45	HVAC Status	Standby mode	1bit	C,R,T	1.003 DPT_Enable
<p>This object is used to feedback the HVAC mode of current controller. It will be sent to the bus when changing, definition of object value refers to object 31,32,33,34.</p>					
46	HVAC Status	Heating/Cooling mode	1bit	C,R,T	1.100 DPT_cooling/heating
<p>This object is used to feedback heating/cooling status of current controller, being sent to the bus when changing, “0” means cooling, “1” means heating.</p>					

Table 5.2 Communication object of fan coil control

5.3 Communication object of Fan control

When the fan type is level 1, the communication object is as follows:

Number	Name	Object Function	Description	Group Address	Length	C	R	W	T	U	Data Type	Priority
10	Fan	Fan speed			1 bit	C	-	W	-	-		Low
15	Fan	Status Fan ON/OFF			1 bit	C	R	-	T	-		Low
26	Fan	Forced operation			1 bit	C	-	W	-	-		Low
20	Fan	Automatic function			1 bit	C	-	W	-	-		Low
21	Fan	Status Automatic			1 bit	C	R	-	T	-		Low
22	Fan	Fan Limitation 1			1 bit	C	-	W	-	-		Low
23	Fan	Fan Limitation 2			1 bit	C	-	W	-	-		Low
24	Fan	Fan Limitation 3			1 bit	C	-	W	-	-		Low
25	Fan	Fan Limitation 4			1 bit	C	-	W	-	-		Low

Fig.5.3 Communication object of Fan-one level (1)

When the fan type is multi level, the communication object is as follows:

10	Fan	Fan speed			1 byte	C	-	W	-	-		Low
11	Fan	Fan speed 1			1 bit	C	-	W	-	-		Low
12	Fan	Fan speed 2			1 bit	C	-	W	-	-		Low
13	Fan	Fan speed 3			1 bit	C	-	W	-	-		Low
14	Fan	Fan speed Up/Down			1 bit	C	-	W	-	-		Low
15	Fan	Status Fan ON/OFF			1 bit	C	R	-	T	-		Low
16	Fan	Status Fan speed			1 byte	C	R	-	T	-		Low
17	Fan	Status Fan speed 1			1 bit	C	R	-	T	-		Low
18	Fan	Status Fan speed 2			1 bit	C	R	-	T	-		Low
19	Fan	Status Fan speed 3			1 bit	C	R	-	T	-		Low
20	Fan	Automatic function			1 bit	C	-	W	-	-		Low
21	Fan	Status Automatic			1 bit	C	R	-	T	-		Low
22	Fan	Fan Limitation 1			1 bit	C	-	W	-	-		Low
23	Fan	Fan Limitation 2			1 bit	C	-	W	-	-		Low
24	Fan	Fan Limitation 3			1 bit	C	-	W	-	-		Low
25	Fan	Fan Limitation 4			1 bit	C	-	W	-	-		Low
26	Fan	Forced operation			1 bit	C	-	W	-	-		Low

Fig.5.3 communication object of Fan-Multi level (2)

No.	Name	Object Function	Data Type	Flags	DPT
10	1Level/Multi - Fan	Fan speed	1bit/ 1byte	C,W	1.001 DPT_Switch 5.001 DPT_Counter pulses
<p>To single fan speed, the object is 1bit type, which is used to switch on/off fan.</p> <p>Telegram "0"——fan OFF "1"——fan ON</p> <p>To multi fan speed, the object is 1byte, which is used to switch on/off each level fan speed. There's only one level fan speed is switching on at the same time, meanwhile, a new fan speed is switched on taking the start-up phase into consideration. Corresponding fan speed of object value is as follows:</p> <p>Telegram value:</p> <p><threshold value 1 ——the fan off >=threshold value 1 —— fan speed 1 >=threshold value 2 —— fan speed 2 >=threshold value 3 —— fan speed 3</p>					
11	Multi - Fan	Fan speed 1	1bit	C,W	1.001 DPT_Switch
<p>The communication object is available in multi level fan speed.</p> <p>The communication object can switch on the fan speed 1.</p> <p>If several On telegrams are received consecutively in a short period of time at various fan speed 1-3 communication objects, the value last received by the fan control is the decisive value.</p> <p>An OFF telegram to one of the three communication objects, fan speed 1-3, switches off the fan completely.</p> <p>Telegram value:</p>					

<p>0 — fan OFF 1 — fan ON in speed 1</p>					
12	Multi - Fan	Fan speed 2	1Bit	C,W	1.001 DPT_Switch
Refer to communication object 231					
13	Multi - Fan	Fan speed 3	1Bit	C,W	1.001 DPT_Switch
Refer to communication object 231					
14	Multi - Fan	Fan speed Up/Down	1Bit	C,W	1.008 DPT_UpDown
<p>The object is available in multi level fan speed. With this communication object, the fan can be switched one fan speed further up or down. After the maximum or minimum speed is achieved, further UP/DOWN telegrams are ignored and not executed. Telegram value: 0 — switch fan speed DOWN 1 — switch fan speed UP</p>					
15	1Level/Multi - Fan	Status Fan ON/OFF	1bit	C,R,T	1.001 DPT_Switch
<p>This object is used to send fan off/on status to the bus. As long as there's fan speed, the fan is switching on. Telegram value: "0" — fan OFF "1" — fan ON</p>					
16	Multi - Fan	Status Fan speed	1byte	C,R,T	5.010 DPT_Counter pulses
<p>The object is available in multi level fan speed. The object is used to send current operating speed to the bus. Parameter "Object value for Status Fan speed 1/2/3 [1..255]" appoint telegram value corresponded by per level fan speed. Telegram "0": fan OFF.</p>					
17	Multi - Fan	Status Fan speed 1	1bit	C,R,T	1.001 DPT_Switch
<p>The object is available in multi level fan speed. The object is used to send operating status of fan speed 1 to the bus. Telegram value "0" — fan speed 1 OFF "1" — fan speed 1 ON</p>					
18	Multi - Fan	Status Fan speed 2	1bit	C,R,T	1.001 DPT_Switch
Refer to communication object 237					
19	Multi - Fan	Status Fan speed 3	1bit	C,R,T	1.001 DPT_Switch
Refer to communication object 237					
20	1Level/Multi - Fan	Automatic function	1bit	C,W	1.003 DPT_Enable
<p>This communication object is used to activate automatic operation. After power-down reset or programming, the automatic operation whether is activated by the parameter settings. Normal operation can exit automatic operations. After the automatic operation is exited, the limit states under the automatic operation will remain, and will be activated again when the automatic operation is entered again. Under automatic operation, if the forced operation is activated, the automatic operation is still active, except that the state of the fan allowed to operate is determined by the forced operation, and the fan speed allowed under the forced operation is followed. If the parameter "carry out auto. Operation when the object value is" is set to "0": Telegram value 0 — the Auto. operation active 1 — the Auto. operation inactive If the parameter "carry out auto. Operation when the object value is" is set to "1":</p>					

<p>Telegram value 0 —the Auto. operation inactive 1 — the Auto. operation active</p> <p>The general operation as the following objects can activate the operation like: Object 10: Fan speed Object 11, 12, 13: Fan speed x (x=1,2,3,) Object 14: Fan speed UP/DOWN</p>					
21	1Level/Multi - Fan	Status Automatic	1bit	C,R,T	1.003 DPT_Enable
<p>This communication object is used to send the status of automatic operations to the bus.</p> <p>Telegram value 0 —the Auto. operation inactive 1 — the Auto. operation active</p>					
22	1Level/Multi - Fan	Fan Limitation 1	1bit	C,W	1.003 DPT_Enable
<p>The limitation 1 is active if a telegram “1” is received on the object. The limitation 1 is deactivated if a telegram “0” is received on the object.</p> <p>When the limitation 1 is activated, the fan speed at which the fan is allowed to operate under limit 1 is set by the parameter "Fan with limitation 1".</p> <p>Telegram value 0 —limitation 1 inactive 1 —limitation 1 active</p> <p>Note: limitation 1 is only active in automatic mode.</p>					
23	1Level/Multi - Fan	Fan Limitation 2	1bit	C,W	1.003 DPT_Enable
<p>Refer to communication object 242</p>					
24	1Level/Multi - Fan	Fan Limitation 3	1bit	C,W	1.003 DPT_Enable
<p>Refer to communication object 242</p>					
25	1Level/Multi - Fan	Fan Limitation 4	1bit	C,W	1.003 DPT_Enable
<p>Refer to communication object 242</p>					
26	1Level/Multi - Fan	Forced operation	1bit	C,W	1.003 DPT_Enable
<p>The communication object is used to activate the forced operation.</p> <p>When the forced operation is activated, the fan speed that the fan can operate is set by the parameter “Behaviour on Forced operation is” or“Limitation on forced operation”. Meanwhile, during Forced operation, the limits setting in Automatic operation is ignored, like the Fan Limitation 1 to 4.</p> <p>If the parameter “forced operation on object value is” is set to “0”: Telegram value 0 —forced operation 1 —no forced operation</p> <p>If the parameter “forced operation on object value is” is set to “1”: Telegram value 1 — forced operation 0 —no forced operation</p>					

Table 5.3 Communication Objects Table of Fan Control

5.4 Communication Object of Coil Output

28	HVAC	Disable,heating	1 bit	C - W - -	Low
29	HVAC	Disable,cooling	1 bit	C - W - -	Low
35	Valve Heating	Trigger valve purge	1 bit	C - W - -	Low
36	Valve Heating	Status of valve purge	1 bit	C R - T -	Low
37	Valve Heating	Status of valve position	1 bit	C R - T -	Low
39	Valve Cooling	Trigger valve purge	1 bit	C - W - -	Low
40	Valve Cooling	Status of valve purge	1 bit	C R - T -	Low
41	Valve Cooling	Status of valve position	1 bit	C R - T -	Low
34	Valve Heating/Cooling	Control value	1 bit	C - W - -	Low
38	Valve Cooling	Control value	1 bit	C - W - -	Low
42	HVAC	Control value fault	1 bit	C R - T -	Low

Fig.5.4 Communication Objects of Coil Output

No.	Object name	Object Function	Data type	Flags	DPT
28	HVAC	Disable, heating	1bit	C,W	1.003 DPT_Enable
<p>Through this communication object, the heating valve can be disabled or enabled. When disabled, the valve position is immediately adjusted back to 0% (off state), and when enabled again, the valve operates according to the current control value. For details, see the description of the relevant parameters in section 4.6.1.</p>					
29	HVAC	Disable, cooling	1bit	C,W	1.003 DPT_Enable
<p>Refer to communication object 28.</p>					
34	Valve Heating/Cooling	Control value	1bit/ 1byte	C,W	1.001 DPT_switch 5.001 DPT_Percentage
38	Valve Cooling	Control value	1bit/ 1byte	C,W	1.001 DPT_switch 5.001 DPT_Percentage
<p>The object is used to receive valve control value from other controllers. If heating valve and cooling valve share one object(34) to receive valve control value, decided by parameter setup, so heating and cooling will switch via object 30(Switch heating/ cooling mode). Control value can be 1bit or 1byte, which is decided by parameter setup.</p>					
35/39	Valve Heating/Cooling	Trigger valve purge	1bit	C,W	1.003 DPT_Enable
<p>The communication is used to trigger the valve purge. When the valve purge is triggered, the valve will be fully opened. Telegram value 0 —end valve purge 1 —start valve purge</p>					
36/40	Valve Heating/Cooling	Status of valve purge	1bit	C,R,T	1.003 DPT_Enable
<p>This communication object is used to indicate the cleaning status of the valve. Once the cleaning function is activated, its status is immediately indicated. Telegram value 0 —valve purge not active 1 —valve purge active</p>					
37/41	Valve Heating/Cooling	Status of valve position	1bit	C,R,T	1.001 DPT_switch

<p>This object is used to indicate the switch status of the valve.</p> <p>Telegram value 0 —Valve off 1 —Valve on</p>					
42	HVAC	Control value fault	1bit	C,R,T	1.005 DPT_alarm
<p>When controller is bus control, and control value monitors enabling, the object will be visible.</p> <p>When the present device can not punctually receive the control valve sent by outer controller, this object will report error of the control value. Once control value is received, error status will be relieved.</p> <p>Telegram 0—no mistake 1—mistake occur</p>					

Table 5.4 Communication Objects Table of Coil Output