

K-BUS[®] Room Controller

User manual-Ver. 2.1

AMRM-41/00.1

KNX/EIB Intelligent Installation Systems

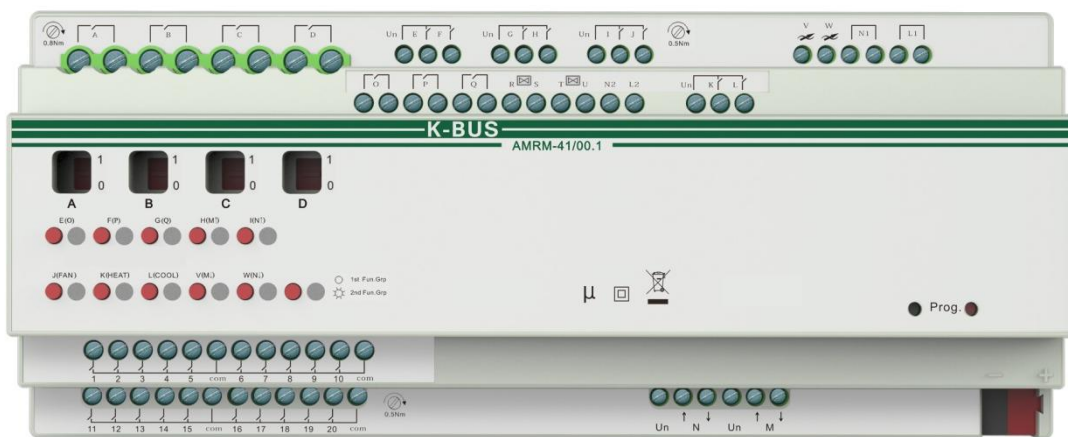

Contents

1. General	5
1.1 Product and functional overview	5
2. Technical Data	9
3. Functional, Dimension and Connection Diagram	13
3.1 Functional diagram	13
3.2 Dimension diagram	14
3.3 Connection diagram	15
4. Project design and application	16
4.1 Distribution system diagram	16
4.2 Functional overview	17
5. Parameter setting description in the ETS	17
5.1 Parameter window “General”	18
5.2 Dry contact inputs(A~T)	21
5.2.1 Parameter window“Input CH X enable”	21
5.2.2 Parameter window“Input CH X- Switch sensor”	22
5.2.3 Parameter window“Input CH X- Switch/Dimming”	28
5.2.4 Parameter window“Input CH X- Value/Forced output”	31
5.2.5 Parameter window“Input CH X- Shutter Control”	34
5.3 Switch outputs (A~L)	37
5.3.1 Parameter window“Output CH X enable”	38
5.3.2 Parameter window “Output X- Switch”	38
5.3.3 Parameter window “X: Time”	43
5.3.3.1 Selection “Delay switch”	44
5.3.3.2 Selection “Flashing switch”	45
5.3.3.3 Selection “Staircase lighting”	46
5.3.4 Parameter window “X: Logic”	48
5.3.5 Parameter window “X: Scene”	51
5.3.6 Parameter window “X: Forced	52
5.4 Shutter outputs (M~N)	53
5.4.1 Parameter window“Output CH X enable”	53
5.4.2 Parameter window“Output CH X- Shutter”	54
5.4.2.1 Parameter window “Shutter: Drive”	57
5.4.2.2 Parameter window “Shutter: Status response”	60
5.4.2.3 Parameter window “Shutter: Automatic”	63
5.4.2.4 Parameter window “Shutter: Scene”	66
5.4.2.5 Parameter window “Shutter: Safety operation”	67

5.4.3	Parameter window “Output CH X- Blind”	68
5.5	Fan speed control (O~Q)	69
5.5.1	Parameter window “Output CH X enable”	69
5.5.2	Parameter window “Fan-one level”	70
5.5.2.1	Parameter window “Fan: Auto. Operation”	74
5.5.2.2	Parameter window “Fan: Status”	78
5.5.3	Parameter “Fan-multi level”	80
5.5.3.1	Parameter window “Fan: Auto. Operation”	87
5.5.3.2	Parameter window “Fan: Status”	93
5.5.4	Parameter window “Switch-output O, P, Q”	97
5.6	HVAC system (R~U)	97
5.6.1	Parameter window “HVAC General”	99
5.6.1.1	1 Control value/2-pipe	101
5.6.1.2	1 Control value/4-pipe with switch obj.	101
5.6.1.3	2 Control value/2-pipe	103
5.6.1.4	2 Control value/2-pipe with switch obj.	104
5.6.1.5	2 Control value/4-pipe	105
5.6.2	Parameter window “OUTPUT R,S---HEATING:Continuous, PWM”	106
5.6.2.1	Parameter window “HEATING: Function”	109
5.6.2.2	Parameter window “HEATING:Curve”	114
5.6.3	Parameter window “OUTPUT R,S---HEATING:3 point, open and close”	116
5.6.4	Parameter window “OUTPUT T,U---COOLING”	121
5.7	Dimming outputs (V~W)	121
5.7.1	Parameter window “Dimmer CHX Active”	121
5.7.2	General dimming	124
5.7.2.1	Parameter window “X: dimming general”	124
5.7.2.2	Parameter window “X: dimming”	126
5.7.2.3	Parameter window “X: scene page”	129
5.7.3	Staircase lighting	131
6.	Communication Objects Description	133
6.1	Communication objects of Dry contact Inputs (A~T)	133
6.1.1	Communication objects “Switch sensor”	133
6.1.2	Communication objects “Switch /Dimming”	134
6.1.3	Communication objects “Value/force output”	134
6.1.4	Communication objects “Shutter control”	135
6.2	Communication objects of Switch outputs (A~L)	136
6.3	Communication objects of Shutter outputs (M~N)	139
6.4	Communication objects of fan control (O~Q)	143
6.4.1	Communication objects of “O, P, Q as fan speed control”	143
6.4.1.1	Communication objects of “Fan-one level”	143
6.4.1.2	Communication objects of “Fan-multi level”	146

6.4.2	Communication object of“O, P, Q as switch control”	150
6.5	Communication objects of HVAC system (R~U)	152
6.5.1	Communication objects of“HVAC General”	152
6.5.1.1	Communication objects “1 Control value/2-pipe”	152
6.5.1.2	Communication objects “1 Control value/4-pipe with switch obj.”	153
6.5.1.3	Communication objects “2 Control value/2-pipe”	154
6.5.1.4	Communication objects “2 Control value/2-pipe with switch obj.”	154
6.5.1.5	Communication objects “2 Control value/4-pipe”	155
6.5.1.6	Communication objects “Fault Control Value”	156
6.5.2	Communication objects of“OUTPUT R, S---HEATING”	156
6.5.3	Communication objects of“OUTPUT T, U---COOLING”	158
6.6	Communication objects of Dimming outputs (V, W)	159
6.6.1	Communication objects “General dimming”	159
6.6.2	Communication objects “staircase lighting”	160
7.	Manual function description	162

1. General

The room controller is a simple, low-cost solution for the hotel rooms, which can be used to achieve a single room control, such as heating, cooling, ventilation, lighting, water/fire alarm, emergency buttons and the blinds etc. But also can be used in apartments, hospitals, office buildings, assisted living facilities etc.

The room controller compact design enables cover most requirements of the electrical installation of the residential and building control systems and integrate most inputs and output interfaces for a single room automatic control as well as covers all standard functions for a single room control. It offers the following functions:

- Switch lighting
- Control heating/cooling
- Control fan coil
- Control blind or shutter
- Switching of electrical sockets and loads

In addition to these basic functions, further automation functions can be implemented by a combination with various detectors, such as a presence detector, motion detector.

The communication of the devices via the KNX bus also enables control functions as well as sending of emergency signals from the rooms to a control centre.

The integrate into a hotel management system enables the efficient management and provision of rooms. For example, when a guest checks out, the room is automatically set to standby mode. Meanwhile the hotel managers can know the use of the room at any time and the service needs etc.

This manual provides detailed technical information about the room controller for users as well as assembly and programming details, and explains how to use the room controller by the application examples.

1.1 Product and functional overview

The room controller is a modular installation device for fast installation in the distribution board on 35 mm mounting rails to DIN EN 60 715. The electrical connection is implemented using screw terminals. The connection to the KNX/EIB bus is implemented using the supplied bus connection terminal. The input need connect a 230V AC extra operating voltage. If not the 230V operation voltage, the device is also not working.

It is able to use the Engineering Tool Software ETS (ETS3 or later) with a VD4 file to allocate the physical address and set the parameters.

The room controller provides a number of input/output interfaces for a variety of function applications. the

input interfaces can be used to connect switches, button, smoke detectors, door contact and other passive switch module. The output interfaces can be used to connect fan coil unit, lighting, curtains and other load equipment.

The room controller has seven major functional modules, and each functional module is summarized as follows:

——**Dry contact input**, which can connect with a variety of passive switch module, such as general switch panel, doorbell push button, door contact, etc., which can be used to switch lighting, open/close curtain, activate Do Not Disturb and room service as well as emergency signal transmission, etc. There are 20 passive inputs, and each input offers the following functions:

- ◆ Switch function, for switching the lighting by control dimmer and switch actuator.
- ◆ Dimming function, for dimming the lighting by control dimmer.
- ◆ Control of blind and shutter, for up/down travel of a blind or a shutter, and lamella adjustment/stop travel. There are a variety of operation types, according to actual use to select them.
- ◆ Sending of values e.g temperature value, time etc.
- ◆ Control and storing of light scenes, the function can be set in the value/force output.

——**Switch output**, which can connect some electrical loads, such as lighting, sockets. There are 12 outputs, but the size of the load is different for some outputs, including 4×230V AC 16A output with manual control, 8×230V AC 6A output with manual button control in front of the device. The module offers the following functions:

- ◆ Time function: on/off delay
- ◆ Time function: flashing switch, for lamps of ageing test
- ◆ Time function: staircase lighting, for switch on the staircase lighting and after the duration time the lighting can be turned off automatically. It is better if the function is used together with motion detector.
- ◆ Provide 8 scenes, recall and storing via a 1byte object
- ◆ Logic operation: AND, OR, XOR, GATE function, up to three logic inputs
- ◆ Status response, for know the current output state in the visualization
- ◆ Forced operation, two data types: 1bit/2bit, for force action on or off, with the highest priority
- ◆ Set the relay contact position after bus voltage failure and recovery
- ◆ Manual switch outputs

——**Dimming output**, which can connect with dimmable lamps. There are two outputs with 230V AC and

current up to 1A, using SCR dimmer output, offering the follow functions:

- ◆ Switch lighting
- ◆ Relative dimming, regulation lighting brightness via increase or decrease brightness values.
- ◆ Absolute dimming, regulation lighting brightness via a brightness value.
- ◆ Status response, query and reply the current switch or brightness status to the bus, thereby indicating the status in the visualization device.
- ◆ Setting 15 scenes, the scenes can be stored or recalled via a 1byte object.
- ◆ Bus recovery function, a brightness value can be defined after bus voltage recovery.
- ◆ Staircase lighting function, for switch on the staircase lighting and after the duration time the lighting can be turned off automatically. It is better if the function is used together with motion detector. If necessary (such as cleaning stairs), you can switch on the staircase lighting for a long time via permanent on.

——**Shutter control output**, which can connect with motor blinds, awnings, roller blinds, vertical blind, etc.

There are two outputs with 230V AC 6A. The output contacts for the directions UP and DOWN are mechanically interlocked so that voltage cannot be applied at both contacts at the same time. The pause on change in direction can be set via the parameters. The functions as follows:

- ◆ Movement UP/DOWN
- ◆ Stop/Louvre adjustment
- ◆ Move to position 0.....100%
- ◆ Adjustment louvre to position 0.....100%(only“Shutter”working mode)
- ◆ Set 8 scenes, store or recall via a 1byte object
- ◆ Automatic sun protection
- ◆ Safety function
- ◆ Status response, query and reply the current shutter/blind position and operaion mode to the bus, thereby indicating the status in the visualization device
- ◆ Two working mode: Blind and Shutter

——**Fan speed control**, control a single-phase fan with up to three fan speeds. The output contact is the same with the switch output 230 V AC 6A, so the outputs (O~Q) can be also used as 3 channels switch when they are not as fan speen control. The fan functions as follows:

- ◆ Support the fan with 1 level fan speed, 2 level fan speeds or 3 level fan speeds.

- ◆ Support two control modes: step or changover control.
- ◆ Force operation: the fan speed is only allowed to run in set fan speed range, and the force operation has the highest priority.
- ◆ Auto. Operation: the desired speed is run automatically according the control value that is received from the sensor device, and the auto. Operation can be set four limits and the minimum dwell period of fan speed
- ◆ Direct operation: control the fan speeds via a manual operation, as via operating a panel
- ◆ The fan with multi-level speeds can set its starting characteristic
- ◆ The fan with single-level speed can set on/off delay or on/off minimum time
- ◆ Status response, as the current operation, fan on/off status, speed status

If as switch (relay) control, its function overview refer to the chapters 5.5.4 and 6.4.2

——**Valve control**, the output can connect 2, 3 or 4-pipe system. The heating valve and cool valve use two triac outputs separately, 0.5A 230V AC per channel. There are two control types: continuous control (3 point, open and close) and PWM (continuous control, PWM). With continuous control, the valve is brought to a position, which complies with the calculated control value, i.e. the valve can be fully opened, fully closed and even positioned in every intermediated position. The method can be implemented with the room controller for electromotor 3-point valve drives. With PWM, the valve is operated as with 2-point control exclusively in the positions fully opened and fully closed. The valve opening is calculated according to the control value and a cycle time. The valve type is distinguished de-energised closed and de-energised opened. The method can be used with the room controller in conjunction with electro-thermal valve drives. The functions as follows:

- ◆ 5 HVAC-Systems can be selected
- ◆ Fault monitoring, e.g thermostat, and send report
- ◆ Correct valve characteristic curve
- ◆ Disable or enable valve heating / valve cooling
- ◆ Forced operation
- ◆ Response or query valve position status
- ◆ purge valve via Manually or automatically, and send the valve purge status
- ◆ automatically adjust valve position (only apply to the 3 point, open and close)

It is able to use the Engineering Tool Software ETS (ETS3 version or more) with a VD3/VD4 file to allocate the physical address and set the parameters.

To guarantee all the programmable functions using correctly, you must check the connection of the loads before use and note technical characteristic of loading equipment, particularly shutter driver and fan coil, they refer more technical characteristics, some characteristics are inherent, if not properly set them, it is likely to cause the load device damage or not operating correctly.

2. Technical Data

Supply	Bus voltage	21~30V DC
	Current consumption, EIB	<12mA
	Power consumption, EIB	<360mW
	Auxiliary supply	100~240V AC
	Power consumption of Auxiliary supply	<3W
	Power consumption, Output 16A	<2W
	Power consumption, Output 6A	<3W
	Power consumption, dimmer 1A	<2W
	Power consumption, HVAC 1A	<1W
	The max. power consumption of the device	<11.36W
	Connections	EIB/KNX
Outputs, 16A		Screw terminals Wire Range 0.5-4mm ² Torque 0.8N-m

	The device of the upper Inputs/Output	Screw terminals Wire Range 0.5-1.5mm ² Torque 0.5N-m
	The device of the lower Inputs/Output (except Output 16A)	Screw terminals Wire Range 0.5-2.5mm ² Torque 0.5N-m
Operation/display	Programming button/ red LED Green LED flashing	For assignment of the physical address The application layer works normally
Housing	IP 20, EN 60 529	
Temperature range	Operation	-5°C.....+45°C
	Storage	-25°C.....+55°C
	Transport	-25°C.....+70°C
Ambient conditions	Max. air humidity	<93%, except dewing
Design	Modular installation device (MDRC)	
Housing/colour	Plastic housing, grey	
Installation	On 35mm DIN-Rail	To EN 60 715
Dimension	90 mm ×216 mm ×63mm	
Weight	1KG	
Input	20 channels	Can be individually parameterized per Input (all inputs are internally connected to the same potential)
	U _n scanning voltage	24V DC
	I _n scanning current	0.4mA
	Permissible cable length	≤10m
Output, Dimming	2 channels	Can be individually parameterized per Output
	U _n rated voltage	100~240 V AC
	I _n rated current	1A
Output, HVAC	HEAT Valve and COOL Valve	
	U _n rated voltage	85~265 V AC
	I _n rated current	0.5A

Output, 16A	4 channels	Can be individually parameterized per Output
	U _n rated voltage	250/440 V AC (50/60Hz)
	I _n rated current	16A
	Max. switching current	20A/250V AC
	Mechanical endurance	>2 × 10 ⁶
	Electrical endurance	>10 ⁵
	DC current switching capacity (resistive load)	16A/24V DC

Output, lamp load 16A	
Incandescent lamp	2500 W
Fluorescent lamp, not compensated	2500W
Fluorescent lamp, Parallel compensated	1500W
Fluorescent lamp, DUO-combination	1500W
Halogen lamp (230 VAC)	2500W
Low-voltage halogen lamp with inductive transformer	1200W
Low-voltage halogen lamp with electronic transformer	1500W
Mercury arc/sodium discharge lamp not compensated	2000W
Mercury arc/sodium discharge lamp parallel compensated	2000W
Dulux lamp, not compensated	1100W
Dulux lamp, parallel compensated	1100 W

Output, 6A	13 channels	Can be individually parameterized per Output (including switch, shutter and fan)
	U _n rated voltage	240/400V AC (50/60Hz)
	I _n rated current	6A
	Max. switching current	10A/240V AC
	Mechanical endurance	> 2 x 10 ⁶
	Electrical endurance	>10 ⁵
	DC current switching capacity (resistive load)	8A/30V DC

Output, lamp load 6A

Incandescent lamp	1200 W
Fluorescent lamp, not compensated	800W
Fluorescent lamp, Parallel compensated	300W
Fluorescent lamp, DUO-combination	350W
Halogen lamp (230 VAC)	1000W
Low-voltage halogen lamp with inductive transformer	800W
Low-voltage halogen lamp with electronic transformer	1000W
Mercury arc/sodium discharge lamp not compensated	1000W
Mercury arc/sodium discharge lamp parallel compensated	800W
Dulux lamp, not compensated	800W
Dulux lamp, parallel compensated	800W

Note: The above load is only for single lamps. In the case of several lamps in parallel, the load will be reduced, although the power is unchanged, but the instantaneous impact of current will increase, and easy to make the relay contacts melted. So, in normal use, subject to the measured current, the measured maximum inrush current must be within the allowable range.

Application program:

Model	Max. number of communicaton objects	Max. number of group addresses	Max. number of associations
AMRM-41/00.1	254	254	254

3. Functional, Dimension and Connection Diagram

3.1 Functional diagram

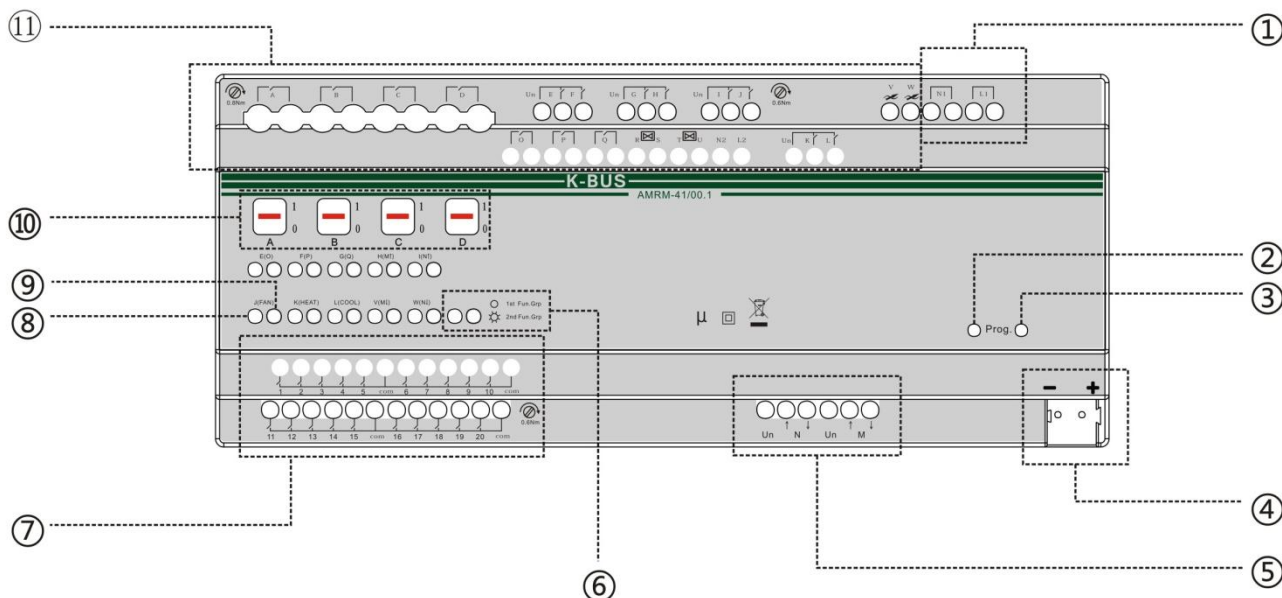

① auxiliary power supply terminals N1, L1 (except HVAC supply)

② Red LED indicates programming the physical address,

Green LED flashing indicates the application layer works normally

③ Programming button

④ Bus terminal connection

⑤ Shutter(M and N)

⑥ Functional group switch button and LED

LED off, these buttons beside it act on 1st functional group, as E、F、G、H etc.;

LED on, these buttons beside it act on 2nd functional group, as O、P、Q、M etc..

⑦ Dry contact inputs, 20 channels

⑧ Manual operation buttons of various functions:

E、F、G、H、I、J、K and L act on switch outputs;

V and W act on dimming outputs, switching by a short operation and dimming by a long operation;

O、P and Q act on switch outputs (when O、P and Q as relay control);

FAN act on/off fan and fan speeds, off the fan via a long operation, the fan speeds via a short operation, as...-1-2-3-1-2-3-...;

HEAT act on the heating valve, enable it via a short operation and disable it via a long operation;

COOL act on the cooling valve, enable it via a short operation and disable it via a long operation;

M↑↓ and N ↑↓ act on Shutter/Blind, move up/down via a long operation, louvre adjust /stop via a short operation.

⑨ To indicate output status of various functions, LED ON show the output is active.

⑩ Switch position display and manual operation, output (A, B, C and D) 16A, 1- the contact is closed, 0 - the contact is opened.

⑪ Outputs, including 12 channel switch outputs, fan coil and dimming outputs. N2 and L2 only supply to HVAC.(A~L are switch outputs,O,P,Q are fan control,R,S are for heat valve,T,U are for cool valve, V,W are for dimming outputs)

3.2 Dimension diagram

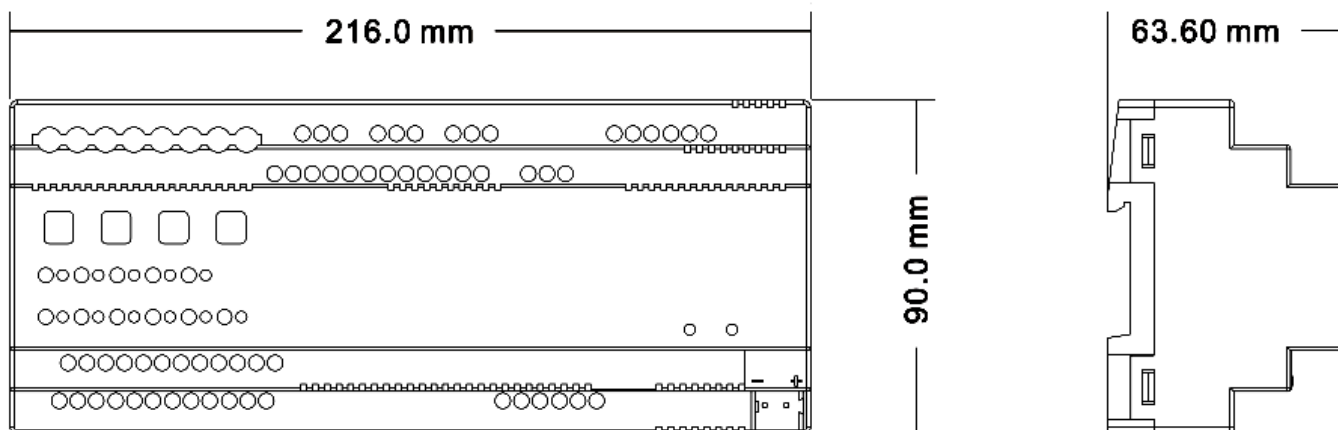

3.3 Connection diagram

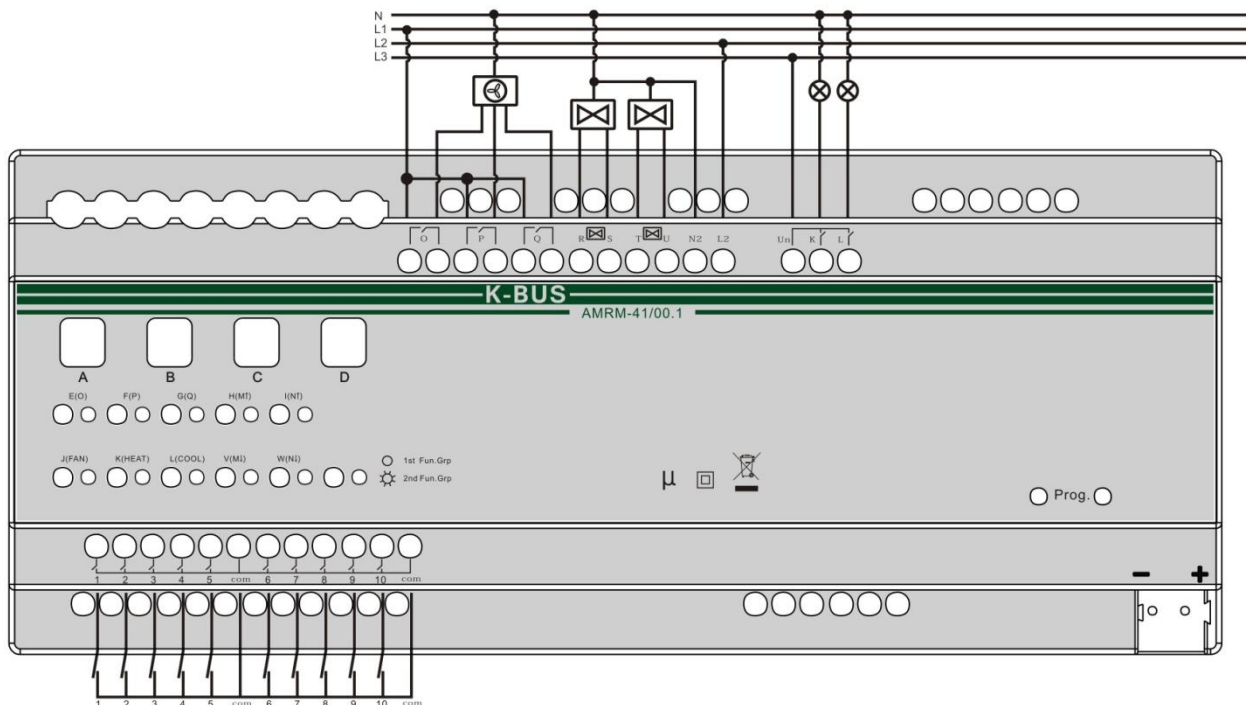
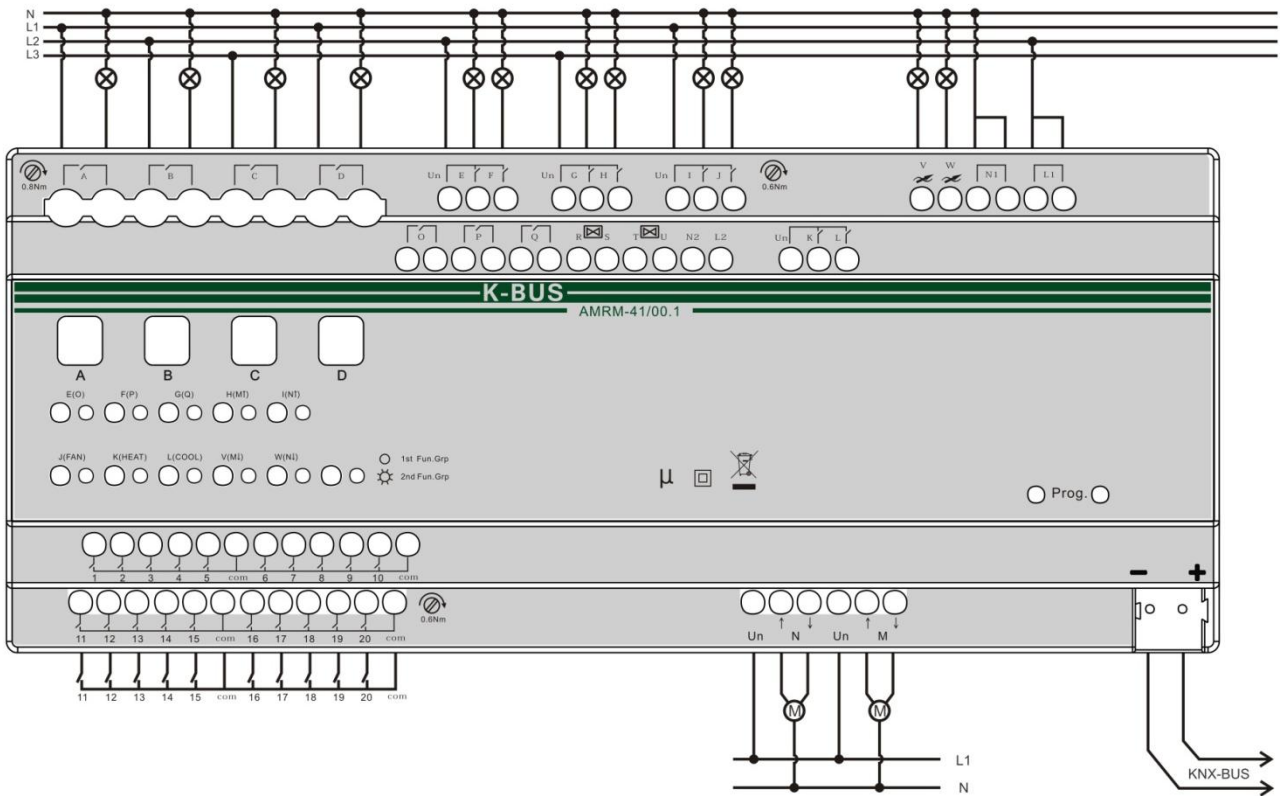

4. Project design and application

The application of the Room Controller for the hotel rooms is summarized as follows:

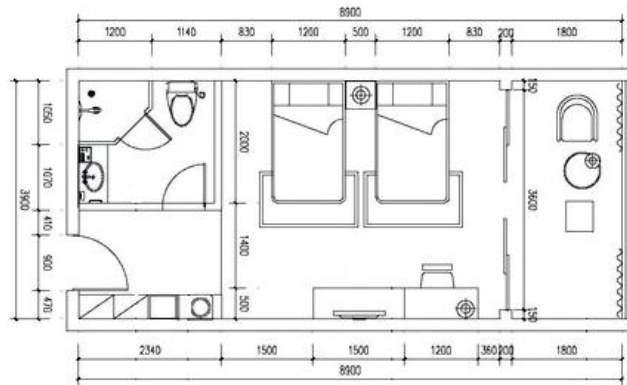

The standard room plan

4.1 Distribution system diagram

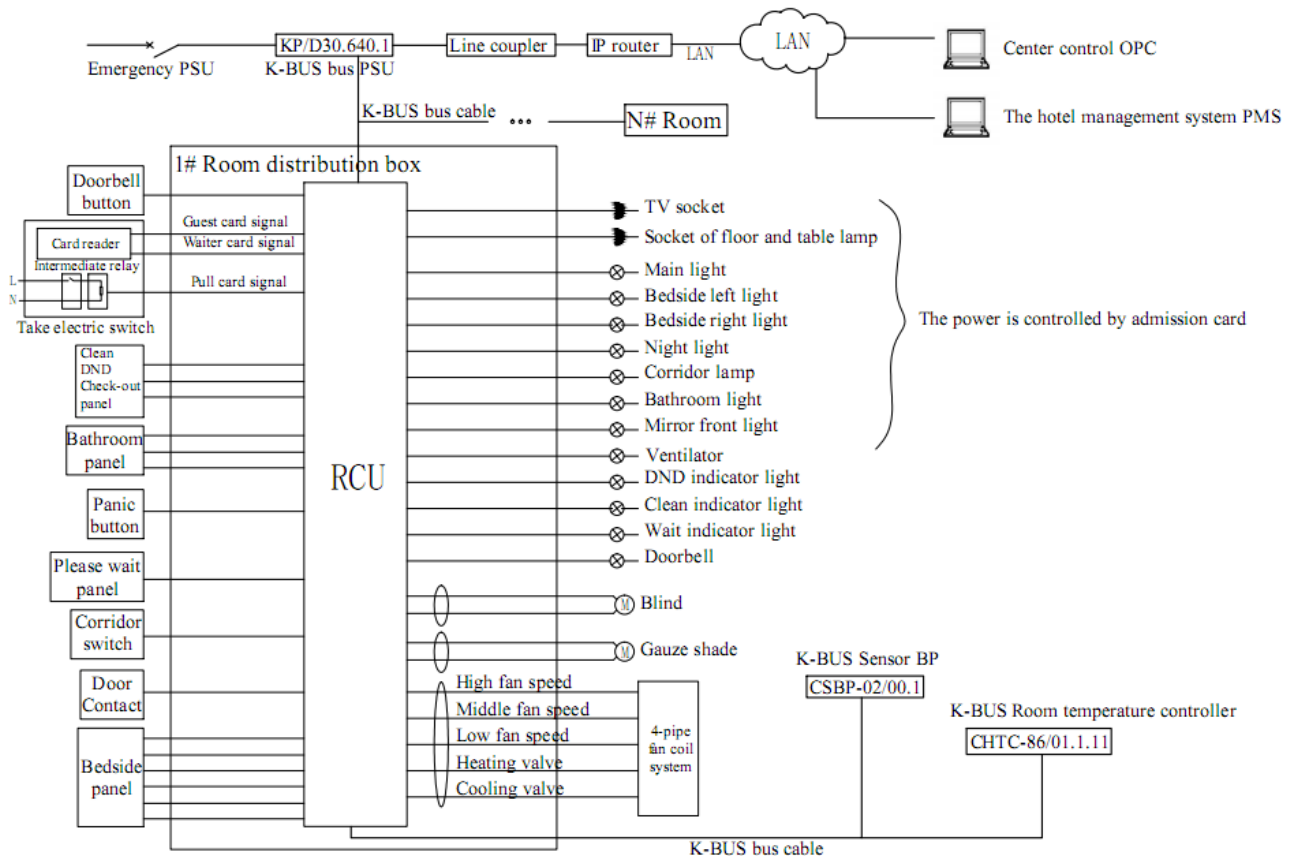

RCU: Room controller Unit (AMRM-41/00.1)

4.2 Functional overview

1. Common functions: lighting control, air-conditioning local control, air-conditioning networking control, shutter and blind control, socket control, room status monitoring.
2. Do not disturb, please clean, doorbell interlock etc.
3. To achieve the linkage control of various functions and admission card. And according to the administrator card and guest card to achieve linkage control of different scenes.
4. The fan coil unit can be controlled locally via the K-BUS Room temperature controller, and controlled remotely via the center control system of hotel. The general switch panel can be connected to the dry contact input, which is used to switch lighting, open/close curtain, activate Do Not Disturb and room service as well as scene control, etc. In addition, you had better select the panel with indicator to control night-light, to distinguish it from other panels, and features simple, easy to use.
5. Linkage control with the hotel management system and admission card: when a guest checks in, the air-conditioning of the corresponding room turns into comfortable mode. When the guest enters the room and takes electricity with admission card, the lights is adjusted automatically to the welcome mode. If the administrator enters the room, the lights will be adjusted to the clean mode. When the guest checks out, the room temperature controller is initialized via the center control system, and the air-conditioning is turned off.
6. Room control system: the computer in the housekeeping department can display in real time every room status, e.g. emergency situation, clean request etc., to improve the response time and accuracy of room service. Reception of the computer can display the operating status of controlled devices in each room, e.g. the air conditioning, lighting etc. The data exchange of intelligent control system and hotel management system can be achieved via the OPC interface, and the above linkage functions can be also achieved.

5. Parameter setting description in the ETS

The parameters will be described in the form of the function block in the follow rather than the order of the parameters in the database, to prevent duplication. The similar function block has the similar parameters.

The following chapter describes the parameters of the room controller using the parameter windows.

5.1 Parameter window “General”

Here can set the operation delay of the device and the limit number of send telegram as well as the safety operation of the shutter actuator.

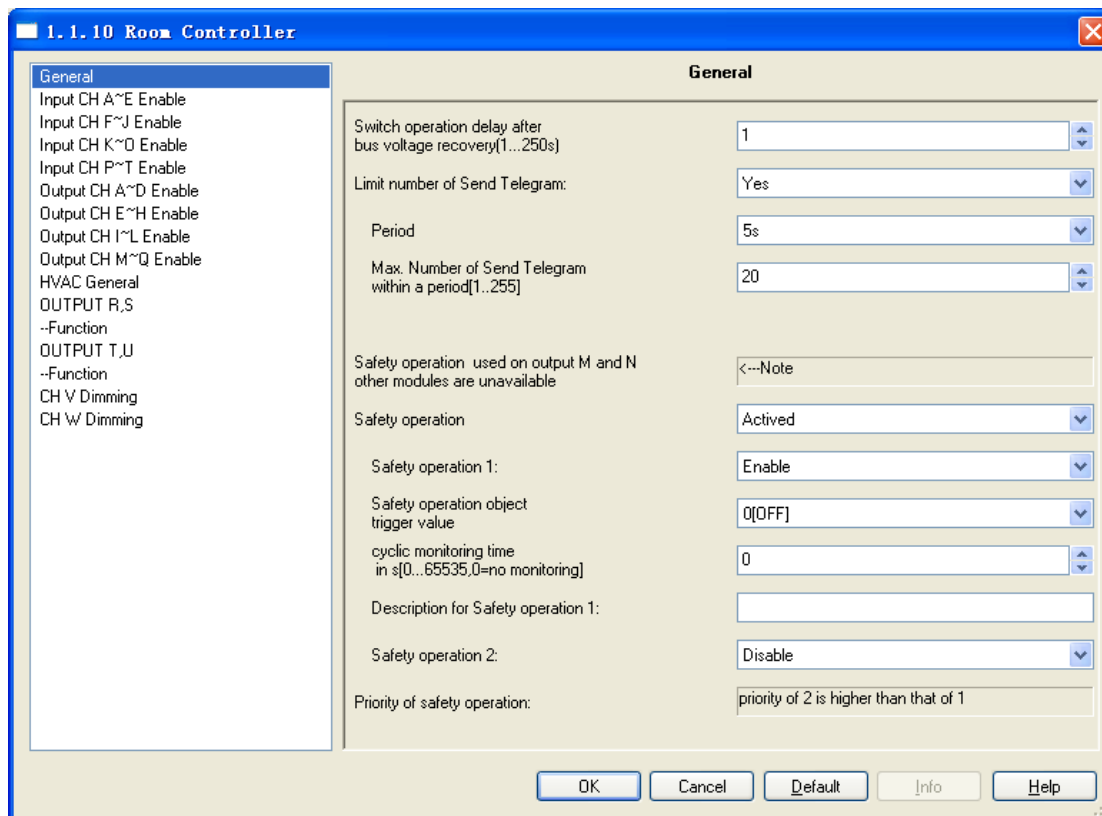

Fig. 5.1 parameter window “General”

Parameter “Scan and relay operation delay after bus voltage recovery [1...250s]”

The parameter defines the delay time that scan and relay operation after bus voltage recovery. No telegrams are sent on the bus and outputs are carried out during the scan and relay operation delay. Telegrams are only received during the scan and relay operation delay and are carried out after delay.

An initialization time of about three seconds is not included in the delay time. The initialisation time is the time that the processor requires to be ready to function.

Note: The parameter is mainly consider if a lot of equipment power on at the same time, and the relays activate simultaneously, then the power system and bus will generate an impact possibly, so it is suggested to set a different power-on delay time to each bus device.

The scan and relay operation delay does not act on the dimming outputs.

Parameter “Limit number of send telegram”

It is use to limit the number of sending telegrams to decrease the burthen of bus. It is possible to set how many

telegrams can be sent within an adjustment period.options:

Yes

No

If select“*Yes*”, the follow parameters “Period” and “Max. Number of send telegram within a period[1...255]” will visible.

Parameter “Period”

It is able to set the limit time of sending telegrams. Options:

100ms

500ms

.....

10min

After bus voltage recovery, when the initialization time and the scan and relay operation delay have been completed, the set period begins and counting the telegrams also begins. Once the max. number of telegrams has reached during the set period, the device will not send telegram to the bus until the next set period start, and the telegrams that have not been sent will be stored in buffer and send in the next set period. The buffer can store up to 20 telegrams, if there are repetitive telegrams, the telegrams will be only sent once in the next set period.

Parameter “Max.Number of send telegram within a period [1...255]”

It is able to set the Max. number of sending telegrams within a setting period. Option: 1...255

Note: the above two parameters only affect to send telegrams to the bus, and don't affect the internal connection action.

Parameter “Safety operation is only used in output M and N”< --- Note

The parameter notes the safety operation is only used in output M and N, that is shutter actuator module.

Parameter “Safety operation”

The parameter defines whether enable the safety operation of shutter/blind. Here offer two safety operations.

Options:

Activated

Deactivated

If select “*activated*”, the follow parameter “Safety operation x (x=1, 2)” will visible,the two safety operations can be set independently.

Parameter “Safety operation X (X=1,2)”

The parameter is used to set the enable status of the function “Safety operation x (x=1, 2)”. Options:

Enable

Disable

If “disable” is selected, it will not activate the function “Safety priority” ; if “enable” is selected, the follow parameters will visible, which are used to set a trigger value and the monitoring time etc. and the object “Safety operation x” will also visible.

Parameter “safety operation object trigger value”

The parameter is used to set the object trigger value of safety operation. Options:

0 [OFF]

1 [ON]

With the option “*0[OFF]*”, if the communication object “Safety operation x” receives “0”, the monitoring time of “the Safety operation x” will be reset;

With the option “*1[ON]*”, if the communication object “Safety operation x” receives “1”, the monitoring time of “the Safety operation x” will be reset.

This means, if the object “Safety operation x” doesn’t receive a corresponding telegram after the monitoring time, the Safety operation is activated, and the shutter/blind will be moved to a safety position that is defined in the parameter window “Shutter/Blind M/N:Safety operation”.

Parameter “cyclic monitoring time in s [0…65535,0=no monitoring]”

The parameter defines the monitoring time, at which the safety operation is monitored. The monitoring time in the Shutter actuator should be at least twice as long as the cyclical sending time of the sensor so that the Shutter/Blind is not immediately moved to the protect position due to the negligible omission of a signal, e.g. due to a high bus load. If the value of this parameter is set to “0”, the monitoring of the safety operation is deactivated, and their communications are also invalid.

Parameter “Description for safety operation X (X=1, 2)”(40 characters)

With the parameter, it is possible to enter a text of up to 40 characters in length for description the safety operation in the ETS, such as monitor rain sensor.

Parameter “Priority of safety operation”

The parameter notes if the two safety operations are enabled at the same time, the priority of the safety operation 2 is higher than the safety operation 1.

The priority of the safety operations is higher than other operation, if the safety operation is activated, other operation will be ignored. If the two safety operations are activated in the same time, the action of the shutter/blind will be occurred according to their priority.

Example:

Safety operation 1: Receive the signal from the anemograph

Safety operation 2: Receive the signal from the rain sensor

The anemograph and the rain sensor are monitored cyclically by the Shutter actuator i.e. the anemograph and the rain sensor send the protect status cyclically and the Shutter actuator expects this signal. If there is no signal, the Shutter actuator assumes that the anemometer and the rain sensor are faulty or that the bus line has been interrupted and moves all the Shutters/Blinds which are influenced to the set position of safety operation 2 and other operations are blocked. When the device receives a signal from the rain sensor again, the monitoring time of safety operation 2 will be reset. Meantime, the shutter/blind will be moved to the position of safety operation 1, after a time the device can also receive a signal from the anemograph, the position of shutter/blind will remain be unchanged and other operations can be also carried out as well as the monitoring time of safety operation 1 will be also reset.

The monitoring time of the Shutter actuator should be twice as long as the cyclical sending time of the anemograph and the rain sensor so that the Shutters/Blinds do not move immediately to the safety operation when a signal is omitted (e.g. due to a high bus load).

The follows parameters will be described in functional modules that are divided into the dry contact inputs, the switch outputs, the shutter outputs, the dimming outputs and the fan coil outputs.

5.2 Dry contact inputs(A~T)

There are 20 inputs. Each input can be set separately, and parameters and objects which are assigned to each input are the same. Using input A as an example described.

Usually, after the bus reset or programming, the device will detect the input state of the contacts. If the contact is closed, it is judged to input, and the corresponding object value is sent; if the contact is opened, it is no action except the parameter “send object value after bus voltage recovery” is enabled. But it is different for the function “shutter control”, if the internal connection is enabled between the function and the shutter actuator. It is very trouble for scanning the state of contact and dealing with the internal connection simultaneously after the bus reset and programming. So there is not scan the input status of contact for shutter control.

5.2.1 Parameter window“Input CH X enable”

Parameter window“Input CH X enable” can be shown in fig.5.2. Here set whether enable the input X (X=A~T) of dry contact inputs.

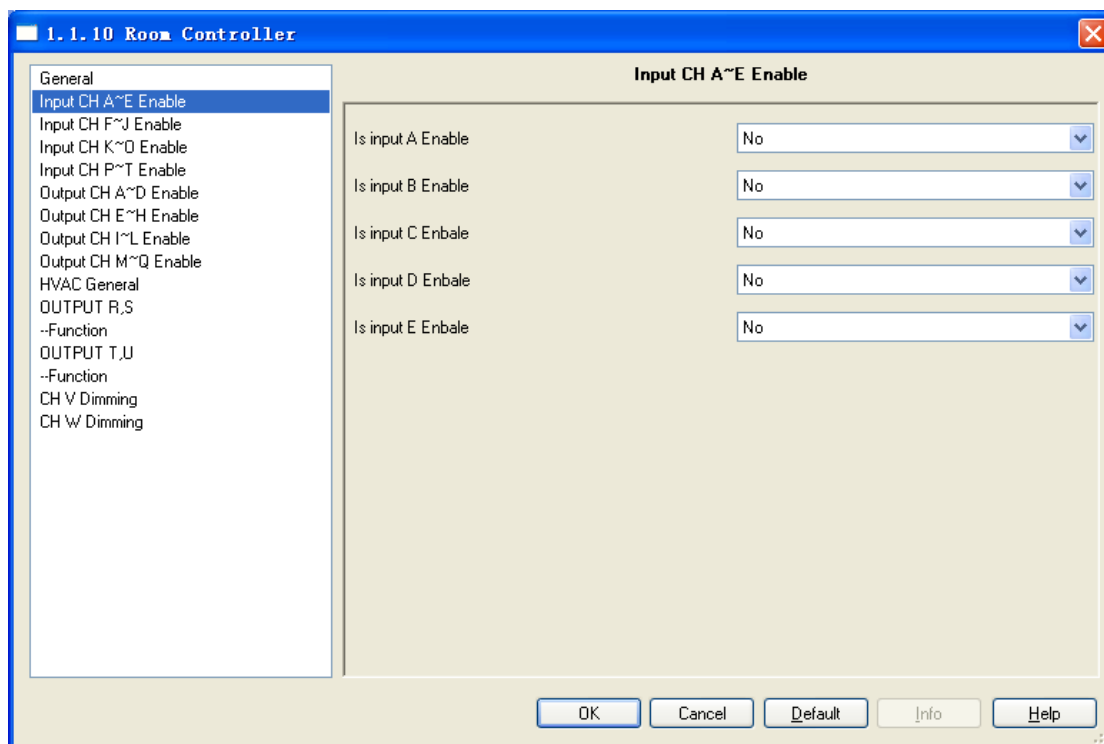

Fig. 5.2 parameter window “Input CH A~T enable”

5.2.2 Parameter window “Input CH X- Switch sensor”

Parameter window “Switch sensor” can be shown in fig. 5.3 and fig. 5.4. No distinguish between long and short operation in fig. 5.3. It is opposite in fig. 5.4.

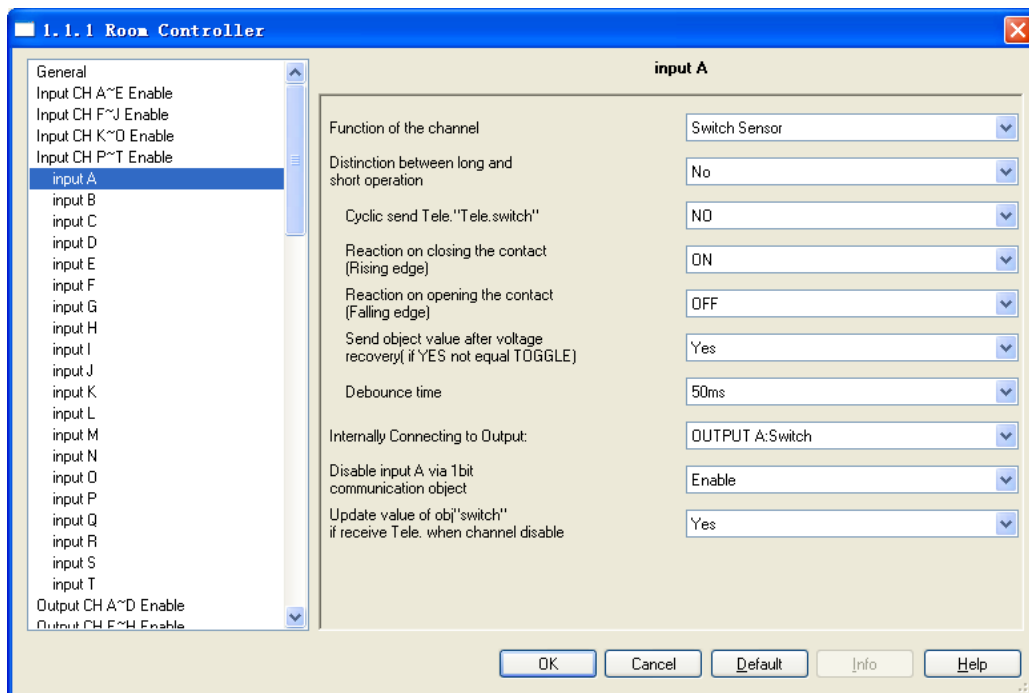

Fig. 5.3 parameter window “Switch sensor” (No distinction long/short operation)

Parameter “Function of the channel”

The parameter determines the function option in the channel; the current option is “switch”. If “No function” is selected, it means the channel is disabled. Options:

- No Function*
- Switch sensor*
- Switch/Dimming*
- Value/Forced output*
- Shutter Control*

Parameter “Distinction between long and short operation”

This parameter sets whether the input distinguishes between a short and long operation. If “yes” is selected, there is a waiting period after the opening/closing of the contact to determine whether the operation is long or short. Only then is a possible reaction triggered. The following drawing clarifies the function:

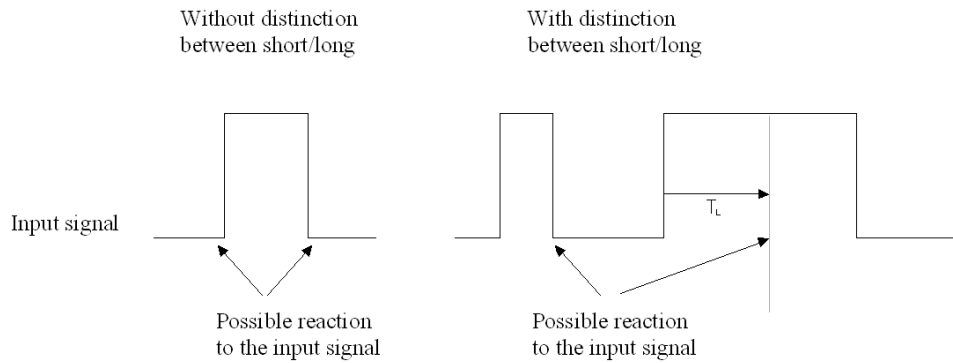

Options: *yes*
 No

Note: The long operation in the below chapters are the same with here. T_L is the time duration from where a long operation is detected.

Parameter “Cyclic send Tele. “Tele. Switch” ”

This parameter is visible if there is no distinction between a short and long operation. It is able to set whether to send the current value of object “switch operation” cyclically on the bus. Options:

- No*
- Always*
- If switch off*
- If switch on*

If the parameter value “always” is selected, the object sends its value cyclically on the bus, regardless of its value is 0 or 1. If the parameter value “if switch off” or “if switch on” is set, only the corresponding object value is sent cyclically.

Parameter “Reaction on closing the contact (rising edge)” / “Reaction on opening the contact (fall edge)”

This parameter is visible if there is no distinction between a short and long operation. It can be set the operation to open and close the contact.

- Options:
- No action*
 - Off*
 - On*
 - Toggle*
 - Stop cyclic send*

If the parameter “Toggle” is selected, negate the operation, that means negate the current value. For example, if “On” is carried out, when negate it will carry out “Off” operation next.

If the parameter “Stop cyclic send” is selected, it will stop the cyclical sending telegram till there is a new object value to be sent.

If the parameter “No action” is selected, it will not implement any operation.

Parameter “Interval of Tele. cyclic send: Base × Factor”

This parameter is used to set the interval time between two telegrams that are sent cyclically, it is visible if cyclical sending has been set. Transmission cycle time = Base × Factor.

Base options: 1s
 10s
 ...
 1h
Factor options: 1...255

Parameter “Send object value after voltage recovery (if yes not equal toggle)”

It can be set whether to send the value of the object “switch operation” on the bus after voltage recovery, this parameter is visible if there is no distinction between a short and long operation. Options:

Yes
No

If the parameter “Yes” is selected, it will send the current value of the object “switch operation” on the bus. Only when the value “Toggle” has not been set in either of the two parameters “Reaction on opening/closing the contact”, the value of the object “switch operation” can be send on the bus. If one of the two parameters has the value “TOGGLE”, no values are sent in general on the bus after bus voltage recovery. If “No action” or “Stop cyclic send” is selected, there is no values are sent on the bus either.

Parameter “Debounce time”

It can set the debounce time to prevent unwanted multiple operation by bouncing of contacts in debounce time, which means the effective time of the contact operation.

10ms
20ms
.....
150ms

Parameter “Internally Connecting to Output”

With this parameter a direct connection of the dry contact input with a switch output can be established. With this connection no assignment of the group address is possible. Options:

Disconnect
OUTPUT A: Switch
OUTPUT B: Switch
.....
OUTPUT P: Switch

OUTPUT Q: Switch

The internal connection omits the link with a group address between objects, for example, you just need to set parameters of inputA and enable OUTPUT A to realize the inputA to control the OUTPUT A, and then if the switch object value of inputA is updated, the switch object value of OUTPUT A is also updated together. Meanwhile, the switch object value of OUTPUT A can be also updated via other bus devices, but the OUTPUT A will carry out action with the last received value.

If the OUTPUT O, P, Q as a fan speed control, the internal connection is invalid, if as relay control, it is available.

Parameter “Disable input X via 1bit communication object”

The parameter defines whether enable the object “input A Enable communication”. Options:

Disable

Enable

With the option “enable”, the object “Enable communication” will visible, if it receives a telegram “0”, the input X will be disabled, if “1”, it will be enabled.

After bus voltage recovery, the input X is enabled by default.

During disable, the value that the object “switch operation” receives will be ignored.

Note: the parameter of input X other functions also has the same function, the following will not repeat the description.

Parameter “Update value of obj ‘switch’ if receive Tele. When channel disable”

The parameter set whether the object “switch” value can be updated when the input is disabled. Options:

Yes

No

Yes: after disabled, the object “switch” value can be modified via the bus.

No: after disabled, the object “switch” value can not be updated.

Note: the parameter is not act on internal connection.

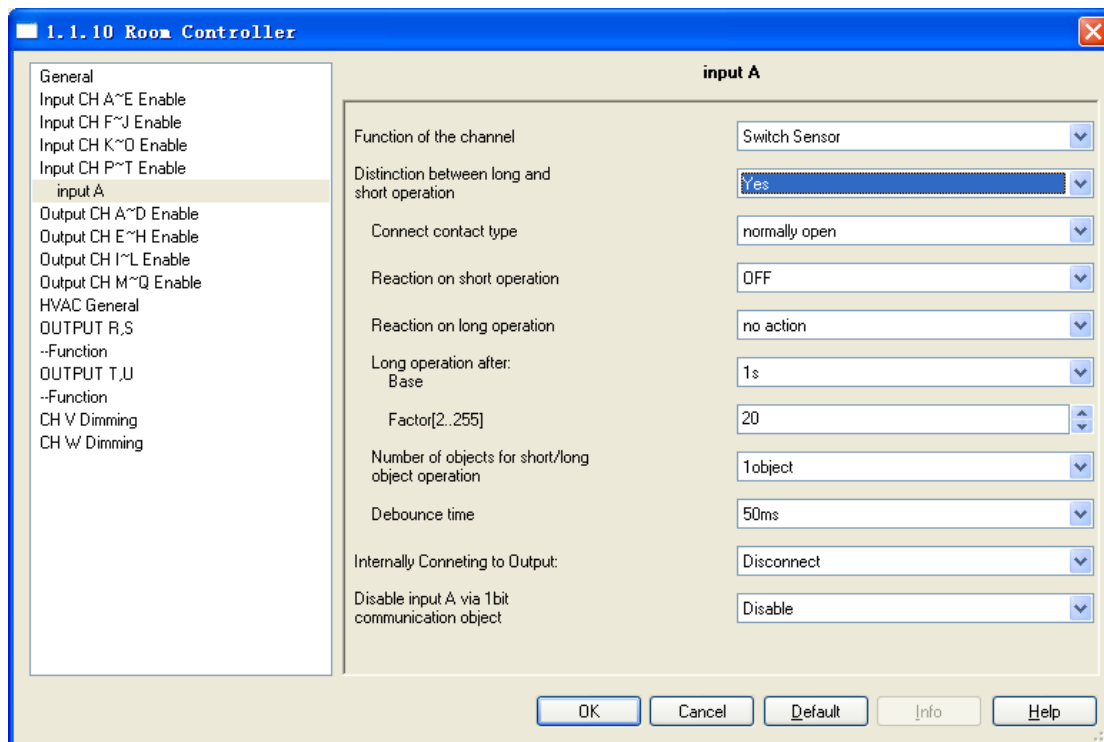

Fig. 5.4 parameter window “Switch X” (Distinction long/short operation)

Parameter “Connect contact type”

This parameter is visible if there is distinction between a short and long operation. It is used to set whether the input contact is a normally closed or normally open contact. Options:

- Normally open*
- Normally close*

The parameters that are described in this chapter are based on normally open connect type as example, the normally close connect type is just opposite.

Parameter “Reaction on short operation” or “Reaction on long operation”

The parameter is visible if the option yes has been selected with the parameter distinction between long and short operation. It is used to set if the object value is ON, OFF, TOGGLE, or if no action should be occur. The object value is updated as soon as it has been determined if a short or long operation has occurred. Options:

- No action*
- Off*
- On*
- Toggle*

Parameter “Long operation after: Base xFactor”

The parameter is visible if the option yes has been selected with the parameter distinction between long and short operation. Here defines the period T_L after which an operation is interpreted as “long”. $T_L = \text{Base} \times \text{Factor}$.

Base options: 100s
 Is

 Ih
 Factor options: 2~255

Parameter “Number of objects for short/long object operation”

The parameter is visible if the option yes has been selected with the parameter distinction between long and short operation. It is able to set one or two communication objects for short/long operation. When one communication object is set, long and short operations share a communication object. When two communication objects are set, long and short operations use a communication object separately. Options:

1object
 2objects

If selecting “2objects”, the internal connection is determined by a short operation. It is not affected by a long operation.

5.2.3 Parameter window “Input CH X- Switch/Dimming”

Parameter window “Switch/Dimming” can be shown in Fig.5.5. It is visible when Function of the input “Switch/Dimming” is selected. It is possible that switch and dimming the lighting via an input.

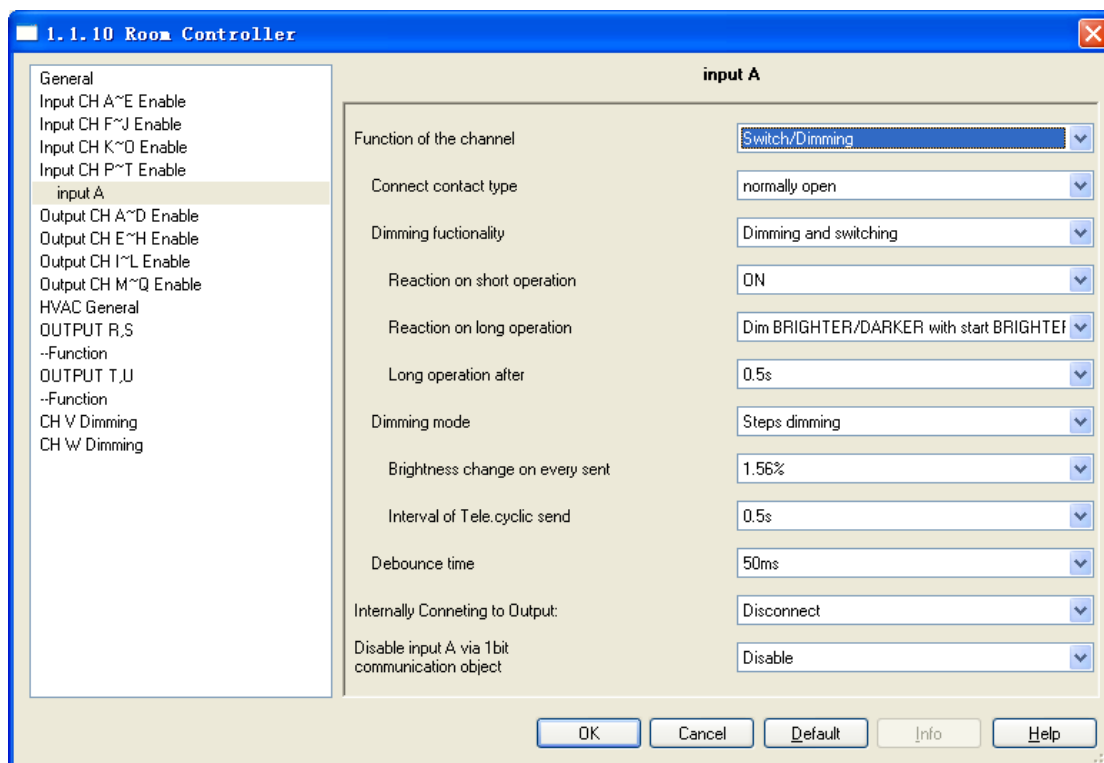

Fig. 5.5 parameter window “Switch / Dimming”

Parameter “Connect contact type”

This parameter defines whether the input contact is a normally closed or normally open contact.

Options: *Normally open*
 Normally closed

The parameters that are described in this chapter are based on normally open connect type as example, the normally close connect type is just opposite.

Parameter “Dimming functionality”

This parameter is used to define whether the lighting can only be dimmed or whether it also should be permitted switching. In this case a long operation actuated dimming and a short operation actuates switching.

Options: *Dimming and switching*
 Only dimming

If “Only dimming” is selected, there is no distinction between a short and long operation. Therefore the dimming is carried out immediately after an operation action; there is not required to determine whether the operation is long or short.

If “Dimming and switching” is selected, it will distinguish the operation is a short or long operation. In this case, the lighting is dimmed via a long operation and switched via a short operation.

Parameter “Reaction on short operation”

The parameter is visible if the option “dimming and switching” has been selected with the parameter dimming functionality. It is used to set if the value of object “Switch dimming” is ON, OFF, TOGGLE, or if no action should be occur with short operation.

Options: *No action*
 Off
 On
 Toggle

Parameter “Reaction on long operation”

The parameter is visible if the option “dimming and switching” has been selected with the parameter dimming functionality. It is used to set if the object “dimming” sends a brighter or darker telegram with long operation. When the operation is over, the object will send a stop dimming telegram.

Options: *Dimming BRIGHTER*
 Dimming DARKER
 Dim BRIGHTER / DARKER with start BRIGHTER
 Dim BRIGHTER / DARKER with start DARKER

If the option “Dim BRIGHTER / DARKER with start DARKER” is selected, the dim command which is the opposite to the last dim command is set, and the first action is dimming darker with long operation. Other options

are similar with the option.

Parameter “Long operation after”

The parameter is visible if the option “dimming and switching” has been selected with the parameter dimming functionality. Here defines the period T_L after which an operation is interpreted as “long”.

Options: *0.3s*
 0.5s

 10s

Parameter “Reaction on operation”

The parameter is visible if the option “only dimming” has been selected with the parameter dimming functionality. There is no distinction between short and long operation. Therefore the object “dimming” will send a brighter or darker telegram after an operation trigger. When the operation is over, the object will send a stop dimming telegram.

Options: *Dimming BRIGHTER*
 Dimming DARKER
 Dim BRIGHTER / DARKER with start BRIGHTER
 Dim BRIGHTER / DARKER with start DARKER

Parameter “Dimming mode”

The parameter sets whether the dimming mode is start-stop dimming or steps dimming.

Options: *Start-stop dimming*
 Steps dimming

If the option start-stop dimming is selected, it will start the dimming mode with a bright or darker telegram and end the dimming mode with a stop dimming telegram at the end of operation. The dimming telegram need not be cyclically sent in start-stop dimming mode.

If the option step dimming is selected, the dimming telegram is sent cyclically during a long operation. The stop telegram ends the dimming process at the end of operation.

Parameter “Brightness change on every sent”

The parameter is visible if the option step dimming has been selected with the parameter dimming mode. It is used to set the change brightness (in percent) which is cyclically sent with every dim telegram.

Options: *100%*
 50%

 1.56%

Parameter “Interval of Tele. Cyclic send”

The parameter is visible if the option step dimming has been selected with the parameter dimming mode. It is used to set the interval time between two telegrams that are sent cyclically during a long operation.

Options: 0.3s
 0.5s

 10s

Parameter “Debounce time”

This parameter is used to set the debounce time. Debouncing prevents unwanted multiple operation of the input, e.g. due to bouncing of the contact. Options:

Options: 10ms
 20ms

 150ms

Parameter “Internally Connecting to Output”

With this parameter a direct connection of the dry contact input with a dimming output can be established. With this connection no assignment of the group address is possible. Options:

Disconnect
OUTPUT V: Dimmer
OUTPUT W: Dimmer

The internal connection omits the link with a group address between objects, for example, you just need to set parameters of inputA and enable OUTPUT V to realize the inputA to control the OUTPUT V, and then if the switch dimming object value of inputA is updated, the switch object value of OUTPUT V is also updated together. Meanwhile, the switch object value of OUTPUT V can be also updated via other bus devices, but the OUTPUT V will carry out action with the last received value. So it is with the relative dimming.

5.2.4 Parameter window “Input CH X- Value/Forced output”

Parameter window “Value/Forced output” can be shown in Fig. 5.6. It is visible when Function of the channel “Value/Forced output” is selected.

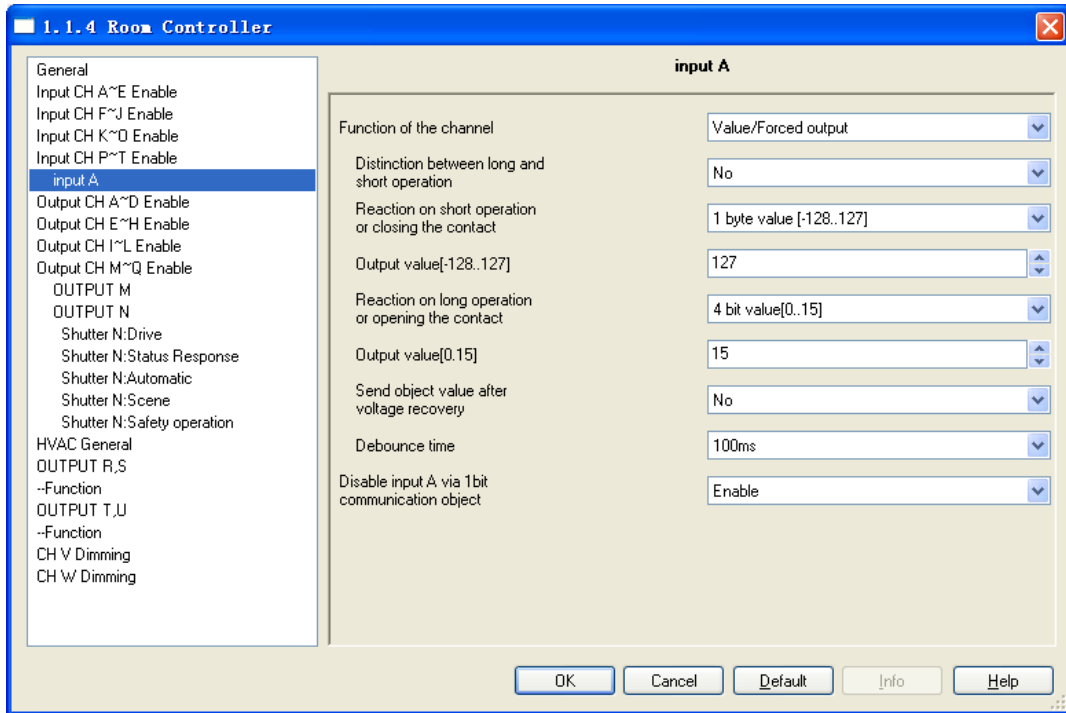

Fig. 5.6(1) parameter window “Value / Force output” (No distinction long/short operation)

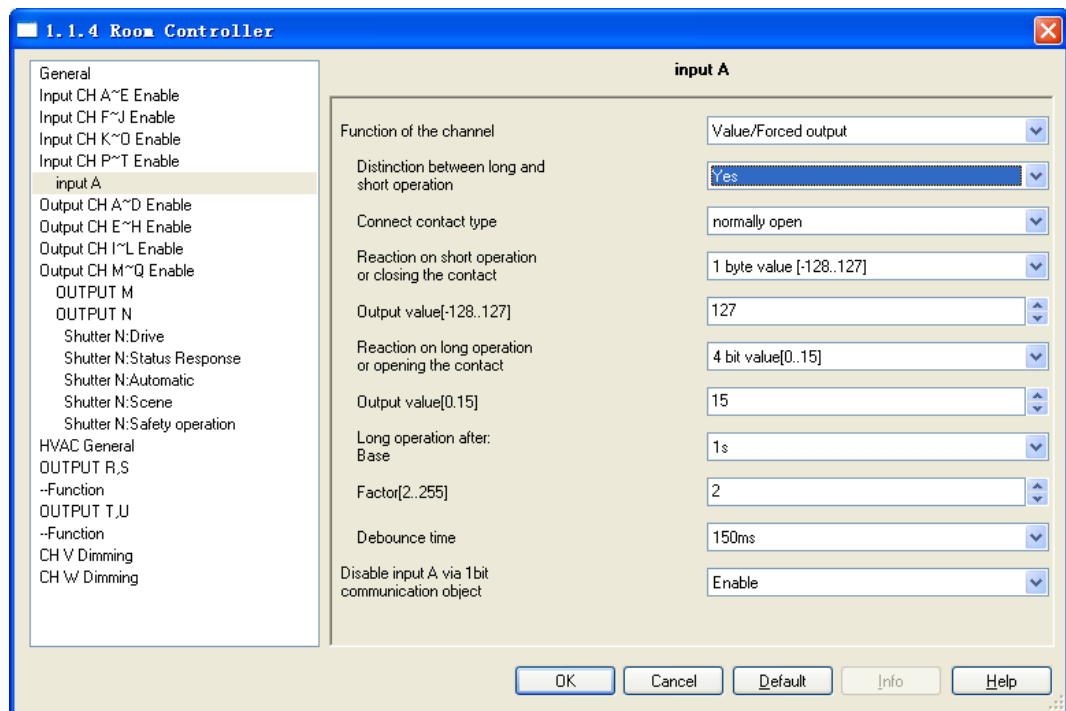

Fig. 5.6(2) parameter window “Value / Force output” (Distinction long/short operation)

Parameter “Distinction between long and short operation”

This parameter defines whether the input distinguishes between a short and long operation. If “yes” is selected,

there is a delay after opening/closing the contact to determine whether there is a short or long operation. Only then is a possible reaction triggered.

Options: *Yes*
 No

Parameter “Connect contact type”

This parameter is visible if there is distinction between a short and long operation. It is used to set whether the input contact is a normally closed or normally open contact. Options:

Normally open
Normally closed

The parameters that are described in this chapter are based on normally open connect type as example, the normally close connect type is just opposite.

Parameter “Reaction on short operation or closing the contact” and “Reaction on long operation or opening the contact”

If there is distinction between short and long operation, the parameter is used to define the data type that is sent when the contact is actuated with short or long operation. If no distinction, it defines the data type that is sent when the contact is actuated with closing or opening. Options:

No reaction
1bit value [0/1]

4 byte value [0...4294967295]

Parameter “Output value [···]”

Here defines the value which is sent with the operation. The value range depends on the data type set for the parameter “Reaction on short operation or closing the contact” or “Reaction on long operation or opening the contact”

Parameter “Send object value after voltage recovery”

This parameter is visible if there is no distinction between a short and long operation as shown in fig. 5.6(1). It can be set whether to send the value of the object “...-long/open (short/close)” on the bus after bus voltage recovery.

Options:
 Yes
 No

If “Yes” is selected, the object value will be sent on the bus after bus voltage recovery.

Parameter “Long operation after: Base×Factor [2···255]”

The parameter is visible if the option “yes” has been selected with the parameter distinction between long and short operation. Here defines the period T_L after which an operation is interpreted as “long”. $T_L = \text{Base} \times \text{Factor}$.

Base options: *100ms/1s/...../1h*

Factor options: *2~255*

Parameter “Debounce time”

This parameter is used to set the debounce time. Debouncing prevents unwanted multiple operation of the input, e.g. due to bouncing of the contact. Options:

10ms/20ms/...../150ms

5.2.5 Parameter window “Input CH X- Shutter Control”

Parameter window “Shutter control, X” can be shown in fig. 5.7. It is visible when the input is operated with the function “shutter control”. The function enables the operation of blinds and shutters with buttons or switches.

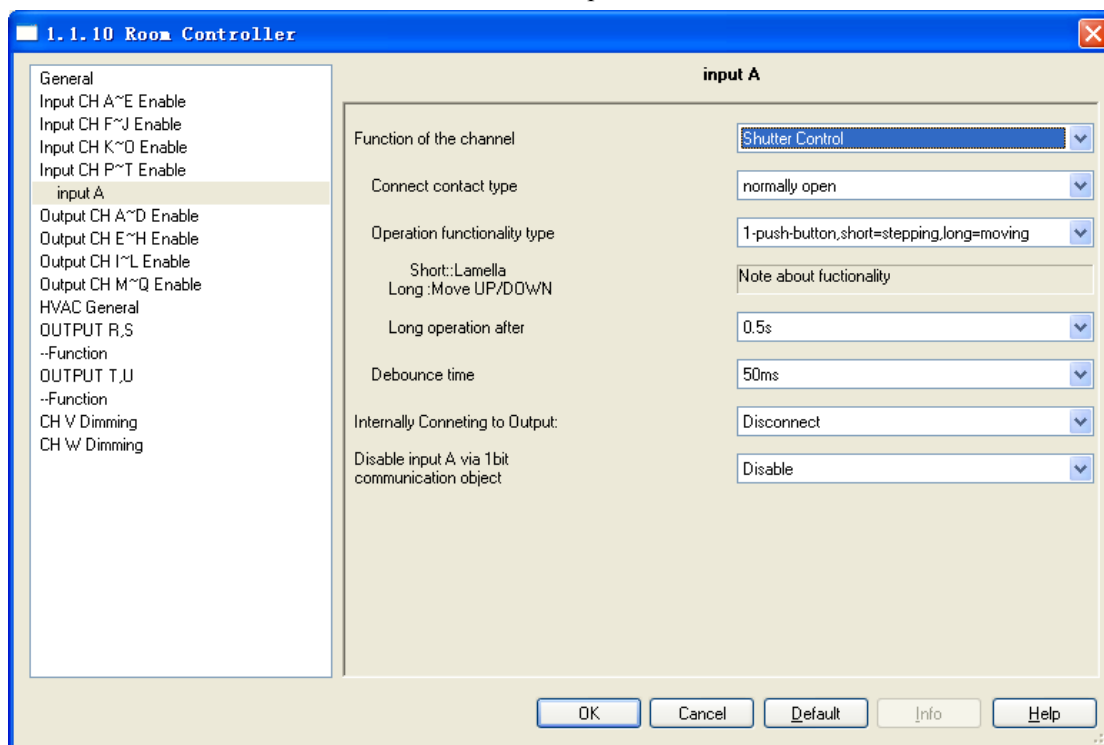

Fig. 5.7 parameter window “Shutter control”

Parameter “Connect contact type”

This parameter is used to set whether the input contact is a normally closed or normally open contact.

Options:

Normally open

Normally closed

The parameters that are described in this chapter are based on normally open connect type as example, the normally closed connect type is just opposite.

Parameter “Operation functionality type”

This parameter sets the shutter operating functionality type, which overview is provided in the following tables.

According to the actual use, select an appropriate operation type.

1-push-button,short=stepping, long=moving	
Short operation	Alternate implement “Stop/Adjust upward” or “Stop/Adjust downward” operation. (alternate send the value of the object “0”and“1”)
Long operation	Alternate implement “Move up” or “Move down” operation. (alternate send the value of the object “0”and“1”)
1-push-button, short=moving, long=stepping	
Short operation	Alternate implement “Move up” or “Move down” operation (alternate send the value of the object “0”and“1”)
Long operation	Alternate implement “Stop/Adjust upward” or “Stop/Adjust downward” operation (keep pressing the button can send cyclic) (alternate send the value of the object “0”and“1”)
1-push-button-operation, moving	
On operation	When operation,send the command in sequence: - >Move up - >Stop/Adjust upward - >Move down->Stop/Adjust downward->.....
1-switch-operation, moving	
Start of operation (contact closed)	Alternate implement “Move up” or “Move down” operation (alternate send the value of the object “0”and“1”)
End of operation (contact open)	Stop/Adjust
2-push-button, standard	
Short operation	“Stop/Adjust upward” or “Stop/Adjust downward” (set by parameter)
Long operation	“Move up” or “Move down”(set by parameter)
2-push-button, moving[shutter]	

On operation	When operation,send the command in sequence:->Move up->Stop/Adjust upward->..... or->Move down->Stop/Adjust downward->..... (Move up/down set by parameter)
2-push-button, stepping	
On operation	“Stop/ Adjust upward” or “Stop/ Adjust downward” (set by parameter) (keep pressing the button can send cyclic)
2-switch-operation, moving[shutter]	
Start of operation (contact closed)	“Move up” or “Move down”(set by parameter)
End of operation (contact open)	“Stop / Adjust upward” or “Stop / Adjust downward” (the sending value is identical to the value that the operation starting)

Parameter “Long operation after”

This parameter is visible if long operation activate, it defines the period T_L here, after which an operation is interpreted as “long”.

Options: *0.3s/0.5s/.../10s*

Parameter “Tele. STOP/lamella adj” Cyclical send”

It is visible if the shutter control type is “1-push-button, short=moving, long=stepping” and “2-push-button, stepping”. It is able to set the interval time of sending the object “stop/adjust adj.” cyclical.

Options: *0.3s/0.5s/.../10s*

Parameter “Reaction on short operation”

It is visible if the shutter control type is “2-push-button, standard”. This parameter defines the operation with short operation. Options:

Stop/lamella up
Stop/lamella down

Parameter “Reaction on long operation”

It is visible if the shutter control type is “2-push-button, standard”. This parameter defines the operation with long operation. Options:

Move up
Move down

Parameter “Reaction on operation”

It is visible if the shutter operation functionally type is “2-push-button, moving [shutter]”, “2-switch-operation, moving [shutter]” and “2-push-button, stepping”. It defines the action when operation. Different operation functionally type makes different operate action. The former two operations functionally type is move up and down; the last operation functionally type is stop/lamella reaction.

Options: *Move up*

Move down

Options: *Stop/lamella up*

Stop/lamella down

Parameter “Debounce time”

This parameter is used to set the debounce time. Debouncing prevents unwanted multiple operation of the input, e.g. due to bouncing of the contact.

Options: *10ms/20ms/.../150ms*

Parameter “Internally Connecting to Output”

With this parameter a direct connection of the dry contact input with a shutter output can be established. With this connection no assignment of the group address is possible. Options:

Disconnect

OUTPUT M: Shutter

OUTPUT N: Shutter

The internal connection omits the link with a group address between objects, for example, you just need to set parameters of inputA and enable OUTPUT M to realize the inputA to control the OUTPUT M, and then if the shutter UP/DOWN object value of inputA is updated, the shutter UP/DOWN object value of OUTPUT M is also updated together. Meanwhile, the shutter UP/DOWN object value of OUTPUT M can be also updated via other bus devices, but the OUTPUT M will carry out action with the last received value. So it is with the Louvre adj. /Stop.

5.3 Switch outputs (A~L)

There are 12 outputs. Each output can be set separately, and parameters and objects which are assigned to each output are the same. Using output A as an example described.

5.3.1 Parameter window “Output CH X enable”

Parameter window “Output CH X enable” can be shown in fig.5.8. Here set whether enable the output X (X=A~L) of switch outputs.

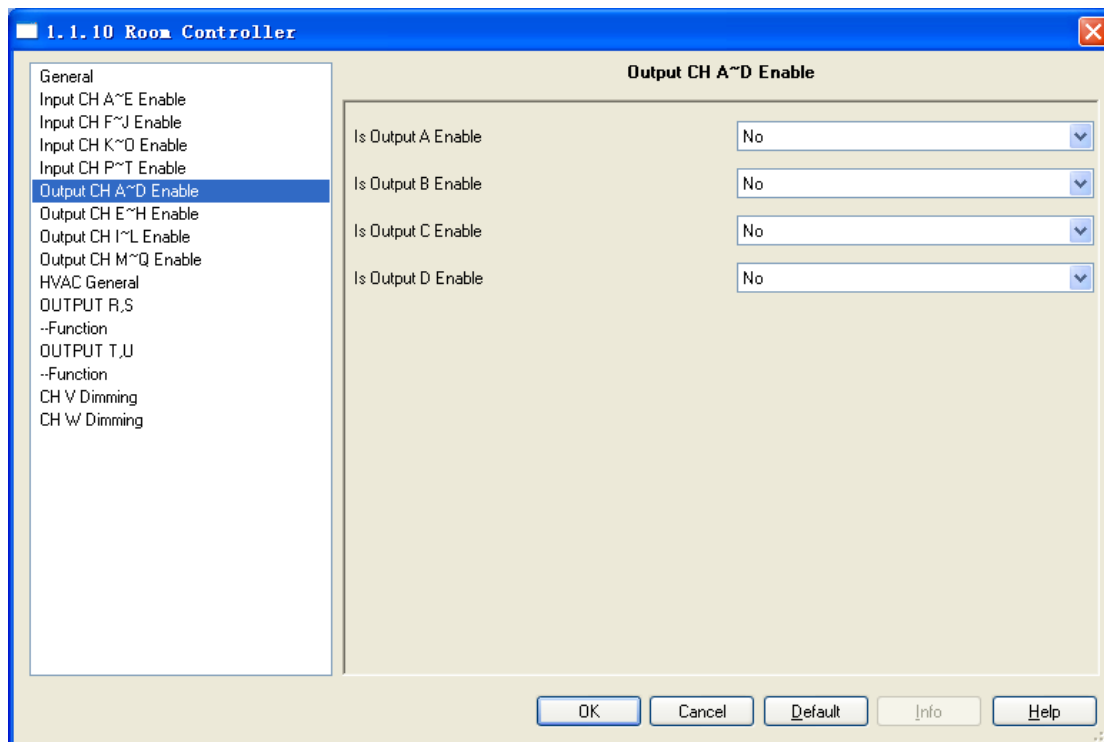

Fig. 5.8 parameter window “Output CH A~L enable”

5.3.2 Parameter window “Output X- Switch”

Parameter window “Switch” can be shown in fig. 5.9, which applies to a whole output. In addition to setting general switching function, but also set position of switch on the bus power on and power down , reports of switch status, etc..

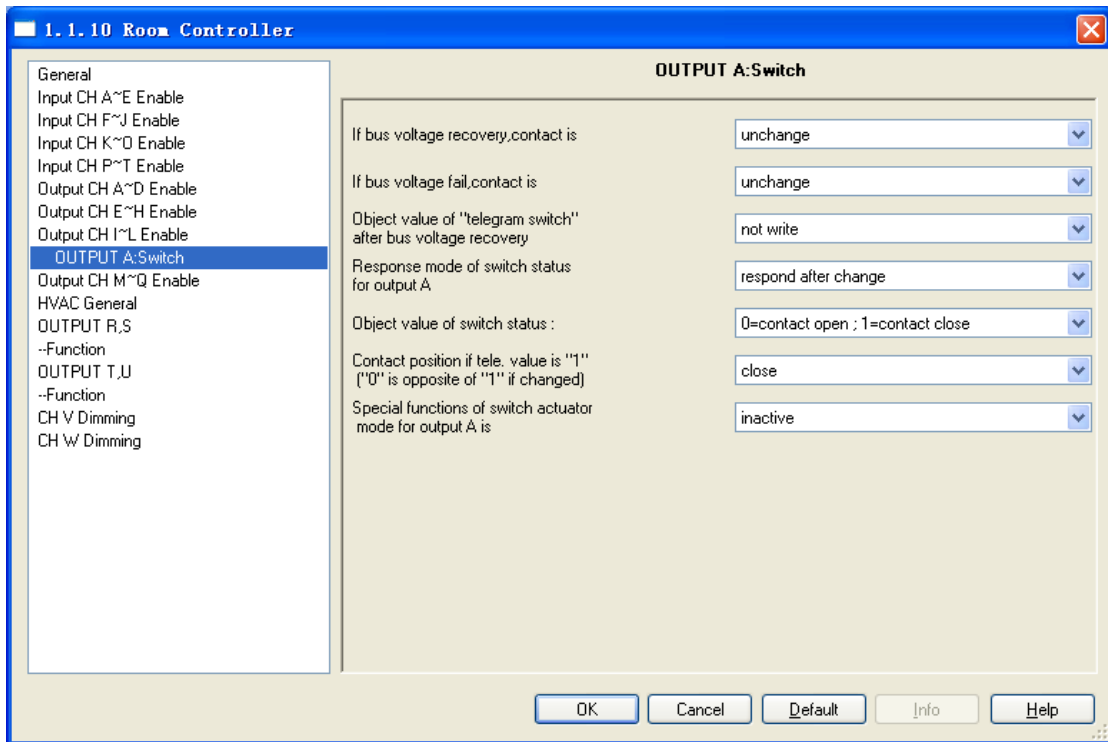

Fig. 5.9 parameter window “Switch”

Parameter “If bus voltage recovery, contact is”

The output can adopt a defined status on bus voltage recovery via this parameter.

- Options:
- unchanged*
 - Open*
 - Closed*
 - As before bus voltage fail*

When selecting “Unchanged”, the contact of the relay will remain the same as the last status on the bus power on. When selecting “open”, the contact will be open; while it is closed when selecting “closed”. The contact position after voltage recovery is the same as that before the bus power off with “As before bus voltage fail”.

Note:

The operation voltage of relays needs a 230V AC auxiliary power supply, so only when the supply is normal, the relay will execute the set position after bus voltage recovery. The other outputs of the section 5.3 are similar to this, so in any case you must ensure that the auxiliary power supply is normal.

When the dry contact input is associated to the output, the action of the output need to be considered the switch object value associated with input after bus voltage recovery, if the value is certain, the output will execute the action according the object value (the next fig.5.10), if uncertain, it will execute the action via the parameter setting on bus voltage recovery.

Parameter “If bus voltage fail, contact is”

The output can adopt a defined status after the bus voltage failure via this parameter.

Options: *unchanged*
Open
Closed

When selecting “Unchanged”, the contact of the relay will remain the same as the last status before power off; when selecting “open”, the contact will be open; while it is closed when selecting “closed”.

Parameter “Object Value of “Telegram Switch” after bus voltage recovery”

This parameter will be used when enabling the logic function “input 0” to define the default value of the communication object “Switch, X” after bus voltage recovery, which can be “0” or “1”. If selecting “not write”, the value “0” is written into the object “Telegram Switch” and remains until this value is changed via the bus.

Options: *not write*
To write with 0
To write with 1

Parameter “Response mode of switch status for output X”

This parameter defines how to respond the current switch status to the bus. There are three options to select.

Options: *no respond*
Respond, after read only
Respond after change

If selecting “no respond”, there is no telegram to send out for report the current switch status.

If selecting “respond, after read only”, the status telegram will not be sent out until receiving a read request telegrams via the object “reply switch status” from the bus.

If selecting “respond after change”, it will send the status automatically via the object “reply switch status” when there are any changes on the output.

The value (“0” or “1”) of the communication object “reply switch status” defines the current status of the switch, which can be set in the parameter “Object value of switch status:” (when selecting “respond, after read only” or “respond after change”).

Parameter “Object value of switch status:”

This parameter will be visible when selecting “respond, after read only” or “respond after change” in the parameter “respond mode of switch status for output X” . Options:

0=contact close; 1=contact open
0=contact open; 1=contact close

It means the contact of the relay will be closed when the value of the communication object “reply switch status” is 0 when setting “0=contact close; 1=contact open” , while it is open when the value is “1” .

It means the opposite with setting “0=contact open; 1=contact close” .

Note: after programming or bus reset, all communication object values default to 0. In the case the last parameter is set to “respond after change”, if the object “reply switch status, X” value is changed after bus reset or programming, it will send the status, if not change, no send.

Parameter “Contact position if tele. Value is ‘1’ (‘0’ is opposite of ‘1’ if changed) ”

This parameter defines the contact position when switch on the switch, which will be triggered by the communication object “switch, X”. When enabling “input 0” in the logic function, it will use the communication object “switch, X” to modify the value of “input 0”, rather than triggering the switch operation. In this case, this parameter is no significance to the switch. Similarly, it is still no significance when the time function is enabled.
Options:

- Unchanged*
- Open*
- Close*

The contact position stays the same with “unchanged”; it will be off with “Open”, and on with “Close”. When ending the operation, position will be reversed if it is changed after starting (for instant, selecting “open” or “close”), otherwise, it will remain the same.

Note: The parameter only works after the object “Switch x” receiving value, and defines the direction of the contact after receiving it. More details can be found in the below form:

Parameter options	“Switch, X” object value =1	“Switch, X” object value =0
Unchanged	Unchanged	Unchanged
Open	Contact open(OFF)	Contact close (ON)
close	Contact close (ON)	Contact open (OFF)

Since the switch, time and logic functions share the same object “switch, X” , thus need to understand the relationship between them, the control sequence shown below (the time and logic functions, please refer to the following chapter describe):

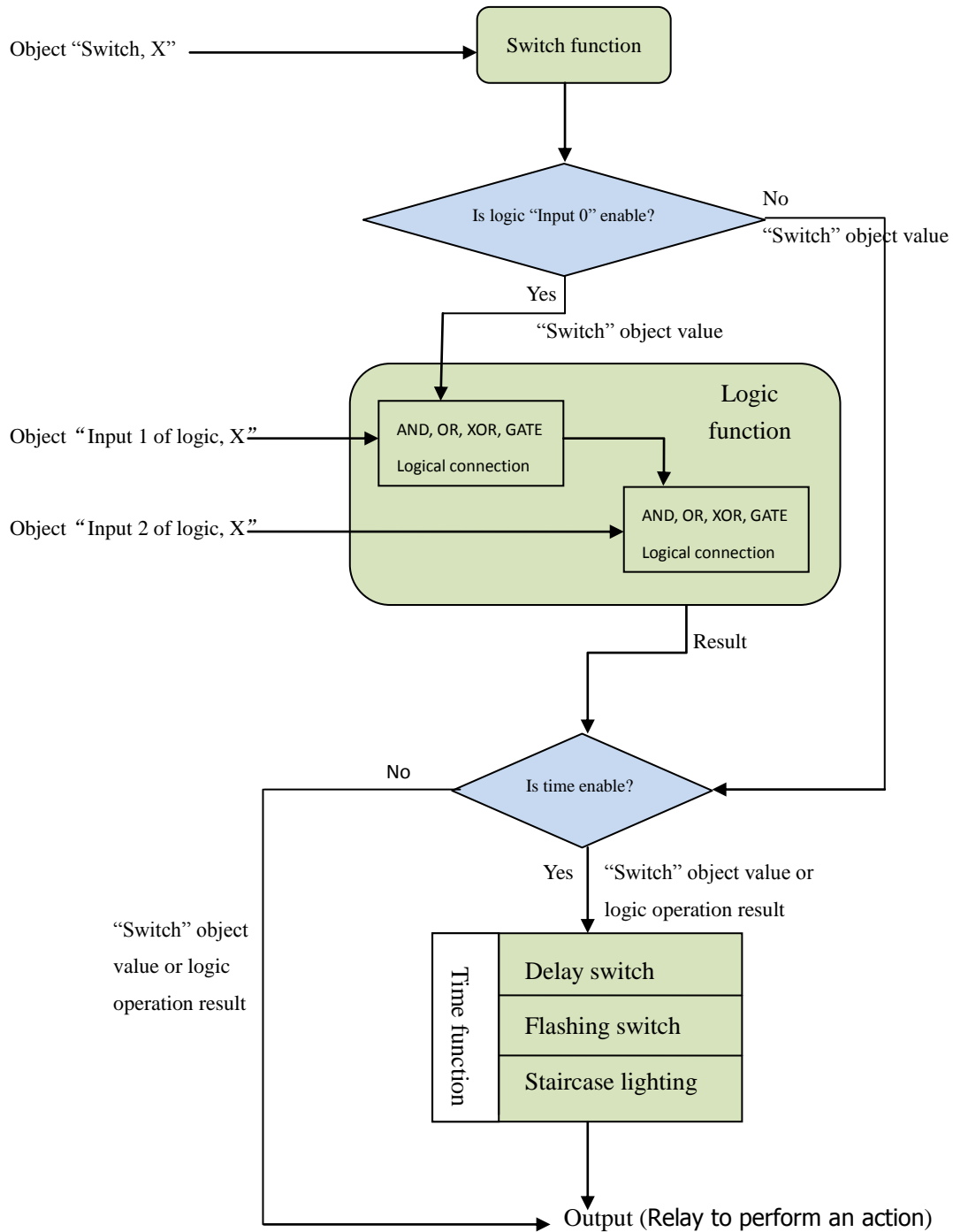

Fig. 5.10 switch, time and logical function diagram

Example:

If the delay switch function is active, and the logic function is not activated, then the “switch” object value will be used to trigger delay switch function; if the delay switch function is disabled via the object “disable time function” , then the “switch” object value will be used to trigger the general switch operation.

Parameter “Special functions of switch actuator mode for output X is”

This parameter defines whether enable the special functions of the switch actuator. The parameter window “X: Function” will be seen with “active”, and able to set the special functions individually in Fig. 5.11. Enable or disable the special function in “X: Function”.

Options: *active*
 Inactive

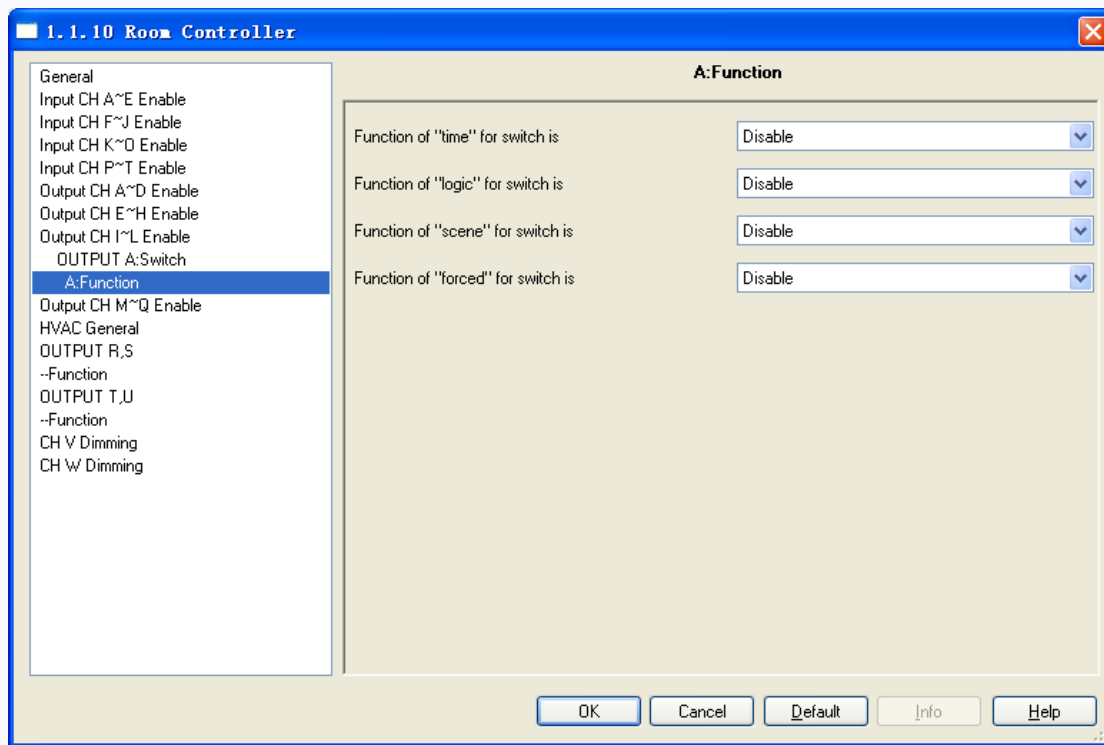

Fig. 5.11 the special function enable window “X:Function”

5.3.3 Parameter window “X: Time”

This parameter window will become visible when selecting “enable” in the parameter “Function of “time” for switch is” for switch is” in the window “X:Function”. See Fig. 5.12. And the object “enable time function” will be also visible, which is used to disable the time function. After disabled, previous operation is still carried out completely. Such as delay switch on, the function is disabled during delay, and then the switch is still switched on once the delay has been finished.

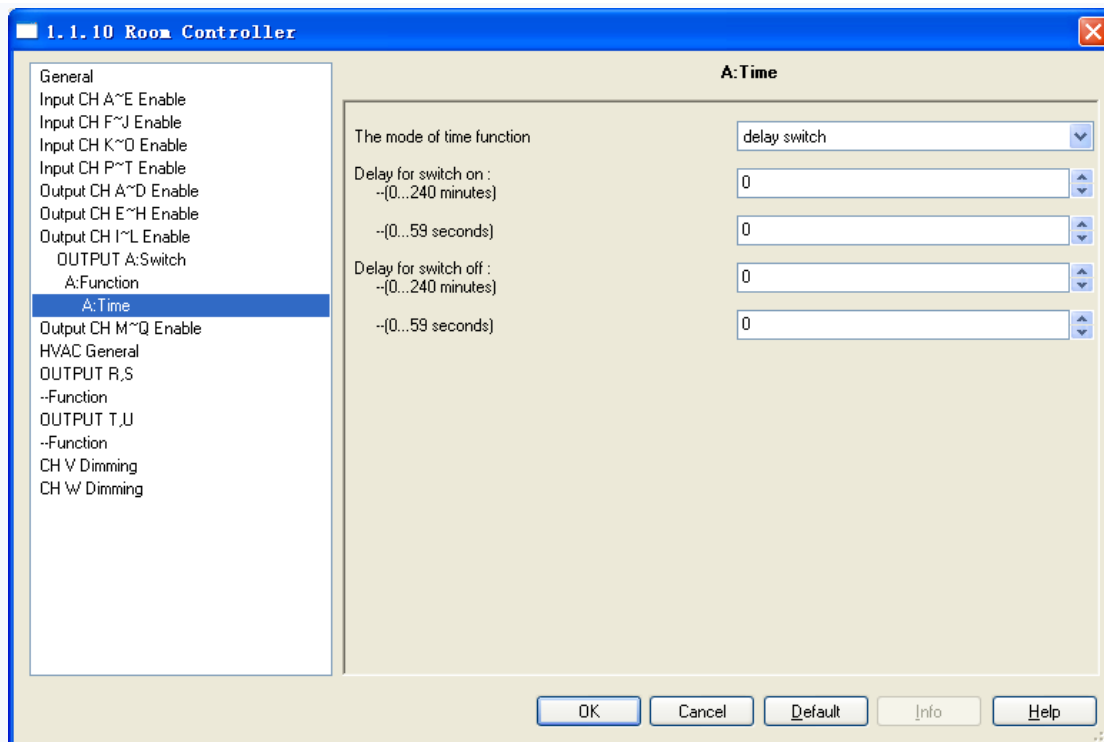

Fig. 5.12 parameter window “X: Time-Delay switch”

Parameter “The mode of time function”

The parameter defines the mode of the time function.

- Options: *Delay switch*
 Flashing switch
 Staircase lighting

5.3.3.1 Selection “Delay switch”

The parameter window of the delay switch in Fig. 5.12 will be shown when selecting “Delay switch”. The delay switch can be started via the object “switch, X”, as shown in fig. 5.10

Parameter “Delay for switching on: (0...240 minutes)/ (0...59 seconds)”

This parameter defines the delay time of switching on.

- Options: *0...240 minutes*
 0...59 seconds

After receiving the relevant telegram, the switch is on once the delay over.

Parameter “Delay for switching off: (0...240 minutes) / (0...59 seconds)”

This parameter defines the delay time of switching off.

Options: 0...240 minutes
0...59 seconds

After receiving the relevant telegram, the switch is off once the delay over.

If receiving the relevant telegram again during delay, the delay will be reset.

5.3.3.2 Selection “Flashing switch”

The parameter window in Fig. 5.13 “X: Time-flashing switch” will be shown up when selecting “flashing switch” in the parameter “The mode of time function”. The flashing switch function is mainly used for lamp aging test.

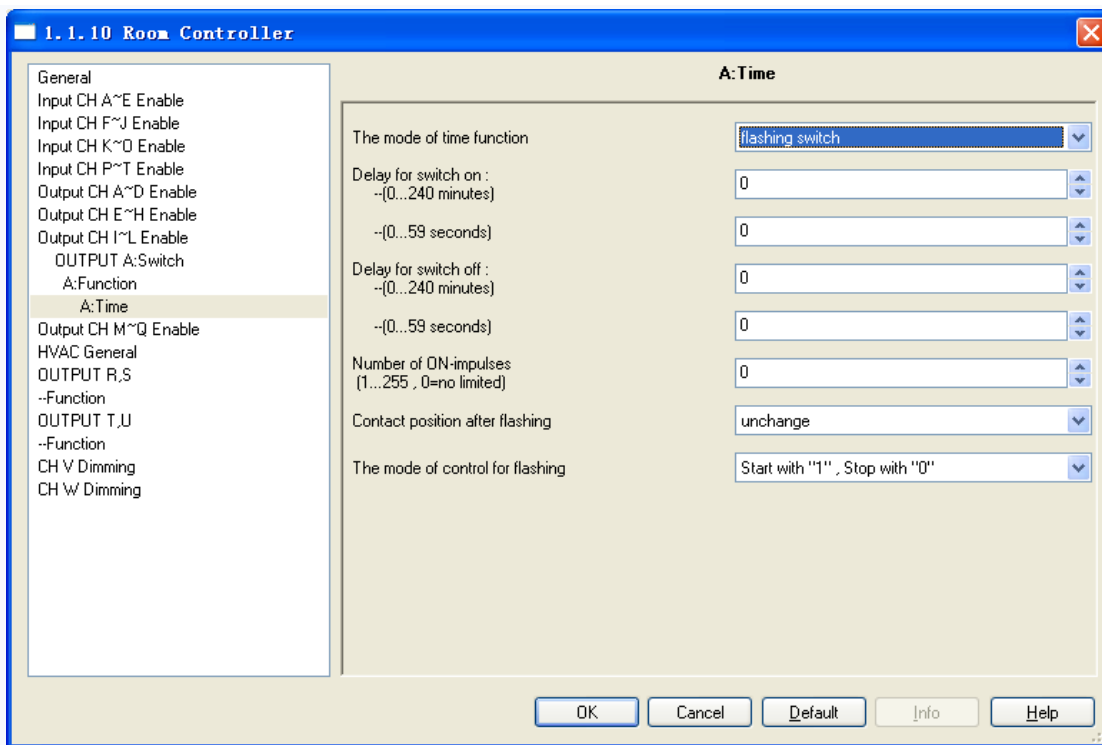

Fig. 5.13 parameter window “X: Time-flashing switch”

The flashing switch can be started via the object “switch, X”, as shown in fig. 5.10. It is able to set the flashing time in “Delay for switch on” or “Delay for switch off”, which will restart the flashing when receiving the relevant telegram, and define the contact position after flashing.

Parameter “Delay for switch ON: Min. (0...240), Sec. (0...59)”

The parameter defines the duration time of switch on the output when flashing. Options:

0...240 minutes
0...59 seconds

Note: it will not be executed unless the time is lower than the relay threshold switch frequency. Since there will be not sufficient energy to do it because of the frequent relay switching, and it may cause the time delay. The

same situation will happen after the bus voltage recovery.

Parameter “Delay for switch off: Min. (0...240), Sec. (0...59)”

The parameter defines the duration time of switch off the output when flashing. Options:

0...240 minutes

0...59 seconds

Note: it will not be executed unless the time is lower than the relay threshold switch frequency. Since there will be not sufficient energy to do it because of the frequent relay switching, and it may cause the time delay. The same situation will happen after the bus voltage recovery.

Parameter “Number of ON-impulses (1...255, 0=no limited)”

This parameter sets the flashing times. 0 means no limited. A flashing includes an on and an off actions.

Options: 0...255

Parameter “Contact position after flashing”

This parameter defines the relay contact position after flashing. Options:

Unchanged

Open

Close

Parameter “The mode of control for flashing”

The parameter is used to select the control mode of the flashing output. Options:

Start with “1”, stop with “0”

Start with “0”, stop with “1”

Start with “1/0”, can not be stopped

It will start flashing with value “1” when selecting “star with “1”, stop with “0” ”; it will stop flashing with “0”.

The stop position is defined via last parameter.

It will start flashing with value “0” when selecting “star with “0”, stop with “1” ”; it will stop flashing with “1”.

The stop position is defined via last parameter.

It will start flashing with either “1” or “0” when selecting “star with “1/0”, can not be stopped”; Under this circumstance it cannot terminate the flashing by value until operation over or it is blocked by other operation.

5.3.3.3 Selection “Staircase lighting”

The parameter window of the staircase lighting function in Fig. 5.14 will be visible when selecting “Staircase lighting” in the parameter “The mode of time function”.

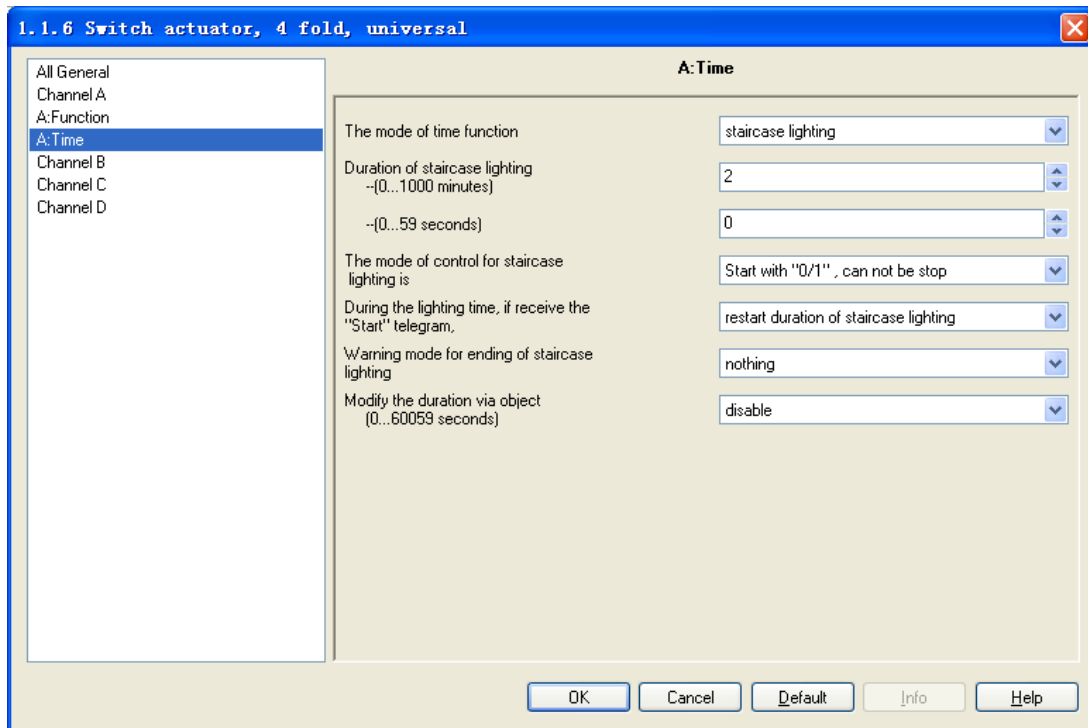

Fig. 5.14 parameter window “X: Time-staircase lighting”

The staircase lighting can be started via the object “switch, X”, as shown in fig. 5.10. The value that switches on the staircase lighting can be set via a parameter. The duration time of the lighting on is also set via a parameter. After the time the lighting will be switched off immediately.

Parameter “Duration of staircase lighting--(0...1000 minutes) -- (0...59 second)”

This parameter describes the duration time when switching on the staircase lighting. Options:

- 0...1000 minutes*
- 0...59 seconds*

Parameter “The mode of control for Staircase lighting is”

This parameter defines the control mode of the staircase lighting. Options:

- Start with “1”, stop with “0”*
- Start with “1”, no action with “0”*
- Start with “0/1”, cannot be stopped*
- Start with “1”, Off with “0”*

When selecting “Start with “1”, stop with “0””, it will switch on the staircase lights with the value “1”; it will stop the time counting operation with “0” and don’t change the contact position until changed by other operations.

When selecting “Start with “1”, no action with “0””, it will switch on the staircase lights with the value “1” and no reaction with “0”.

When selecting “Start with “0/1”, cannot be stopped”, it will switch on the staircase lights either with “0” or “1” but cannot stop it until the duration time finished or changed by other operation.

When selecting “Start with ‘1’, off with ‘0’”, it will switch on the staircase lights with the value “1”, and off with “0”.

Parameter “During the lighting time, if receive the ‘start’ telegram”

Options: *restart duration of staircase lighting*
Ignored the “switch on” telegram

If selecting “restart duration of staircase lighting”, if the staircase lighting is started again during the duration time, the duration time will be restart. While it will ignore the control value during the duration time with “Ignored the “switch on” telegram”.

5.3.4 Parameter window “X: Logic”

It will show up Fig. 5.15 when selecting “enable” in “Function of “logic” for switch is” in Fig. 5.11.

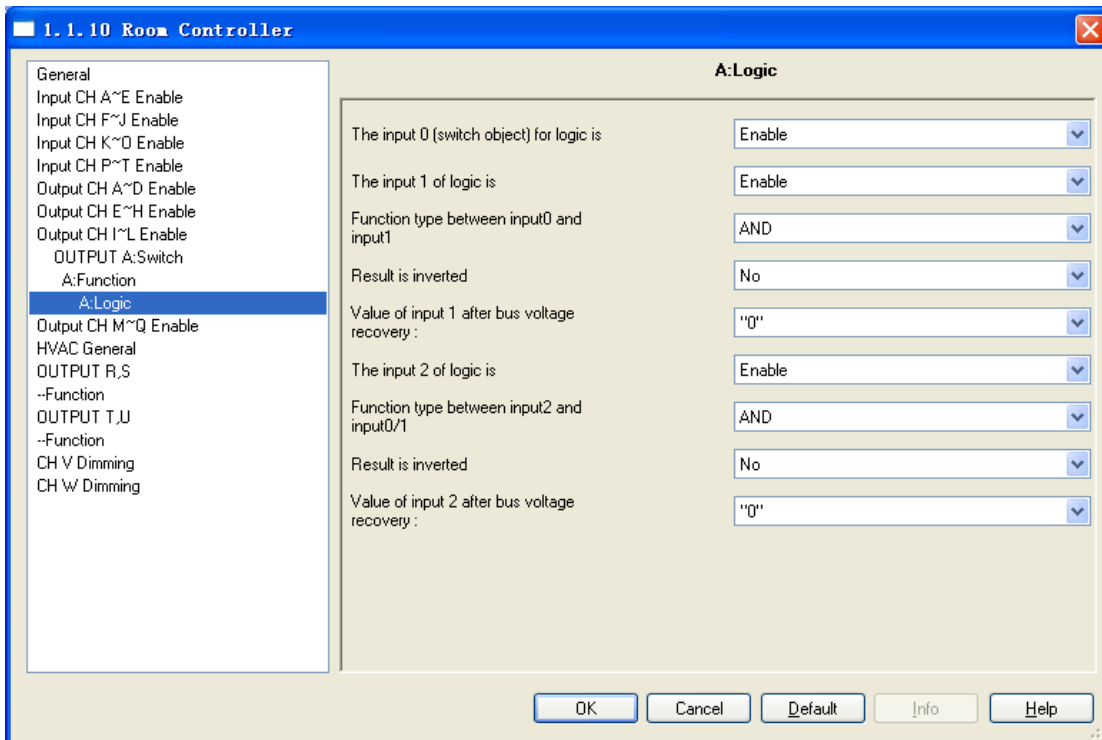

Fig. 5.15 parameter window “X: Logic”

There are 2 logic communication objects to decide the status of each output, which are related to the “Switch, X”, as shown in fig. 5.10

It will re-operate when receiving a new object value as the final output status (close the contact with “1”, open it with “0”). The values of the communication object “Input 1 of logic” makes logic operation with “Switch, X” firstly, and then the result after that will makes operations with the value of “Input 2 of logic”. This operation will ignore the objects which are unable, and continue to the next step with the ones who are enabled.

Parameter “The input 0 (switch object) for logic is”

This parameter is used to enable the function of logic operation of “input 0”, whose values are wrote by the object “Switch, X”. Options:

- Disable*
- Enable*

In the both cases of input 0 enabled and not enabled, there are not different parameters. All parameters of logic function have described in the following. If input0 is disabled, the parameters will be less. If there are not certain parameters in the case, then it is also not available with the function of these parameters.

Parameter “The input x of Logical” (x = 1, 2)”

This parameter is used to enable input1 and input 2. If enable, their communication objects “Input 1 of logic” and “Input 2 of logic” will be also visible. Options:

- Disable*
- Enable*

Parameter “Function type between input 0 and input 1/(input 2 and input 0/1)”

This parameter introduces the logical relationship of the logic operation, providing 3 standard logical operations (AND, OR, XOR) and a gate function.

Explanation of gate function: it will use the next logic value as the enable mark of the previous logic. If the enable mark of the next logic is “1”, that means it is able to use the previous logic value as the operation result. E.g. the value of input 1 is 1, that means the value of input 0 can be used as the operation result; if the value of input 2 is 1, that means the operation value of input 0/1 can be used as the result. Options:

- AND*
- OR*
- XOR*
- Gate function*

Below result of logic operation is possible:

Logic function	Object values					Description
	Input0 (Switch)	Input1	Result of Input0/1	Input2	Output	
AND	0	0	0	0	0	The result is 1 if both input values are 1.
	0	1	0	1	0	
	1	0	0	0	0	
	1	1	1	1	1	
OR	0	0	0	0	0	The result is 1 if one of both input values is 1.
	0	1	1	1	1	
	1	0	1	0	1	
	1	1	1	1	1	

XOR	0	0	0	0	0	The result is 1 if both input values have a different value.
	0	1	1	1	0	
	1	0	1	0	1	
	1	1	0	1	1	
GATE	0	Closed	0	Closed	0	The input0 of value is only allowed through if the GATE (input 1 and input 2) is open. Otherwise the input0 of value is ignored.
	0	Open		Open		
	1	Closed	1	Closed	1	
	1	Open		Open		

Note:

1. The values of the communication object "Input 1" makes logic operation with "Switch, X" firstly, and then the result will makes operations with the value of "Input 2", and the final operation result as the final output (close the contact with "1", open it with "0").
2. If an input is not enabled, this input is ignored.
3. If logic result needs to be negated, the first negated, then the next step.
4. GATE function is available only if input0 is enabled. The signal can be passed if the GATE is open, otherwise it is ignored. For example, the input 0 of value is ignored when the GATE of input1 is closed, and the output is directly determined by the input2 (input2 is not GATE).

Parameter "Result is inverted"

This parameter defines whether negate the logical operation results. Negate it with "yes", don't with "no".

Options:

- No*
- Yes*

Parameter "Value of input 1 after bus voltage recovery"

This parameter is visible if input 0 is disabled, which defines the default value of the object "Input 1 of logic" after bus voltage recovery. Options:

- 0*
- 1*
- Value before power off*

The value will be the one before power off after bus voltage recovery when selecting "value before power off". Note that the program can not be treated as a power off, so there is no need to focus on the value before programming, but the value before the bus power off.

Parameter "Value of input 2 after bus voltage recovery"

This parameter defines the default value of the object "Input 2 of logic 2" after bus voltage recovery. Options:

- 0*
- 1*
- Unchanged*

The default logic value is 0 when selecting “Unchanged”.

5.3.5 Parameter window “X: Scene”

The parameter window shown in Fig. 5.6 will burst out when selecting “enable” in “Function of “scene” for switch is” in Fig. 5.11. Here can set 8 scenes.

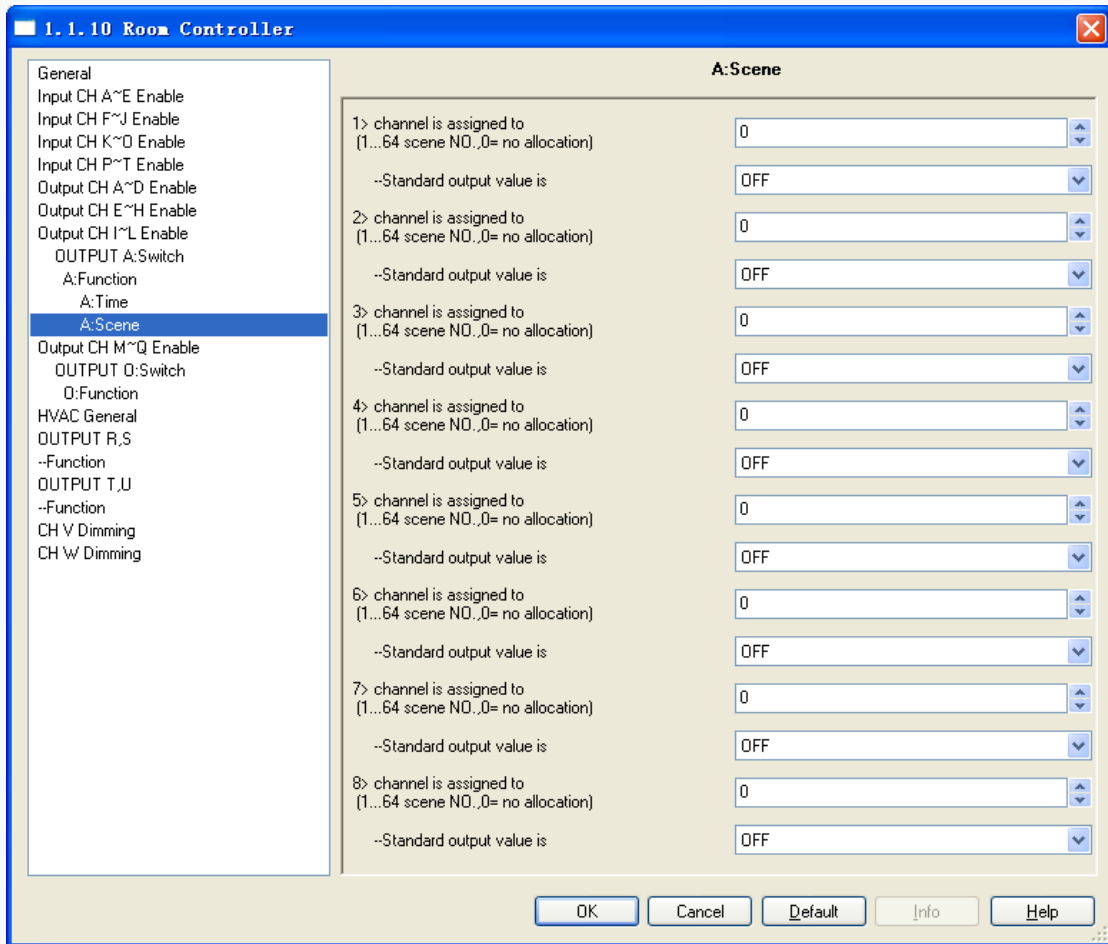

Fig. 5.16 parameter window “X:Scene”

Parameter “channel is assigned to (1...64 scene NO., 0= no allocation)”

It is able to allocate 64 different scene numbers to every output. There are 8 various scenes can be set per output.

Options: *Scene 1... Scene 64, 0=no allocation*

Note: *1-64 in the parameter setup corresponds to the scene number 0-63 received by the communication object “Scene”. If a scene is modified, the new scene will be stored when power off. After bus voltage recovery, it can be recalled again.*

Parameter “--Standard output value is”

This parameter defines the switch output status when recall the scene. Options:

- ON
- OFF

5.3.6 Parameter window “X: Forced

The window of the function “forced” in Fig. 5.17 will be visible with “enable” in the parameter “Function of “forced” for switch is” in Fig. 5.11.

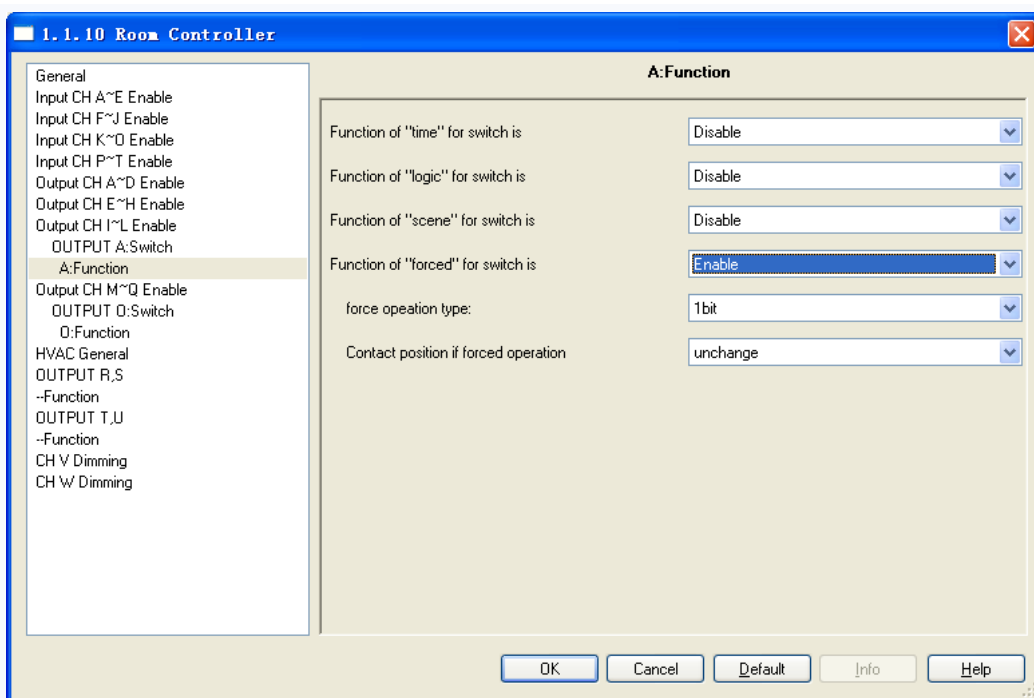

Fig. 5.17 parameter window “X: Forced”

This function will be used in some special situation such as emergency, and are activated by the object “Forced output,X” with the highest priority in the system, which means only “forced operation” are valid in this case.

Parameter “Force operation type”

The parameter defines the control type of force operation. Options:

- 1bit
- 2bit

If selecting “1bit”, object “Forced output, X” receives telegram “1” to activate force operation, telegram “0” to cancel the force operation.

If selecting “2bit”, when the object “Forced output,X” receives a telegram value, the action as follow:

Value of object "Forced output,X"	Action
00b(0),01b(1)	Cancel force operation, other operation can be performed.
10b(2)	Force switch off
11b(3)	Force switch on

When cancel the forced operation, the position of relay contact is unchanged.

Parameter "Contact position if forced operation"

The parameter is visible if the option "1bit" is selected via last parameter, which defines the contact position of force operation. Option:

Unchanged

Open

Close

If selecting "unchanged", the current operating or the current contact status will be kept. For example, flashing switch before force operation, the flashing switch is still performed until it over. If the force operation is cancelled during the flashing switch, then the flashing switch will be also interrupt.

The forced operation has the highest priority, and all the other operations are ignored during the forced operation. If telegram of the time function is received during the forced operation, the time function will be performed after cancel the forced operation.

5.4 Shutter outputs (M~N)

There are 2 outputs. Each output can be set separately, and parameters and objects which are assigned to each output are the same. Using one of outputs as an example described.

5.4.1 Parameter window "Output CH X enable"

Parameter window "Output CH X enable" can be shown in fig.5.18. Here set whether enable the output X (X=M,N) of Shutter actuator.

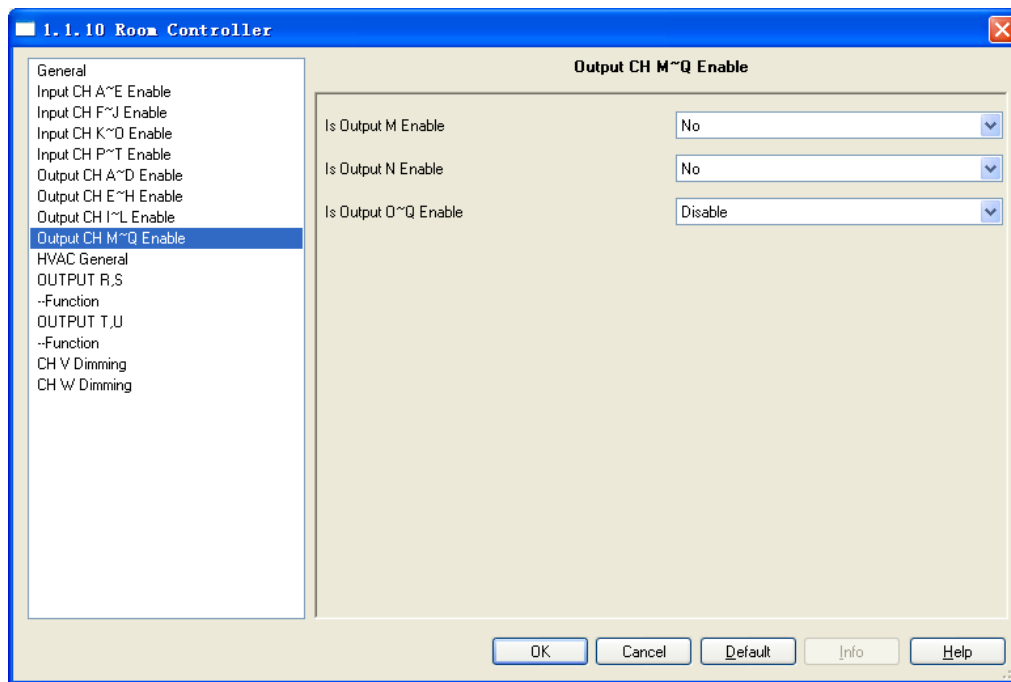

Fig.5.18 parameter window “Output CH M~N enable”

5.4.2 Parameter window “Output CH X- Shutter”

Parameter window “Shutter” can be shown in fig.5.20.

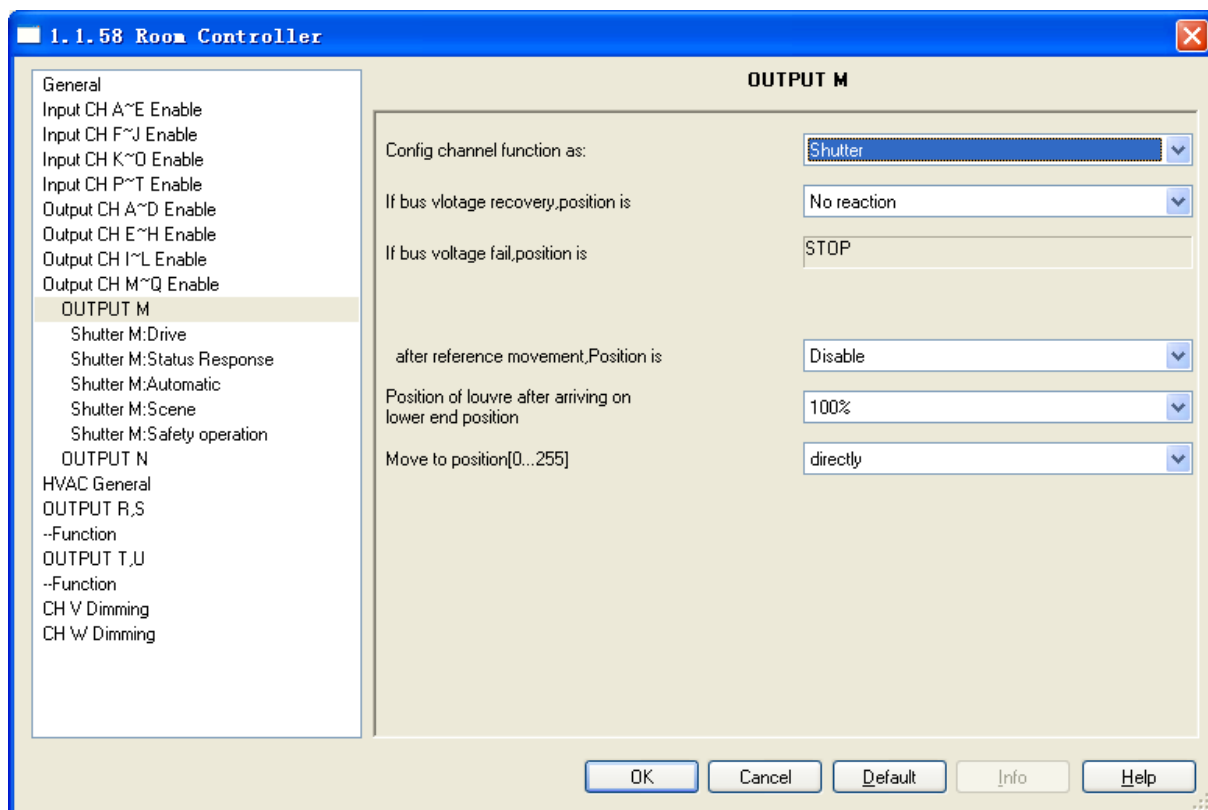

Fig. 5.20 parameter window “Shutter”

Parameter “Config channel function as:”

This parameter is used to define the output mode. Different output modes have different parameters and communications. Options:

- No function*
- Shutter*
- Blinds*

If selecting “*No function*”, the output is disabled.

If selecting “*Shutter*”, the output is for the Shutter operation mode, which can operate the curtain with louvres.

If selecting “*Blind*”, the output is similar with the Shutter operation mode, except that it cannot adjust louvres.

The section 5.3 details the parameters and communication objects for the “Shutter” mode.

Parameter “If bus voltage recovery, position is”

The parameter is used for setting the behavior of the output on bus voltage recovery. Options:

- No reaction*
- Up*
- Down*

If the option “*no reaction*” is set, the output contacts remain in their current position. If the option “*up*” is set,

the Shutter is moved to the top after bus voltage recovery. If the option “*down*” is set, the Shutter is moved to the bottom after bus voltage recovery.

All the communication objects adopt the value “0” after programming or bus voltage recovery.

Note: If the option “no reaction” has been set the position after programming or bus voltage recovery, the Shutter actuator does not detect the current position of the Shutter. The communication objects “Shutter position [0...100%]” and “Louvre position [0...100%]” have the default value “130” and are not sent on the bus.

If after programming or bus voltage recovery a defined position of the Shutter is required for the first time, it is first of all raised to the top or dropped to the bottom (toward near the target location moving) to determine the current position and then into the target position. Only the Shutter finish a full running can confirm position.

Parameter “If bus voltage fail, position is”

The parameter note that the shutter is stop running and the position status is not saved when the bus voltage fail.

Parameter “After reference movement, Position is”

This parameter specifies how the Shutter actuator behaves after a reference movement. Options:

Disable

No reaction

Move to save position

If the option “*disable*” is selected, the reference movement is deactivated, other option is selected, and the communication object “reference movement” appears. If the option “*no reaction*” is selected, the object receives a telegram “0”, the Shutter is moved to the top; the object receives a telegram “1”, the Shutter is moved to the bottom. If the option “*move to save position*” is selected, the object receives a telegram “0”, the Shutter is moved to the top, then back to its original position; the object receives a telegram “1”, the Shutter is moved to the bottom, then back to its original position.

The Shutter actuator continually determines the current position of the Shutter as well as the angle position of the louvre using the duration of individual movements. Over longer periods, slight inaccuracies may occur when determining the position due to temperature variations and ageing processes. Therefore the Shutter actuator uses the upper and lower limit positions to clearly define the current position of the Shutter. Each time that the Shutter is in the upper or lower limit position, the position is updated in the memory of the Shutter actuator.

If the limit positions have not been reached during normal operation, a reference movement can be triggered via a bus telegram to move the Shutter right to the top or right to the bottom. Depending on the parameter settings,

the Shutter either remains in the reference position after the reference movement or moves back into the saved position.

Parameter “position of louvre after arriving on lower end position”

The parameter can set the slat positions of louvre after the lower end position is reached. Options:

0%/10%/.../90%/100%

If select “100%”, after the shutter is moved to the lower end position, the slats are closed;

If select “40%”, when the object “Shutter UP/DOWN” receives a telegram “1”, the shutter will move to the lower end position, then the slat positions are adjusted to 40%.

Note: the parameter relates to the reaction of the shutter, if the motion has been triggered via the communication object “Shutter UP/DOWN” or by the Automatic function, and the reaction after bus voltage recovery. Other trigger ways is not affected for the parameter.

5.4.2.1 Parameter window “Shutter: Drive”

Parameter window “Shutter: Drive” is shown in fig. 5.21. Here set the relevant parameters with the Shutter drive. The current position of the Shutter can be usually calculated based on the total move time. The duration of louvre adjustment and total move time of louvre can calculate the current position of louvre. The technical data and running time are different for different Shutter. It is therefore important to know its technical data and running time before using the Shutter. It is the only way that the relevant parameters can be set precisely for the Shutter actuator.

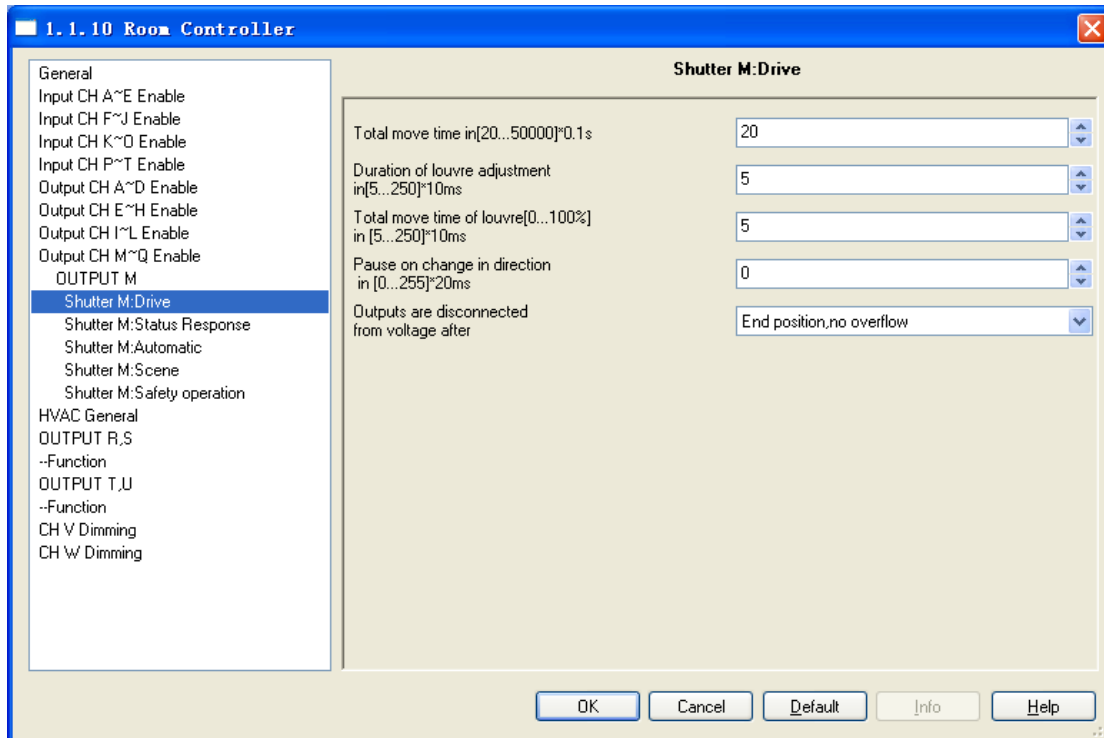
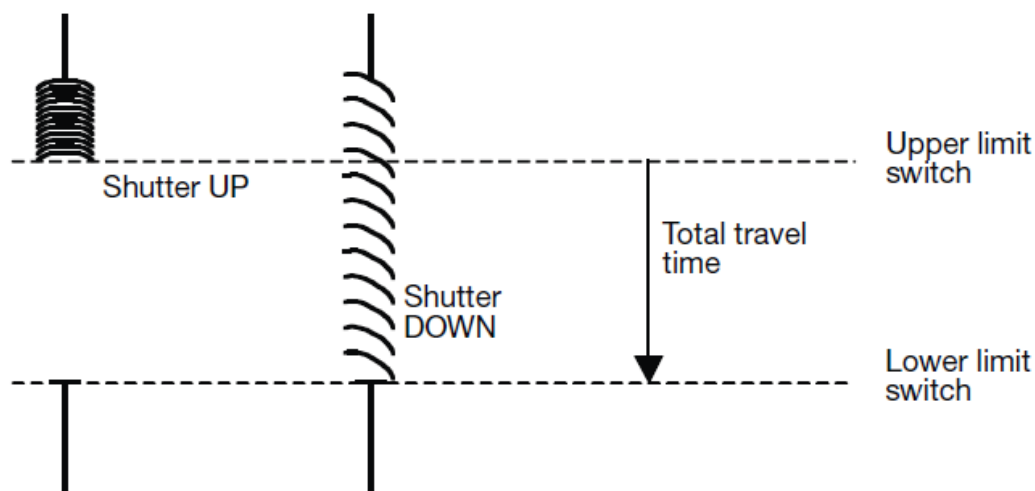

Fig. 5.21 parameter window “Shutter:Drive”

Parameter “Total move time in [20...50000]*0.1s”

The parameter is used for setting the total move time in seconds.

The total move time is the period that the Shutter requires to travel from the upper limit position to the lower limit position (see following Diagram). If the Shutter actuator receives an UP or DOWN movement command, the corresponding output is switched and the Shutter is moved in this direction until the Shutter actuator receives a STOP command, or until the upper or lower limit position has been reached and then the motor is switched off via the limit switch. If the Shutter is switch off via the limit switch, the corresponding output contact of the Shutter actuator remains closed until the set total move time has elapsed plus the parameterized overflow time (see parameter “outputs are disconnected from voltage after” description), only then the output contact reverts to neutral position.



Note: The current position of the Shutter during operation can also be determined with the help of the total move time. It is therefore important to measure and set the total move time as accurately as possible, particularly if the functions “Move to position via a 1byte value” and “Status response” are used. Only then is it possible to calculate the current position of the Shutter precisely.

Parameter “duration of louvre adjustments [10…250]*10ms”

The parameter is used for setting the duration of louvre adjustment in milliseconds. The shorter the time, the more precise angle adjustment of slats.

After an upward movement of the Shutter, the louvres normally are open (horizontal louvre position). If the Shutter is now lowered, the louvres are closed first of all (vertical louvre position) and the Shutter moves downwards. If the Shutter is now raised again, the louvres are opened again first (horizontal louvre position) and then raised. (See following Diagram)

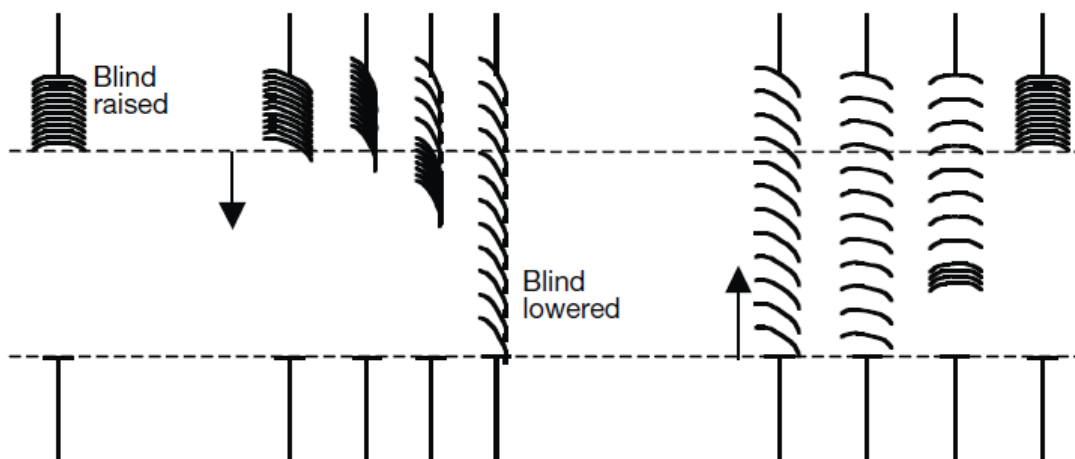

Parameter “Total move time of louvre [0…100%] in [5…250]*10ms”

The parameter is used for setting the total move time of louvre adjustments from fully closed to fully open. It determines the current position of the louvres during operation. It is therefore important to measure and set the total move time of louvre as accurately as possible, particularly if the functions “adjust to position via a 1byte value” and “Status response” are used. Only then is it possible to calculate the current position of the louvre precisely.

The parameter is used together with above parameter. The max. number of louvre adjustment that the louvres is adjusted from fully closed to fully open is divide the total move time of louvre by the duration of louvre adjustment.

Parameter “pause on change in direction in [0...255]*20ms”

The parameter is used for setting the pause on change in direction in milliseconds. The technical data supplied by the drive manufacturer must be taken into account, to enter a suitable value in the parameter. The function can prevent the motor to damage on change suddenly in direction, and extend the service life of the motor.

Parameter “outputs are disconnected from voltage after”

This parameter is used to set the output off delay time. Options:

- End position, no overflow*
- End position + 2% overflow*
- End position + 5% overflow*
- End position + 10% overflow*
- End position + 20% overflow*
- Total travel time + 10% overflow*

If selecting “*End position, no overflow*”, the output is disconnected from voltage without delay, i.e. when the total move time has elapsed, the output is disconnected immediately.

If selecting “*End position + 2%/.../20% overflow*”, when the Shutter reach the end position (completely up or completely down), the output is disconnected after a delay time (the delay time=2%/.../20%×the total move time). If the end position does not reach completely up or completely down, the output will be disconnected without delay. Other case is, after reached the end position the output also has a delay time, and then turned to move to the target location, i.e. just go to this end position, there will be delay.

If selecting “*Total travel time + 10% overflow*”, the time that the Shutter is moved from the top to the bottom is for the total move time plus the overflow time (the overflow time=10%×the total move time). When the time has elapsed, the output is disconnected immediately. Regardless of whether the Shutter reaches the top or the bottom, the time will affect the entire movement.

5.4.2.2 Parameter window “Shutter: Status response”

Parameter window “Shutter: Status response” is shown in fig. 5.22. Here set status response, to know and

query the current position of shutter and the current operation status etc.

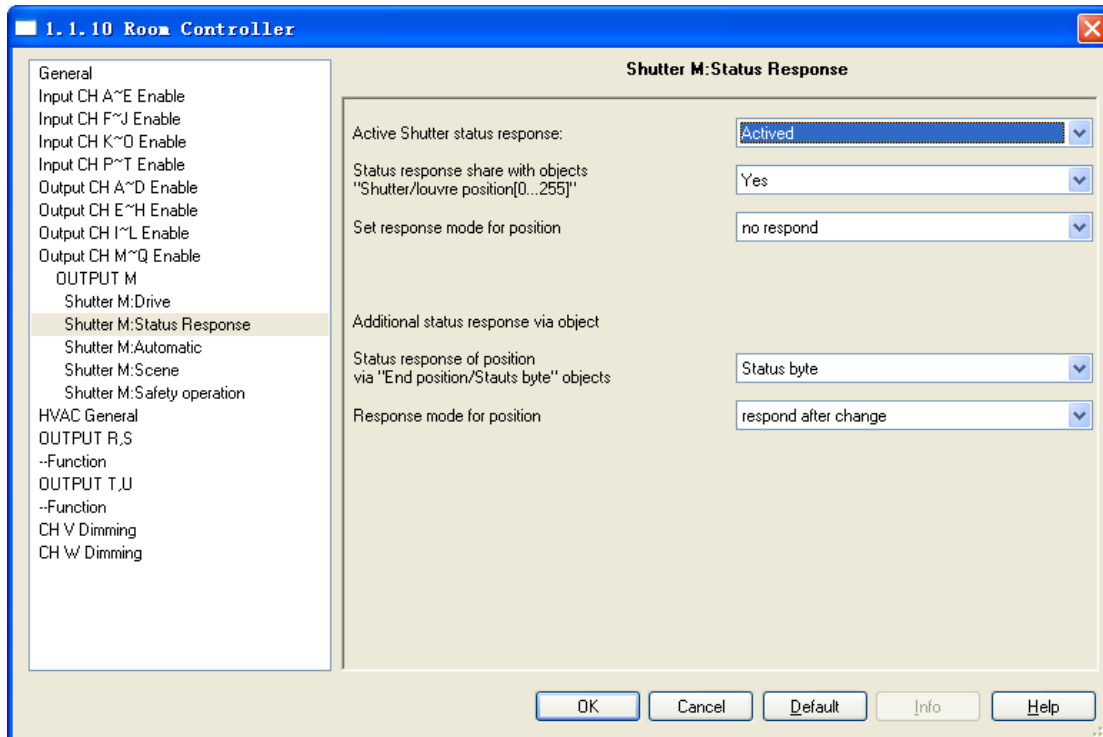

Fig.5.22 parameter window “Shutter:Status response”

Parameter “Active Shutter status response”

The parameter defines whether enable status response of shutter. Options:

- Activated*
- Deactivated*

If select “Activated”, the following parameters will be visible.

■ **Parameter “Status response share with objects ‘Shutter/ louvre position [0…255]’ ”**

The parameter defines whether the communication object “Shutter position [0…100%]/Louvre position [0…100%]” sends a status response. Options:

- Yes*
- No*

If select “Yes”, the following parameter “Set response mode for position” appears:

-- Parameter “Set response mode for position”

The parameter defines the response mode for shutter position. Options:

- Respond, after read only*
- Respond after change*

If select “Respond, after read only”, the status is sent after a request.

If select “Respond after change”, the status is sent after a change.

■ **Parameter “Status response of position via ‘End position/Status byte’ objects”**

The parameter defines whether the communication object “End position (Upper/Lower)/Status byte” sends a status response. Options:

- None*
- End position*
- Status byte*

If select “*none*”, there is no feedback.

If select “*End position*”, the communication objects “End position (Upper)” and “End position (Lower)” are enabled. These indicate that the shutter is in the upper or lower position (measured based on total movement time).

If select “*Status byte*”, the communication objects “Status byte” is enabled. The information is provided in coded format in a 1byte value, see table below:

Object “Status byte”								
Data bits	Bit7	Bit6	Bit5	Bit4	Bit3	Bit2	Bit1	Bit0
Functions	Not used	Not used	Safety 2	Safety 1	Automatic	Sun	Upper end position	Lower end position
Values	0	0	0:inactive 1:active	0:inactive 1:active	0:inactive 1:active	0:inactive 1:active	0:inactive 1:active	0:inactive 1:active
Note: Special coding for Bit1 and Bit0: 00—Shutter between upper and lower end position 01—lower end position 10—upper end position 11—Shutter position undefined								

-- **Parameter “Response mode for position”**

The parameter is visible if the above parameter “Status response of position via ‘End position/Status byte’ objects” is not “none”, which defines the response mode for end position or operation status. Options:

- No respond*
- Respond, after read only*
- Respond after change*

If select “*no respond*”, the status is no feedback;

If select “*Respond, after read only*”, the status is sent after a request;

If select “*Respond after change*”, the status is sent after a change.

5.4.2.3 Parameter window “Shutter: Automatic”

The parameter window “Shutter: Automatic” is shown in fig.5.23. Here can set the automatic sun protection operation. Depending on the strength of induction light for the brightness sensor, the Shutter actuator moves the shutter/blind into a set position. For example, the shutter/blind can be raised if the sun is very weak or is not shining on the window at all. As much light as possible is thereby let into the room. If there is blazing sun on the window, the shutter/blind can be lowered and the louvres can be adjusted to the extent that direct sunlight cannot penetrate the room. Meanwhile, the residual opening in the shutter lets in a sufficient level of diffuse light into the room.

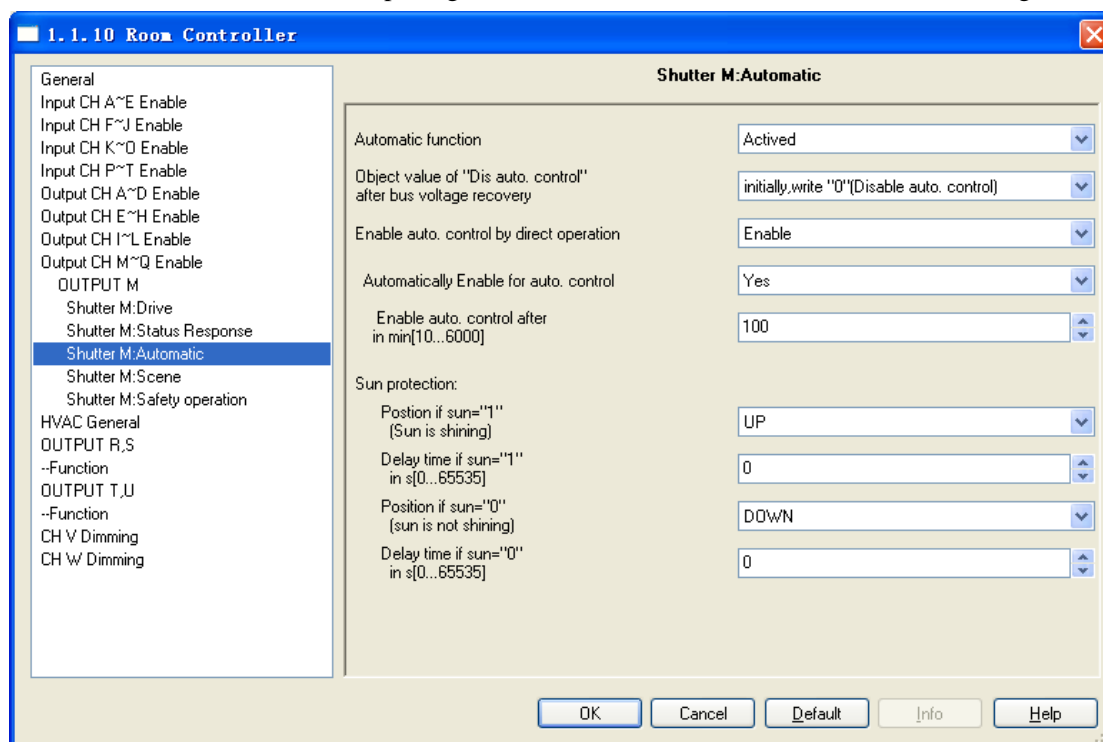

Fig. 5.23 parameter window “Shutter:Automatic”

Parameter “Automatic function”

The parameter is used to set whether the Auto. Control operation is activated, i.e. the Automatic sun protection function. Options:

- Activated*
- Deactivated*

If the option “activated” is selected, the following three parameters will be visible. The communication objects “Dis. Auto. Control”, “Sun operation”, “Sun: Shutter position [0...100%]” and “Sun: Louvre adj. [0...100%]” also will be visible.

When the object “Dis. Auto. Control” receives a telegram “1”, the Auto. Operation is activated. When the

object “Dis. Auto. Control” receives a telegram “0” or the user sends a direct movement command (e.g. UP/DOWN, move to position etc.), the Auto. Operation is deactivated. If the command is not belong to the direct movement command (e.g. store scene etc.), the Auto. Operation is still activated.

The priority of direct operation and automatic operation is the same, but they cannot occur at the same time.

Note: After the automatic operation is deactivated, only when the object “Dis. Auto. Control” receives a telegram “1” or the set time for the direct operation to automatic has elapsed (see parameter “Enable auto. Control after in min [10…6000]”), it can be activated again.

■ **Parameter “Object value of ‘Dis. auto. control’ after bus voltage recovery”**

The parameter defines the initial value of the communication object “Dis. Auto. Control” after bus voltage recovery. Options:

Initially, write “0” (disable auto. control)

Initially, write “1” (enable auto. control)

If select “Initially, write ‘0’”, the initial value is 0, indicate that the auto. Operation is deactivated after bus voltage recovery.

If select “Initially, write ‘1’”, the initial value is 1, indicate that the auto. Operation is activated after bus voltage recovery.

■ **Parameter “Automatically Enable for auto. control”**

The parameter defines whether the auto. Operation can be automatically reactivated after it has been deactivated for the direct operation or the object “Dis. Auto. Control”. Options:

No

Yes

This function is particularly suitable if no additional button is available for the activation or deactivation of automatic control.

Select “yes”, the following parameter appears:

-- **Parameter “Enable auto. Control after in min [10…6000]”**

Using the parameter, the duration for the automatic reactivation of the automatic Operation is defined. I.e. after the automatic operation has been deactivated for the direct operation or the object “Dis. Auto. Control”, it can be automatically reactivated when the set time has elapsed.

If the automatic operation is interrupted during the set time by a direct operation or object “En. / Dis. Auto. Control”, the time will re-timing.

Note: the safety operations have the higher priority. It is therefore the automatic operation can be not activated automatically if the safety operation is active. The duration time will be begun to time until the safety

operation is cancelled.

■ **Parameter “Sun protection:”**

-- **Parameter “Position if sun= ‘1’ (Sun is shining)”**

This parameter is used to set the position that the shutter is moved into when there is blazing sun, i.e. when the object “Sun operation” receives a telegram “1”, the shutter is moved into the position. Options:

No reaction

Up

Down

Stop

Receive 1 byte value

If the option “no reaction” is set, the output contacts remain in their current position when the object “Sun operation” receives a telegram “1”.

If the option “receive 1 byte value” is set, when the object “Sun operation” receives a telegram “1”, the position depending on the values that the objects “Sun: Louvre adj.[0...100%]” and “Sun: Shutter position [0...100%]” received. After programming or bus voltage recovery, the two objects values are uncertain, and then their values are “130” by default. Only when the two objects receive the values, the position is confirmed. In any operating status, the values that the two objects receive can be stored, including the safety operation of the higher priority.

-- **Parameter “Delay time if sun= ‘1’ in s [0...65535]”**

This parameter defines the delay time, i.e. the time that the Shutter actuator delays executing action when the object “Sun operation” received a telegram “1”. Mainly to prevent component damage or affect the motor life due to light frequent fluctuations lead to the Shutter actuator frequent action. Option: 0...65535 s

-- **Parameter “Position if sun= ‘0’ (Sun is not shining)”**

This parameter is similar with last parameter. The difference is that here defined the position that the shutter is moved into when the object “Sun operation” receives a telegram “0”.

-- **Parameter “Delay time if sun= ‘0’ in s [0...65535]”**

This parameter defines the delay time, i.e. the time that the Shutter actuator delays executing action when the object “Sun operation” received a telegram “0”. Mainly to prevent component damage or affect the motor life due to light frequent fluctuations lead to the Shutter actuator frequent action. Option: 0...65535 s

The follow is a simple automatic sun protection system:

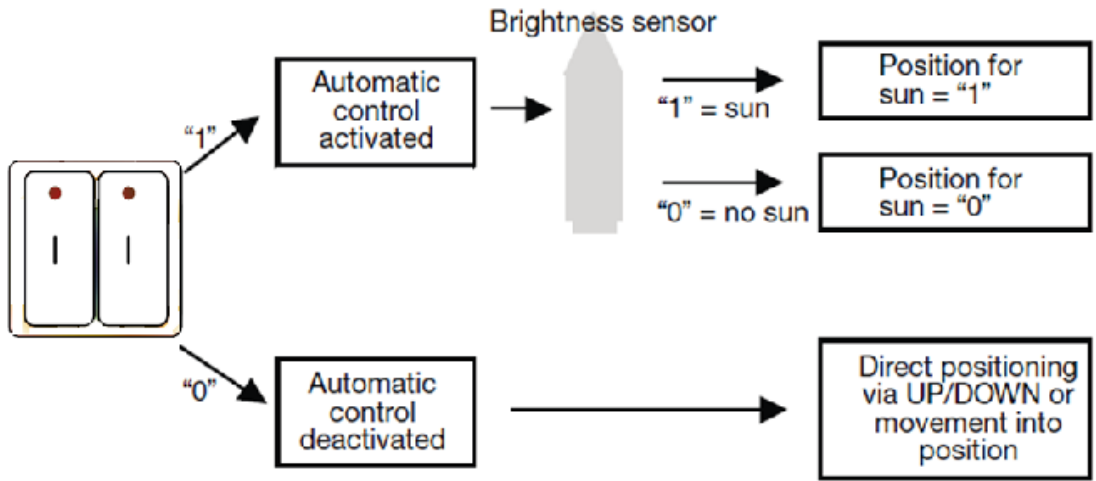

The brightness sensor is used to sense the light intensity. The push button can be connected with the universal interface or substitute for other switch sensor on the bus.

With the help of the second switch sensor, the user can specify whether to enable the automatic sun protection or to control the shutters/blinds manually. If the automatic sun protection is activated via a switch sensor, the shutter/blind moves automatically until either the automatic sun protection is deactivated via the same switch sensor or the user sends a direct movement command and the automatic function is thus also deactivated.

The Shutter actuator receives the information via the brightness sensor as to whether there is direct sunlight on the window. Once the delay period has elapsed, the Shutter actuator positions the shutter/blind according to the set Position for sun= “1” (sun) or Position for sun= “0” (no sun).

5.4.2.4 Parameter window “Shutter: Scene”

The parameter window “Shutter: Scene” is shown in fig.5.24. Here can set 8 scenes for per output.

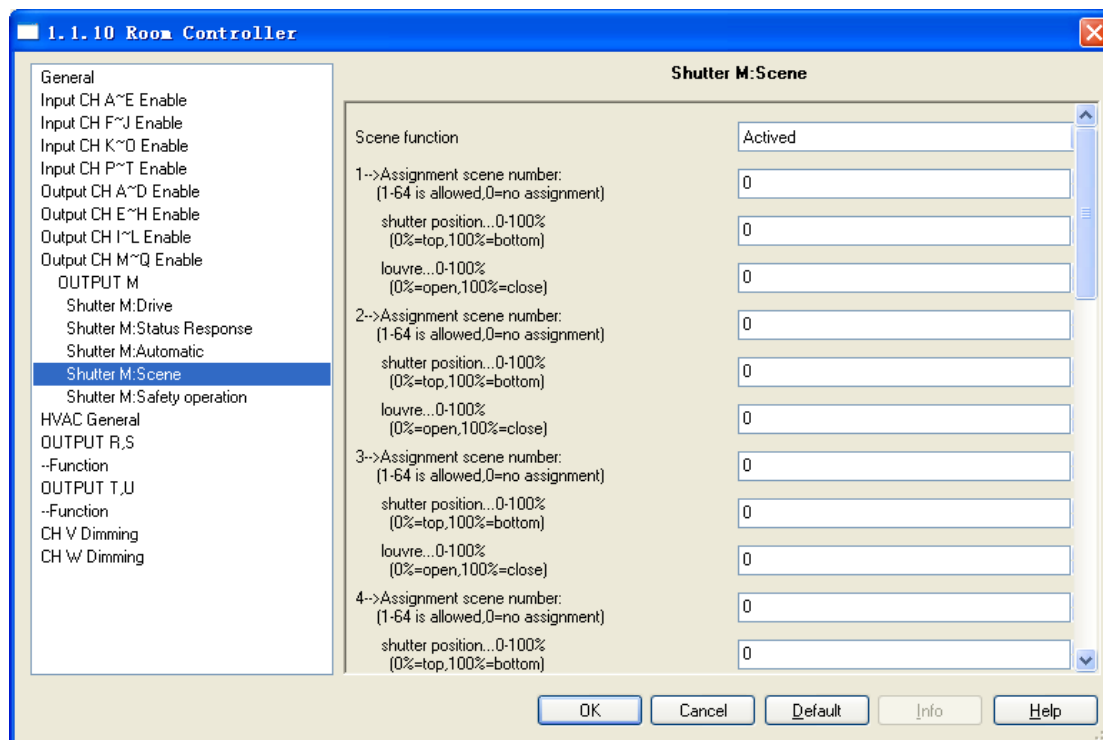

Fig. 5.24 parameter window “Shutter:Scene”

Parameter “Assignment scene NO. (1..64, 0= no allocation)”

There are 8 various scenes can be set for per output. It is able to allocate 64 different scene numbers for per scene. Options: *Scene 1... Scene 64, 0=no allocation*

Note: 1-64 in the parameter setting corresponds to the telegram 0-63 received. On bus voltage failure, the modified scene value is stored.

Parameter “--Shutter position 0...100% (0%=top, 100%=bottom)”

This parameter is used to set the preset position of Shutter for a scene: *0...100%,0%=top, 100%=bottom*

Parameter “--Louvre 0...100 % (0%=opened, 100%=closed)”

This parameter is used to set the preset position of louvres for a scene:*0...100%,0%=opened, 100%=closed*

5.4.2.5 Parameter window “Shutter: Safety operation”

The parameter window “Shutter: Safety operation” is shown in fig.5.25. Here can set safety operation of shutter actuator.

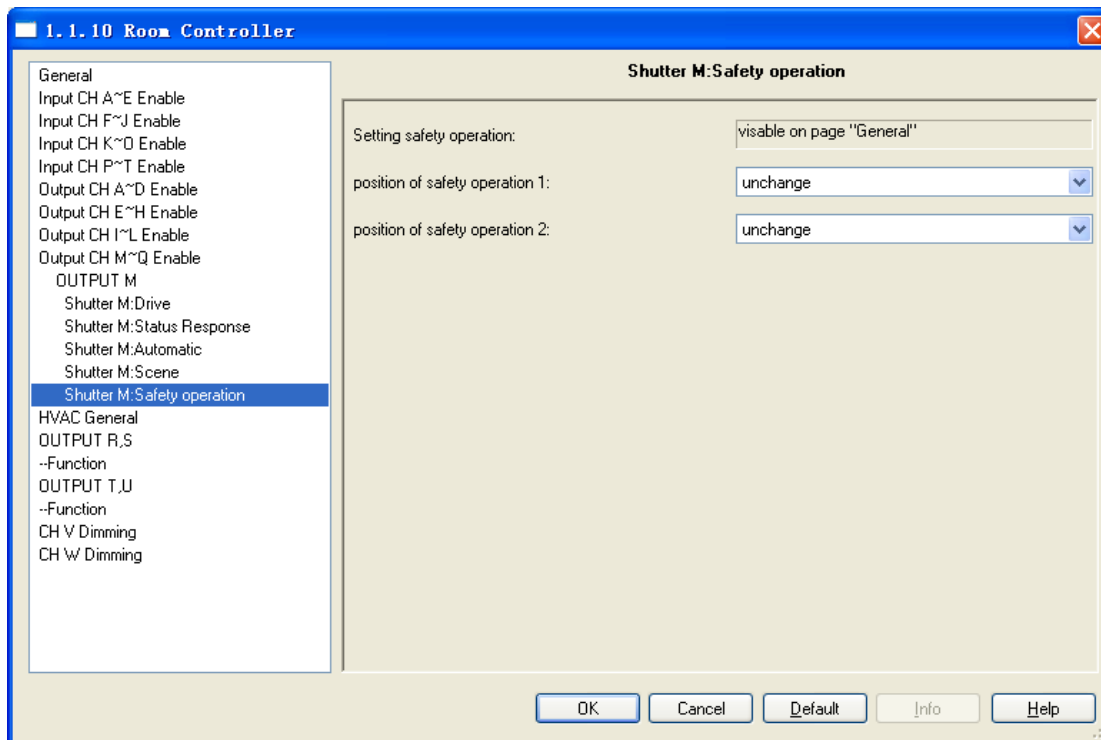

Fig. 5.25 parameter window “Shutter:Safety operation”

Enable “Safety operation” (x=1, 2) in the parameter window “General” , which define the action that the shutter should be carried out when the safety operation is triggered. There are 2 safety priorities for every output and also the “Safety operation 2” is prior to “Safety operation1” . It means when these 2 safety operation are triggered at the same time, the shutter position will follow the setup of “Safety operation 2” .

Parameter “position of safety operation 1/2”

It defines the shutter action after triggering “Safety operation x” (x=1, 2). Options:

- Unchanged*
- Up*
- Down*
- Stop*

5.4.3 Parameter window “Output CH X- Blind”

The “Blind” operation mode is similar with the “Shutter” operation mode in the parameters and the objects, and their function is also almost the same. The only difference is that there is no louvre adjustment function in the “Blind” operating mode.

“Shutter” and “Blind” difference as shown:

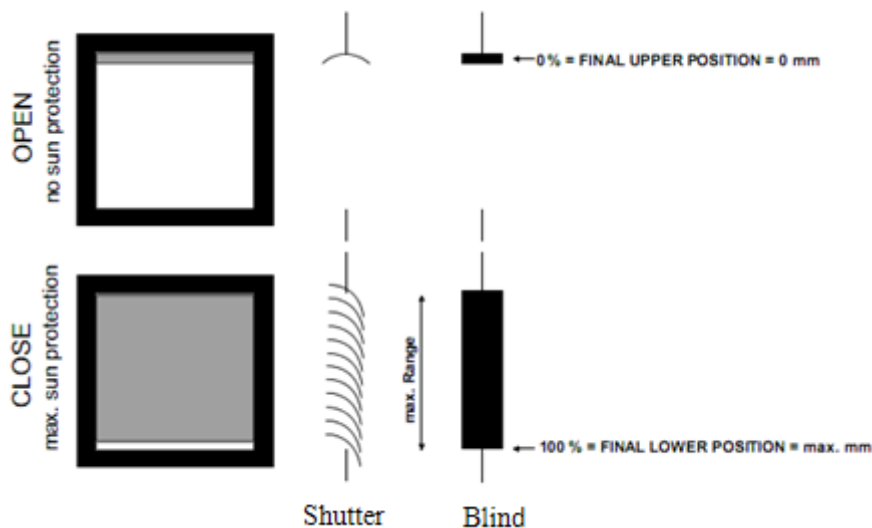

The functions described for the “Shutter” operating mode also apply to the “Blind” operating mode (with the exception of the louvre adjustment function).

5.5 Fan speed control (O~Q)

Fan coil controller includes fan speed control and HVAC system control, the fan speeds can be controlled by three outputs (O, P, and Q), the output O – lower fan speed, the output P – middle fan speed, the output Q – high fan speed. If these outputs are not as fan speeds control, they can be served as switch output and the functions of switch output are similar to the chapter 5.3 except for some functions deletion.

The chapter introduces the fan speed control and instruction of switch output functions deletion. The HVAC system control will be described in the follow chapter.

5.5.1 Parameter window “Output CH X enable”

The parameter window “Output CH X enable” is shown in fig.5.26. Here can set whether enable the fan speed control or switch output.

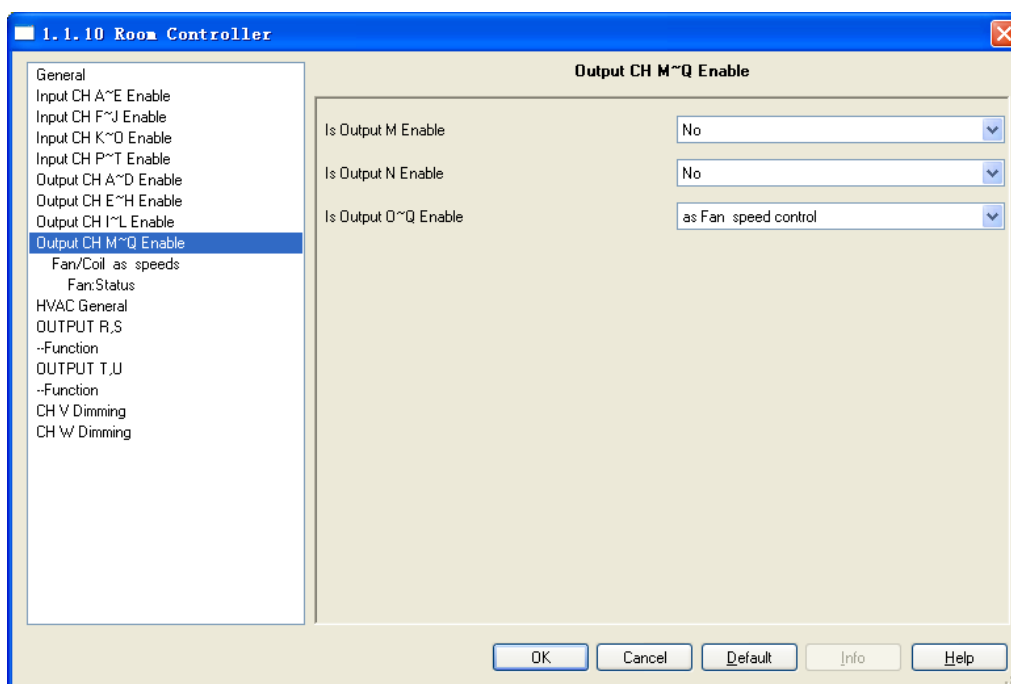

Fig. 5.26 parameter window “Output CH O~Q enable”

5.5.2 Parameter window “Fan-one level”

The parameter window of fan speed control is shown in fig.5.27. The fan speed of 1, 2 and 3, where 1 level is the output O, 2 levels are the output O and P, 3 levels are the output O, P, Q. The section will describe the parameter settings of one level fan speed, as follow:

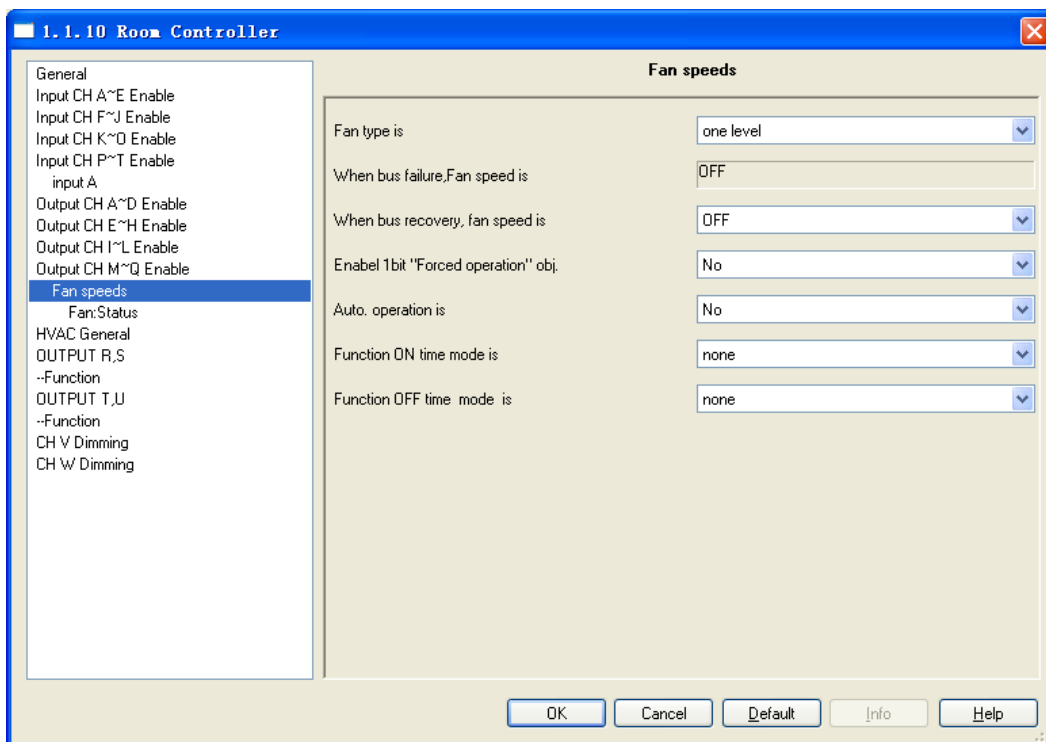

Fig. 5.27 parameter window “Fan-one level”

Parameter “Fan type is”

The fan type to be controlled is set with this parameter. Options:

- One level*
- Multi level*

If a fan with one speed is to be controlled, the option “*One level*” must be selected, and the output P and Q is no functions.

If a fan with up to three speeds is to be controlled, the option “*Multi level*” must be selected.

Parameter “When bus failure, Fan speed is”

The parameter defines that the behavior of the fan on bus voltage failure is off.

Parameter “When bus recovery, Fan speed is”

The behavior of the fan on bus voltage recovery is defined here. Options:

- OFF*
- ON*

With the “*OFF*”, the fan is switched off. If the switch off minimum time is set in follow parameter, the OFF will be remained for at least this time.

With the “*ON*”, the fan is switched on. If the switch on delay is set in follow parameter, the ON will be

executed when the delay has been elapsed.

Note: it is advisable to apply a bus voltage before connecting the fan in order to achieve a defined switch state of the fan. This eliminates the possibility of the destruction of the fan due to an incorrect contact setting.

Parameter “Enable 1bit ‘Force operation’ obj.”

Options:

No

Yes

With the “Yes”, a 1bit communication object “Fan Forced Operation” is enabled. The follow two parameters appear at the same time:

——**Parameter “Forced operation on object value is”**

Options:

0

1

1:the Forced operation is activated by a telegram value 1 of the object “Fan Forced Operation” and is cancelled by value 0.

0:the Forced operation is activated by a telegram value 0 of the object “Fan Forced Operation” and is cancelled by value 1.

——**Parameter “Behaviour on Force operation is”**

This parameter defines how the fan should respond with the Forecd operation. Options:

Unchanged

ON

OFF

With the “Unchanged”, the current speed is remained.

With the “ON”, the fan is switched on.

With the “OFF”, the fan is switched off.

The Forced operation has the highest priority, so its action is not influenced by the minimum time and switching delay of the follow parameter setting, rather than the forced action is performed immediately and other operations are ignored during Forced operation until the forced operation is cancelled.

Parameter “Auto. Operation is”

Options:

No

Yes

With the “Yes”, Automatic mode is enabled, an additional – Automatic operation parameter window (fig.5.28) appears. And the Auto. operation will be influenced by the follow two parameters “switching delay” and “minimum time”.

Parameter “Function ON time mode is”

The function time at fan ON is defined with this parameter. Options:

None

Switching delay

Minimum time

With the “None”, the time function is executed.

With the “Switching delay”, the fan is switched on using this delay.

With the “minimum time”, the fan remains ON for at least this time.

With option switching delay the following parameter appears:

—Parameter “ON time is [1...65535]*0.1s”

The fan is switched on using this delay. Option: 1...65535

With option minimum time the following parameter appears:

—Parameter “ON time is [1...65535]* 1s”

The fan remains ON for at least this time. Option: 1...65535

Parameter “Function OFF time mode is”

The function time at fan OFF is defined with this parameter. Options:

None

Switching delay

Minimum time

With the “None”, the time function is executed.

With the “Switching delay”, the fan is switched off using this delay.

With the “minimum time”, the fan remains OFF for at least this time.

With option switching delay the following parameter appears:

—Parameter “OFF time is [1...65535]*0.1s”

The fan is switched off using this delay. Option: 1...65535

With option minimum time the following parameter appears:

—Parameter “OFF time is [1...65535]* 1s”

The fan remains OFF for at least this time. Option: 1...65535

5.5.2.1 Parameter window “Fan: Auto. Operation”

This parameter window (fig.5.28) is visible if in fig. 5.27 the option yes has been selected in the parameter “Auto. Operation is”. Here set the auto. Operation of one level fan, the threshold values for switchover of the fan ON/OFF is defined. If the control value is greater than or equal to the threshold value, the fan is ON; if the control value is lower than the threshold value, the fan is OFF. You can also set a hysteresis value. The control value is received via the object “HVAC-General HEAT/COOL” or “HVAC-General COOL”. Furthermore, the 4 limitations can also be enabled.

The priority of direct operation and automatic operation is the same, but they cannot occur at the same time. That is, in the case that Auto. Operation has been activated, if there is direct operation, the Auto. Operation will be exited automatically, and it can be activated again by the object “Fan Automatic ON/OFF”. The forced operation can also make the Auto. Operation exit, but it has higher priority.

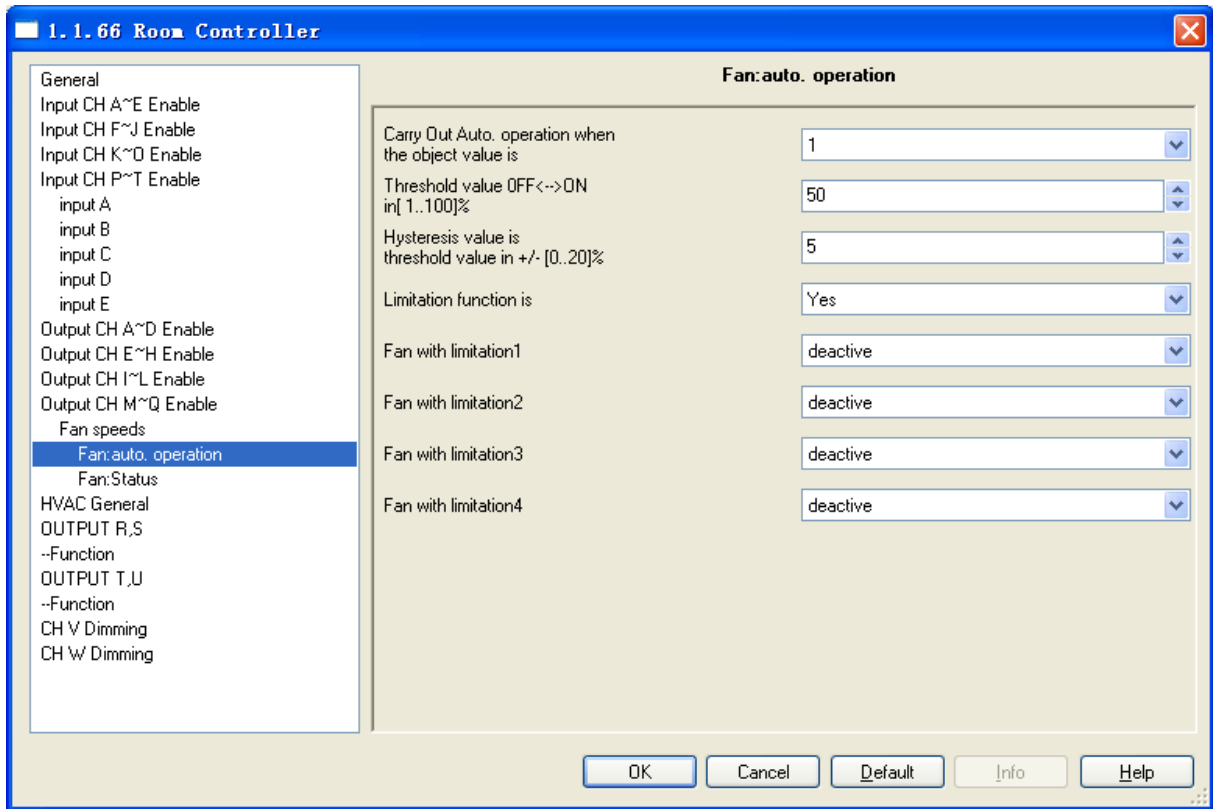

Fig. 5.28 parameter window “Fan-one level:Auto. operation”

Parameter “Carry out Auto. Operation when the object value is”

This parameter defines how to react to a telegram value of the communication object “Fan Automatic ON/OFF”. Options:

- 0
- 1

1: Automatic is activated by a telegram with value 1 and inactive by value 0.
 0: Automatic is activated by a telegram with value 0 and inactive by value 1.

Parameter “Threshold value OFF<->ON in [1…100] %”

Here the threshold value, at which switch on occurs, is defined. Options: 1...100%

If the control value of the communication object “HVAC-General HEAT/COOL”, “HVAC-General HEAT” or “HVAC-General COOL” is greater than or equal to the parameterized threshold value, it is switched on. If the value is less, it is switched off.

Parameter “Hysteresis value is threshold value in +/- [0…20] %”

Here a hysteresis value is set, at which switchover to the fan switch occurs. Using hysteresis, a continuous

switching of the fan around the threshold value with the control value deviating can be avoided. Options: 0...20%

The setting 0 causes immediate switching without hysteresis.

Assuming the hysteresis value of 5% and the threshold value is 50%, then the upper threshold value will be 55% (the threshold value + the hysteresis value), the lower threshold value will be 45% (the threshold value - the hysteresis value), then when the control value is between 45% and 55%, it will not cause the operation of the fan, only less than 45% is off the fan, and greater than 55% is on the fan. As shown below:

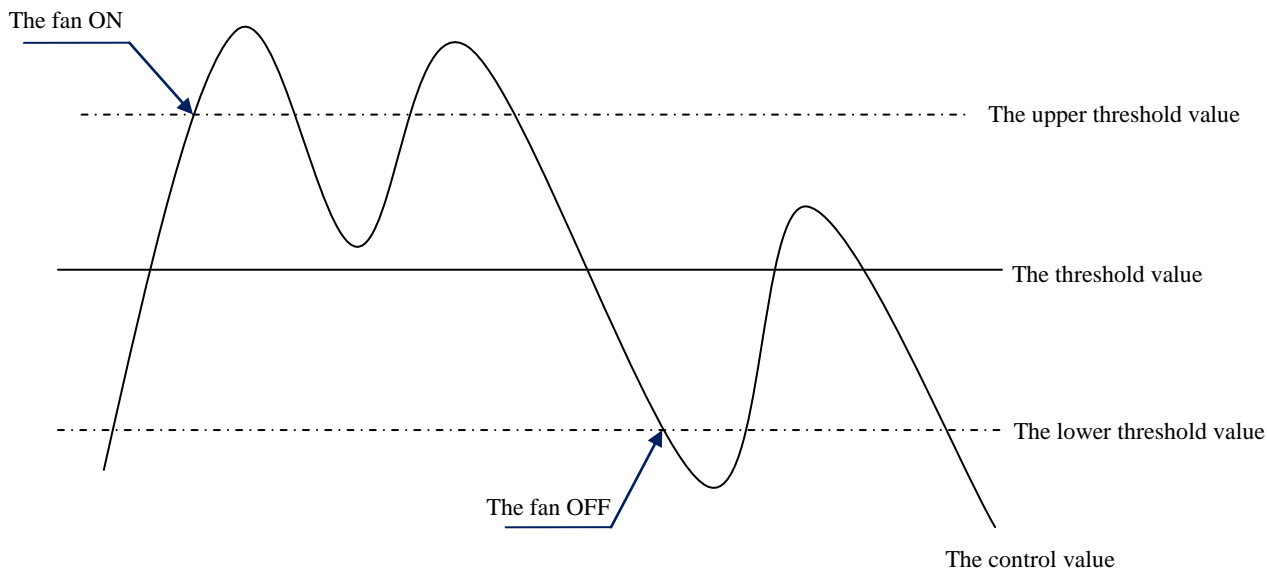

Parameter “Limitation function is”

The parameter set the limitation function of the Auto. Operation. Options:

- Yes
- No

With the “yes”, the following parameters appear, and 4 communication objects for limitation of the fan switching are enabled.

The four limitations can be used for example for the control of various operation modes such as:

- Limitation 1: e.g. for frost/heat protection
- Limitation 2: e.g. for comfort operation
- Limitation 3: e.g. for night shutdown
- Limitation 4: e.g. for standby operation

In normal cases, the thermostat takes these operating modes into account in its control variable for the room

controller.

The sequence of the displayed parameters corresponds with their priorities, i.e. the parameter with the highest priority has limitation 1 followed by limitation 2, 3 and 4. So the highest priority is assigned to limitation 1, e.g. Frost/Heat protection; the lowest priority is assigned to limitation 4, e.g. standby operation.

The limitation is activated if a telegram with the value 1 is received on the limitation object. The limitation is deactivated if a telegram with the value 0 is received on the limitation object.

The direct operation and the forced operation can end the Auto. Operation, but the limitations status can be maintained, it will affect the Auto. Operation again when the Auto. Operation is activated again. And even if the limitations can be also activated during the forced operation, but they only affect the Auto. Operation.

If a limitation is activated during the Auto. Operation, the switching of the fan is switchover to the parameterized status regardless of the control value. For example, a limit is set to “ON”, the fan is only switched on when the limit is activated. If there are several limitations, their priorities need to be considered.

After the limitations are cancelled or the Auto. Operation is re-activated, the fan switching and the control value are recalculated and executed. This means that the fan switching will be executed according to the latest control value.

After programming or bus voltage recovery, if the control value has been not received before the Auto. Operation active and the limitations are not activated, now the output is no action.

Parameter “Fan with limitation x (x=1, 2, 3, 4)”

With this parameter, the fan switching can be set in active limitation. There are the same parameters for each of the individual four limitations. Options:

Deactive

Unchanged

ON

OFF

Deactive: The limitation is not effect to the Auto. Operation, but the status can be activated.

Unchanged: The fan status is remained the current status when the limitation is activated.

ON: The fan is only switched on when the limitation is activated.

OFF: The fan is only switched off when the limitation is activated.

5.5.2.2 Parameter window “Fan: Status”

The parameter window “Fan: Status” is shown in fig.5.29. Here the status messages are defined for the Fan-one level.

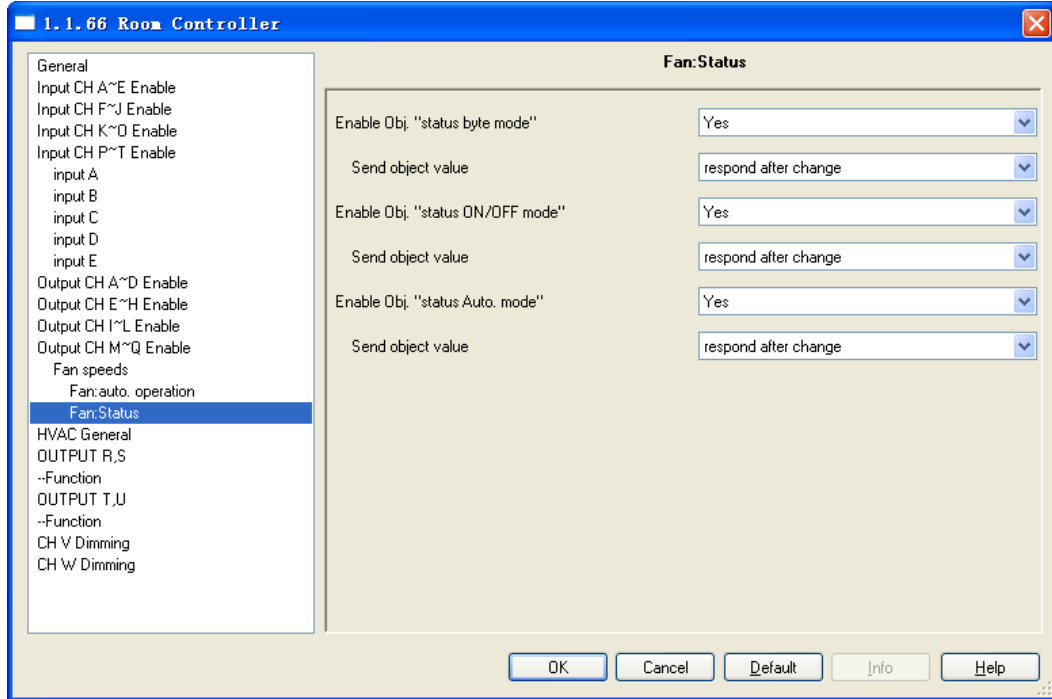

Fig. 5.29 parameter window “Fan-one level:Status”

Parameter “Enable Obj. “status byte mode” ”

Options:

- Yes
- No

With the “Yes”, the communication object “Fan status byte mode” is enabled. The different states are indicated directly via a bit coding, as follows:

object “Fan status byte mode”								
Data bits	Bit7	Bit6	Bit5	Bit4	Bit3	Bit2	Bit1	Bit0
Function	Forced operation	Limit1	Limit 2	Limit 3	Limit 4	Thermostat fault	Auto. operation	Heating/ Cooling
values	0:inactive 1:active	0:inactive 1:active	0:inactive 1:active	0:inactive 1:active	0:inactive 1:active	0:inactive 1:active	0:inactive 1:active	0:Cooling 1:Heating

Note: Currently bit0 and bit2 are unused.

With option yes the following parameter appears:

—Parameter “Send object value”

Options:

Respond, after read only

Respond after change

With the “Respond, after read only”, the status is sent after a request.

With the “Respond after change”, the status is send after a change or a request.

Parameter “Enable Obj. “status ON/OFF mode” ”

Options :

Yes

No

With the “Yes”, the communication object “Fan status ON/OFF” is enabled. The fan status ON/OFF is indicated directly via the object. Telegram value: 1— the Fan ON, 0 — the Fan OFF.

With option yes the following parameter appears:

—Parameter “Send object value”

Options :

Respond, after read only

Respond after change

With the “Respond, after read only”, the status is sent after a request.

With the “Respond after change”, the status is send after a change or a request.

Parameter “Enable Obj. “status Auto. mode” ”

The parameter only appears if the automatic operation is enabled in the fan-one level parameter window.

Options:

Yes

No

With the “Yes”, the communication object “Fan status automatic” is enabled. The Automatic operation status is indicated directly via the object. Telegram value 1—Auto. Operation active, 0 — Auto. Operation inactive.

With option yes the following parameter appears:

—Parameter “Send object value”

Options:

Respond, after read only

Respond after change

With the “Respond, after read only”, the status is sent after a request.

With the “Respond after change”, the status is send after a change or a request.

5.5.3 Parameter “Fan-multi level”

The parameter window of multi level fan speeds is shown in fig.5.30. Here can set 2 level or 3 level fan speeds. 2 levels are the output O and P, 3 levels are the output O, P and Q. The parameter settings as follow:

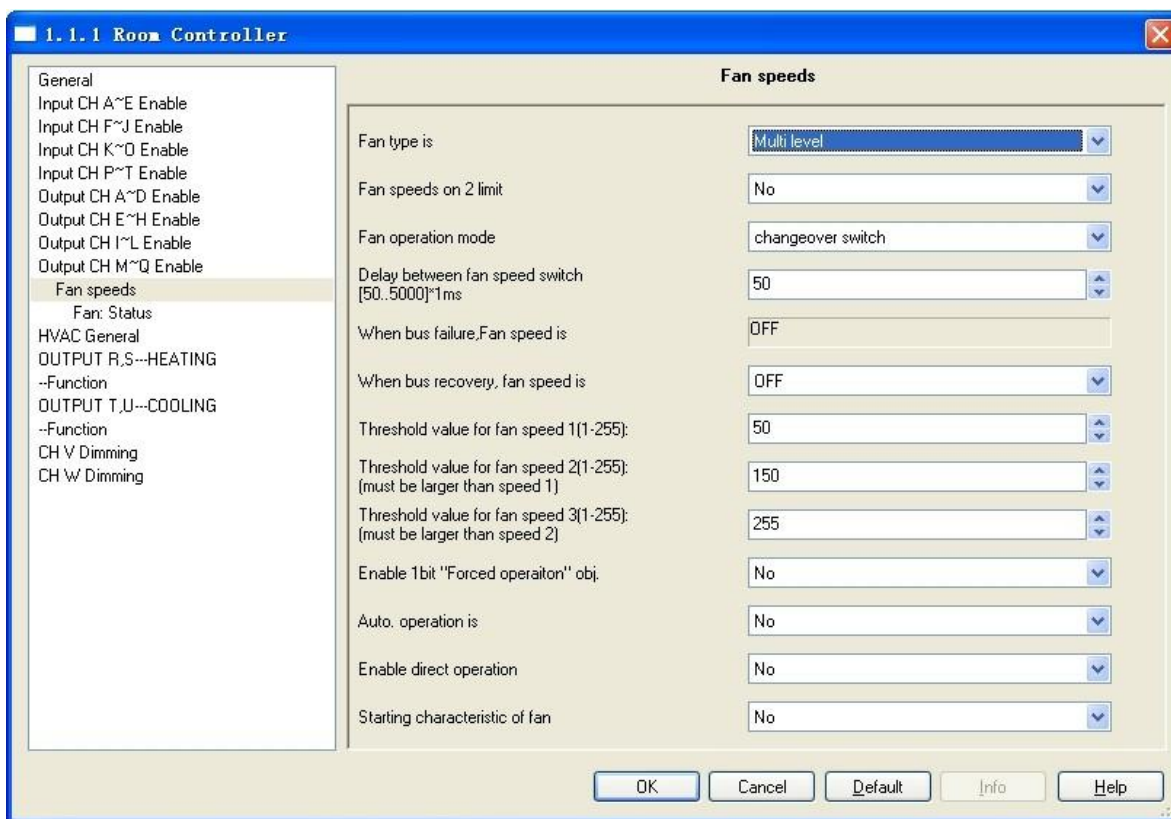

Fig. 5.30 parameter window “Fan-two level”

The two level fan speeds and the three level fan speeds have the same parameter settings. Just the fan speeds are limited to two, the fan speed 3 is non-functional.

Some technical characteristics need to be considered with a multi level speed fan, such as fan operation mode, starting characteristic etc. Only know these characteristics, you can set the following parameters reasonably.

Parameter “Fan speeds on 2 limit”

With the parameter, the fan speeds can be limited to two. Options:

No

Yes

With the “No”, a three speed fan is controlled.

With the “Yes”, a two speed fan is controlled via fan speeds 1 and 2, fan speed 3 is non-functional. The following settings are the same as those for a three speed fan, but are only limited to two speeds.

Parameter “Fan operation mode”

The control of the fan is set with this parameter. The mode of fan control should be taken from the technical data of the fan. Options:

Changeover switch

Step switch

Changeover switch: Only the corresponding output of the assigned fan speed is switched on with the parameterisation. The delay time between the speed switchover and a minimum dwell time in a valve speed are programmable. The minimum dwell time in a fan speed is only active in automatic mode. With the changeover switch, the fan speed is directly switched on, as follows:

Output Fan speed	Output O	Output P	Output Q
Off	0	0	0
Fan speed 1	1	0	0
Fan speed 2	0	1	0
Fan speed 3	0	0	1

Step switch: The individual fan speeds are activated consecutively (outputs switched on) until the required fan speed is achieved. The minimum dwell time in a fan speed is also only active in automatic mode. A step switch normally means that the previous fan speeds are usually switched on consecutively, as follows.

Output Fan speed	Output O	Output P	Output Q
Off	0	0	0
Fan speed 1	1	0	0
Fan speed 2	1	1	0
Fan speed 3	1	1	1

——Parameter “Delay between fan speed switch [50…5000]*1ms”

The parameter is visible if the fan operation mode selects “changeover switch”, which is used to set a switchover delay. This time is a fan specific factor and it is always taken into consideration. Options: 50...5000

After a target fan speed telegram is received, the target fan speed is carried out as soon as the delay has passed. However, switch the fan on do not need delay, switch the fan off need delay.

If a new fan speed is received during the delay, the delay is not restarted and the new fan speed is carried out in the last.

Parameter “When bus failure, Fan speed is”

The parameter defines that the behavior of the fan on bus voltage failure is off.

Parameter “When bus recovery, fan speed is”

The behavior of the fan on bus voltage recovery is defined here. Options:

- OFF
- 1
- 2
- 3

With the “OFF”, the fan is switched off.

With the “1, 2 or 3”, the fan switches to fan speed 1, 2 or 3.

Note: it is advisable to apply a bus voltage before connecting the fan in order to achieve a defined switch state of the fan. This eliminates the possibility of the destruction of the fan due to an incorrect contact setting. If the fan speed is limited to 2 levels, but the parameter is with 3, then the fan speed will use 2 after bus voltage recovery.

Parameter “Threshold value for fan speed 1(1-255):”

The parameter is used to set a threshold value for switching to fan speed 1.if value of fan speed is no less than the value,then fan will run at speed 1,otherwise fan will be cut off.Option:1-255

Parameter “Threshold value for fan speed 2(1-255):”

The parameter is used to set a threshold value for switching to fan speed 2.if value of fan speed is no less than the value,then fan will run at speed 2.Option:1-255

Parameter “Threshold value for fan speed 3(1-255):”

The parameter is used to set a threshold value for switching to fan speed 3.if value of fan speed is no less than the value,then fan will run at speed 3.Option:1-255

Parameter “Enable 1bit ‘Force operation’ obj.”

Options:

No

Yes

With the “Yes”, a 1bit communication object “Fan Forced Operation” is enabled. The follow two parameters appear at the same time:

——**Parameter “Forced operation on object value is”**

Options:

0

1

1: the Forced operation is activated by a telegram value 1 of the object “Fan Forced Operation” and is cancelled by value 0.

0: the Forced operation is activated by a telegram value 0 of the object “Fan Forced Operation” and is cancelled by value 1.

Note: During Forced operation, the limits setting in Automatic operation are ignored. Automatic operation is updated after Forced operation has been rescinded. The Forced operation is not activated by default after bus voltage recovery or programmed.

——**Parameter “Limitation on Force operation”**

This parameter sets which fan speeds are set with active Forced operation or which may not be exceeded or undershot. Options:

Unchanged

3, 2, 1, off

1

1, off

2

2, 1

2, 1, off

3

3, 2

3, 2, 1

Off

Unchanged: the state is retained.

3, 2, 1, off: Everything is possible.

1: Limited to speed 1, the control value is ignored.

1, off: Limited to speed 1 and off.

2: Limited to speed 2, the control value is ignored.

2, 1: Limited to speed 1 and 2.

2, 1, off: Limited to speed 1, 2 and off.

3: Limited to speed 3, the control value is ignored.

3, 2: Limited to speed 3 and 2.

3, 2, 1: Limited to speed 1, 2 and 3.

Off: The fan is only switched off.

Note: In case of activation forced operation, if the current fan speed not in the allowed range, the speed will be close to the current fan speed to switch to the fan within the allowable range, for example, the current fan speed is 1, the permissible speed is 2 and 3, then when activated forced operation, the speed will automatically switch to 2, if the fan speed to be manually switched to 1, the running speed will be also 2.

Alternatively, if the current speed is 0, the permissible speed is 1, 2 and 3, the starting up fan speed is 3, then when activating forced operation, the fan is started up with speed 3, and then automatically switches to speed 1. Another case if the current fan speed is 2, the permissible fan speed is 1 and 2, then when activated forced operation, the device receive a telegram with fan speed 0, then the fan speed will be switched to 1, this case is that the fan speed is switched to the speed near the target speed.

Parameter “Auto. Operation is”

Options:

No

Yes

With the “Yes”, Automatic mode is enabled, an additional – Automatic operation parameter window (fig.5.31) appears.

Parameter “Enable direct operation”

The direct operation is enabled with the parameter. The fan speeds can be switched manually in a different way via the direct operation. Select the control way according to the actual use. Options:

No

Yes

Yes: the following three parameters are visible. Each parameter corresponds to a control way.

Note: the parameterized minimum dwell time in the fan speed for automatic mode is ignored during manual operation. Accordingly, an immediate reaction to the manual operation is detected. The delay time with speed switch over remains active to protect the fan. And if the forced operation is activated, it will remain valid and is considered.

—Parameter “Enable ‘Switch speed x’ obj.”

Options:

No
Yes

Yes: Three 1bit communication objects “Fan speed 1”, “Fan speed 2” and “Fan speed 3” are enabled. When the object “Fan speed x” receives a telegram “1”, the fan speed x is switched on. An off telegram to one of three communication objects, the fan is switched off completely. If several ON/OFF telegram are received consecutively in a short period of time at various Fan speed 1-3 communication objects, the value last received by the fan control is the decisive value.

—Parameter “Enable ‘Fan speed Up/Down’ obj.”

Options:

No
Yes

Yes: A 1bit communication object “Fan speed UP/DOWN” is enabled. When the object receives a telegram “1”, a fan speed is switched UP, and a fan speed is switched DOWN with telegram “0”.

If the maximum fan speed is achieved and a further telegram with the value 1 is received, the fan speed will remain as it is.

With multiple manual UP or DOWN switching, the target speed will be increased or reduced by a speed step. This is possible until the maximum or minimum possible speed is achieved. Further UP or DOWN telegrams are ignored and not executed.

If several UP/DOWN telegram are received consecutively in a short period of time, the target speed will be consecutively increased or reduced multi-step, such as the current fan speed is 1, after receive two UP telegrams, the fan speed will be increased to 3.

—Parameter “Enable ‘Fan speed switch’ obj.”

Options:

No

Yes

Yes: A 1byte communication object“Fan speed switch”is enabled. The object values result: 0—OFF, 1—fan speed 1, 2 — fan speed 2, 3—fan speed 3, values greater than 3 are ignored.

Parameter “Starting characteristic of fan”

This parameter enables the fan to start from the off state with a defined fan speed. In our daily life, such as stand fan, when you turn on the fan, the fan speed is usually started up from the second stage, then switch to the minimum fan speed. The start-up behavior of the fan is similar to this. It can be useful to start the fan motor first with a higher fan speed to guarantee a safe start of the fan motor. Thus, a higher torque for the start up phase of the fan is achieved. Options:

Yes

No

Yes: the follow two parameters appear.

Note: The start-up behavior is a technical characteristic of the fan. For this reason, this behavior has a higher priority than an active limitation or forced operation. For example, if a limitation is activated in fan speed 2 and a start-up behavior is parameterized via fan speed 3, the following behavior will result: The fan is in the OFF state and receives a control signal for fan speed 1. Initially the fan operates at fan speed 3(start-up speed) and then proceeds to fan speed 2, which is defined by the limitation. The actual required fan speed 1 will not be achieved due to the limitation.(the limitation is described in automatic operation section 5.5.3.1)

The dwell times in a fan speed, which are considered in automatic mode, are inactive and will only be considered after the start up phase. The minimum dwell period for the start up phase can be defined separately via the following parameter “Minimum dwell period in switch”.

——Parameter “Switch on over fan speed”

Here you set the fan speed used to start from the OFF state. Options:1/2/3

——Parameter “Minimum dwell period in switch”

This parameter defines the minimum dwell time for one of the switch on speeds. Options:1 ...65535

When the fan is turned on, first it will start up with a specified fan speed, and the min. dwell time has passed, and switch to the target speed. Meantime, the delay time with speed switch over remains active to protect the fan.

Example: Starting characteristic of a three speed fan

Suppose that the current speed is OFF, the start-up speed is 3, the target speed is 2 and the end speed is 2. As

shown below:

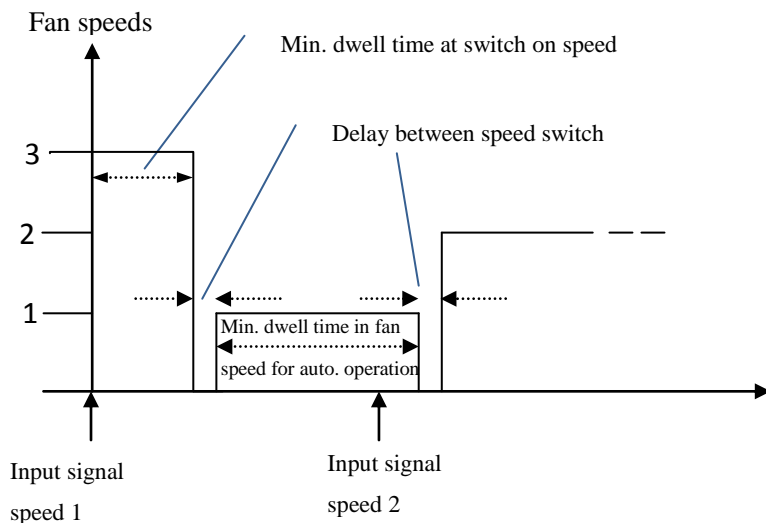

The above illustration shows the actual speed is 0, when the device receives a control signal for speed 1, the fan will be started up with speed 3, and then the min. dwell time at switch on speed has passed and the delay between speed switch has passed, then switch to the target speed 1. After some time the device receives a control signal for speed 2, then at this time it is taken into account whether the automatic operation is activated, if activated, there is min. dwell time in fan speed for auto. Operation, if inactivated, the delay between speed switch has passed, then switch to the target speed 2.

5.5.3.1 Parameter window“Fan: Auto. Operation”

This parameter window (fig.5.31) is visible if in fig. 5.30 the option yes has been selected in the parameter “Auto. Operation is”. Here set the auto. Operation of multi level fan and three threshold values for switchover of the fan speed in auto. Operation are defined. If the control value is lower than the threshold value 1, the fan is off; if the control value is greater than or equal to the threshold value 1, the fan is switched to speed 1; if the control value is greater than or equal to the threshold value 2, the fan is switched to speed 2; if the control value is greater than or equal to the threshold value 3, the fan is switched to speed 3. You can also set a hysteresis value. The control value is received via the object “HVAC-General HEAT/COOL”, “HVAC-General HEAT”or “HVAC-General COOL”. Furthermore, the 4 limitations can also be enabled.

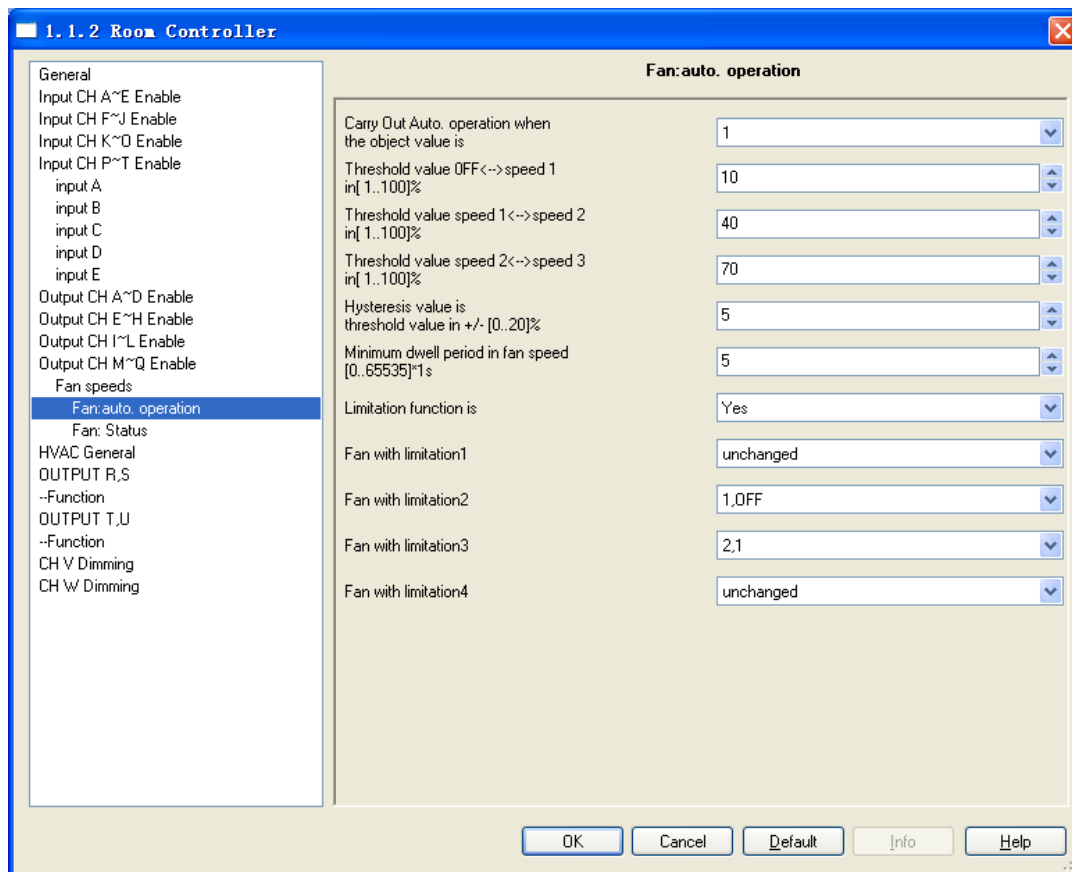

Fig. 5.31 parameter window“Fan-multi level:Auto. operation”

Parameter “Carry out Auto. Operation when the object value is”

This parameter defines how to react to a telegram value of the communication object “Fan Automatic ON/OFF”. Options:

- 0
- 1

1: Automatic is activated by a telegram with value 1 and inactive by value 0.

0: Automatic is activated by a telegram with value 0 and inactive by value 1.

The automatic operation is inactive by default after bus voltage recovery.

Parameter “Threshold value OFF<->1 in [1…100] %”

Here the threshold value, at which switch on of fan speed 1 occurs, is defined. Options: 1...100%

If the value in the control value communication object is greater than or equal to the parameterized threshold value, fan speed 1 is switched on. If the value is less, it is switched off.

Parameter “Threshold value 1<->2 in [1…100] %”

Here the threshold value, at which switch on of fan speed 2 occurs, is defined. Options: 1...100%

If the value in the control value communication object is greater than or equal to the parameterized threshold value, switch over to fan speed 2 occurs.

Parameter “Threshold value 2<->3 in [1...100] %”

Here the threshold value, at which switch on of fan speed 3 occurs, is defined. Options: 1...100%

If the value in the control value communication object is greater than or equal to the parameterized threshold value, switch over to fan speed 3 occurs.

Note: the room controller evaluates the threshold values in ascending order, i.e. first of all the threshold value for OFF <-> fan speed 1 is checked followed by fan speed 1 <-> fan speed 2 etc.

The correct method of function is only assured if the threshold value for OFF <-> fan speed 1 is less than the threshold value fan speed 1 <-> fan speed 2, and this is less than fan speed 2 <-> fan speed 3, etc.

Parameter “Hysteresis value is threshold value in +/- [0...20] %”

Here a hysteresis value is set, at which switchover to the next fan speed occurs. Using hysteresis, a continuous switching between the fan speeds around the threshold value with the control value deviating can be avoided. Options: 0...20%

The hysteresis applies for all three threshold values.

The setting 0 causes immediate switching without hysteresis.

Assuming the hysteresis value of 5% and the threshold value is 50%, then the upper threshold value will be 55% (the threshold value + the hysteresis value), the lower threshold value will be 45% (the threshold value - the hysteresis value), then when the control value is between 45% and 55%, it will not cause the operation of the fan, only when less than 45% or greater than 55%, switch over fan speed occurs. As shown below:

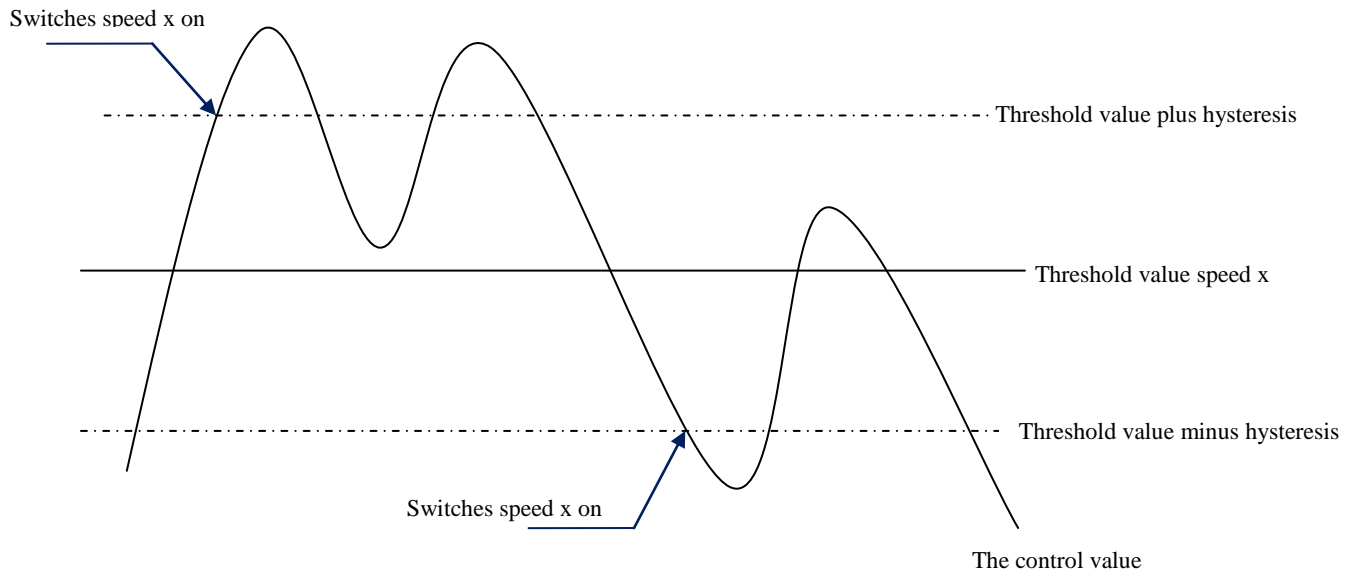

Note:

How does the fan react if the switch thresholds overlap by the use of hysteresis?

- 1) *The hysteresis defines from which point the set speed transition occurs.*
- 2) *If the speed transition occurs, the new speed is determined using the control value and the set switch thresholds. The hysteresis is not considered.*

Example (1):

Parameterized:

Threshold value OFF <-> speed 1 = 10%

Threshold value speed 1 <-> speed 2 = 20%

Threshold value speed 2 <-> speed 3 = 30%

Hysteresis 15%

Behavior when ascending from speed 0:

Speed 0 transition at 25% ($\geq 10\% + 15\%$). The new speed is 2 (25% is between 20% and 30%, the hysteresis is not considered), accordingly speed 1 is omitted.

Behavior when descending from speed3:

Speed 3 transition at 14% ($< 30\% - 15\%$), the new speed is 1 (14% is between 10% and 20%, the hysteresis is not considered), accordingly speed 2 is omitted.

Example (2):

Parameterized:

Threshold value OFF <->speed 1 = 10%

Threshold value speed 1 <->speed 2 = 40%

Threshold value speed 2 <->speed 3 = 70%

Hysteresis 5%

Behavior when ascending from speed 0:

Speed 0 transition at 15% ($\geq 10\% + 5\%$). If the device receives an ontrrol value of 41%, the new speed will be 2 (41% is between 40% and 70%, the hysteresis is not considered), accordingly speed 1 is omitted. However, if the device receives an ontrrol value of 39%, the new speed will be 1 (39% is between 10% and 40%, the hysteresis is not considered).

Behavior when descending from speed3:

Speed 3 transition at 64% ($< 70\% - 5\%$). If the device receives an ontrrol value of 39%, the new speed is 1 (39% is between 10% and 40%, the hysteresis is not considered), accordingly speed 2 is omitted.

3) A control variable with the value 0 always results in speed 0.

Parameter “Minimum dwell period in fan speed [0...65535]*1s”

This parameter defines the dwell time for a fan speed of the fan until it switches to the next higher or lower fan speed. If you need switch the fan speed to other speed, only when the min. dwell time has passed, switch to the next speed. If the current fan speed has been running long enough, then the speed can be switched to the next speed quickly. Options: 0...65535

0: means a non-delayed switching.

Note: the dwell time in a fan speed is only considered in automatic mode. Each fan speed (including off) for automatic mode need to consider this dwell time, and the fan speed in automatic operation is switched step by setp, such as the current fan speed is 1, the target speed is 3, then the fan will switch the speed to two, then to three. Start-up fan speed is unnecessary to consider this dwell time, because its dwell time can be set separately in parameter window 5.30.

Parameter “Limitation function is”

The parameter set the limitation function of the Auto. Operation. Options:

Yes

No

With the “yes”, the following parameters appear, and 4 communication objects for limitation of the fan speed are enabled.

Four limitations are available. They can be used for example for the control of various operation modes such as:

Limitation 1: e.g. for frost/heat protection

Limitation 2: e.g. for comfort operation

Limitation 3: e.g. for night shutdown

Limitation 4: e.g. for standby operation

In normal cases, the thermostat takes these operating modes into account in its control variable for the room controller.

The sequence of the displayed parameters corresponds with their priorities, i.e. limitation 1 has the highest priority followed by limitation 2, 3 and 4. So the highest priority is assigned to limitation 1, e.g. Frost/Heat protection; the lowest priority is assigned to limitation 4, e.g. standby operation.

The limitation is activated if a telegram 1 is received on the limitation object. The limitation is deactivated if a telegram 0 is received on the limitation object.

The direct operation can end the Auto. Operation, but the limitations status can be maintained, it will affect the Auto. Operation again when the Auto. Operation is activated again. And even if the limitations can be also activated during the forced operation, but they only affect the Auto. Operation.

If a limitation is activated during the Auto. Operation, the room controller switches to the parameterized fan speed regardless of the control value. If during the activation of the limitation another fan speed or a fan speed outside the range of the “limitation range” is set, the required fan speed or the limit fan speed of the range is set. If there are several limitations, their priorities need to be considered.

After the limitations are cancelled, the fan speed and the control value are recalculated and executed. This means that during limitation the room controller operates normally in the background, the output are not change, and implementation only occurs after the end of limitation.

If the control value has been not received before the Auto. Operation active after programming or bus voltage recovery, then in case of no limitation the output is no action when the auto. Operation is activated. If there are limitations, the speed will be close to the current fan speed to switch to the fan within the limitation range,

Parameter “Fan with limitation x (x=1, 2, 3, 4)”

With this parameter, Speed ranges (limitations) are defined for the fan with the speed limitation function. You set which fan speed is set with active limitation or which speed is not exceeded or undershot. Options:

Unchanged

3, 2, 1, off

1

1, off

2

2, 1

2, 1, off

3

3, 2

3, 2, 1

Off

Unchanged: the state is retained.

3, 2, 1, off: Everything is possible.

1: Limited to speed 1, the control value is ignored.

1, off: Limited to speed 1 and off.

2: Limited to speed 2, the control value is ignored.

2, 1: Limited to speed 1 and 2.

2, 1, off: Limited to speed 1, 2 and off.

3: Limited to speed 3, the control value is ignored.

3, 2: Limited to speed 3 and 2.

3, 2, 1: Limited to speed 1, 2 and 3.

Off: The fan is only switched off.

5.5.3.2 Parameter window“Fan: Status”

The parameter window “Fan: Status” is shown in fig.5.32. Here the status messages are defined for Fan-multi level.

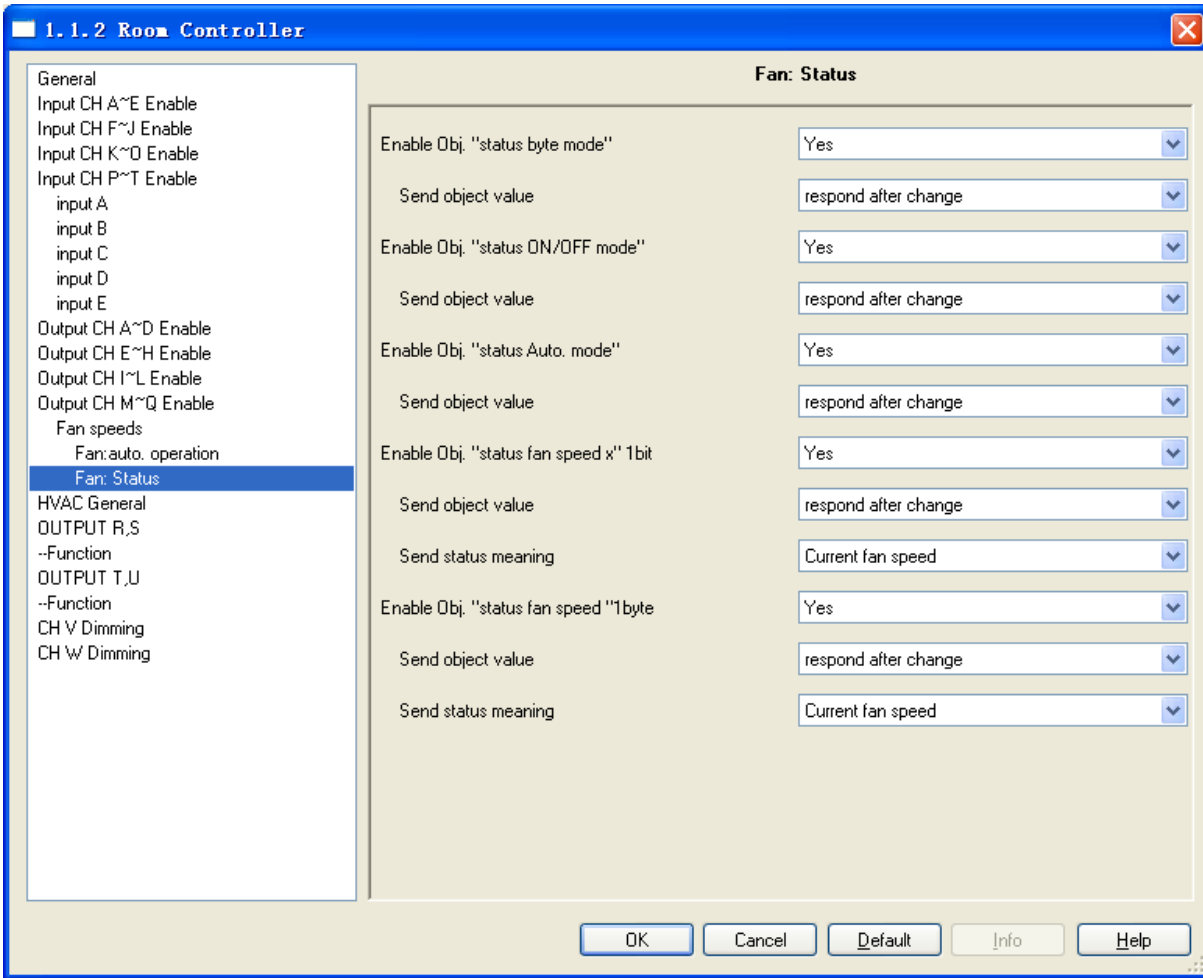

Fig. 5.32 parameter window “Fan-multi level:Status”

Parameter “Enable Obj. “status byte mode” ”

Options:

- Yes
- No

With the “Yes”, the communication object “Fan status byte mode” is enabled. The different states are indicated directly via a bit coding, as follows:

object “Fan status byte mode”								
Data bits	Bit7	Bit6	Bit5	Bit4	Bit3	Bit2	Bit1	Bit0
Function	Forced operation	Limit1	Limit 2	Limit 3	Limit 4	Thermostat fault	Auto. operation	Heating/ Cooling
values	0:inactive 1:active	0:inactive 1:active	0:inactive 1:active	0:inactive 1:active	0:inactive 1:active	0:inactive 1:active	0:inactive 1:active	0:Cooling 1:Heating

Note: Currently bit0 and bit2 are unused.

With option yes the following parameter appears:

—Parameter “Send object value”

Options:

Respond, after read only

Respond after change

With the “Respond, after read only”, the status is sent after a request.

With the “Respond after change”, the status is send after a change or a request.

Parameter “Enable Obj. “status ON/OFF mode” ”

Options :

Yes

No

With the “Yes”, the communication object “Fan status ON/OFF” is enabled. The fan status ON/OFF is indicated directly via the object. Telegram value 1— the Fan ON, 0 — the Fan OFF.

With option yes the following parameter appears:

—Parameter “Send object value”

Options :

Respond, after read only

Respond after change

With the “Respond, after read only”, the status is sent after a request.

With the “Respond after change”, the status is send after a change or a request.

Parameter “Enable Obj. “status Auto. mode” ”

The parameter only appears if the automatic operation is enabled in the fan-multi level parameter window.

Options:

Yes

No

With the “Yes”, the communication object “Fan status automatic” is enabled. The Automatic operation status is indicated directly via the object. Telegram value 1—Auto. Operation active, 0 — Auto. Operation inactive.

With option yes the following parameter appears:

—Parameter “Send object value”

Options:

Respond, after read only

Respond after change

With the “*Respond, after read only*”, the status is sent after a request.

With the “*Respond after change*”, the status is send after a change or a request.

Parameter “Enable Obj. “status fan speed x” 1bit”

Options:

Yes

No

With the “*Yes*”, three 1bit communication objects, Status fan speed x, x=1 to 3 are enabled. The status of the current fan speed is displayed via these communication objects.

With option yse the following parameter appears:

——Parameter “Send object value”

Options:

Respond, after read only

Respond after change

With the “*Respond, after read only*”, the status is sent after a request.

With the “*Respond after change*”, the status is send after a change or a request.

Parameter “Enable Obj. “status fan speed” 1byte”

Options:

Yes

No

With the “*Yes*”, a 1byte communication object “Fan status speed” is enabled. The status of the current fan speed is displayed via the communication object. Telegram value 0—Fan OFF, 1—Fan speed 1, 2—Fan speed 2, 3—Fan speed 3, >3— not used.

With option yse the following parameter appears:

——Parameter “Send object value”

Options:

Respond, after read only

Respond after change

With the “*Respond, after read only*”, the status is sent after a request.

With the “*Respond after change*”, the status is send after a change or a request.

5.5.4 Parameter window“Switch-output O, P, Q”

When the O,P,Q as three channels switching output, parameter setting interface as shown in fig. 5.33. Here parameters and functions are similar to the switch actuator of the chapter 5.3. The differents that there is not logic function and the time funcations have own communication object rather than multiplex object with common switch operation, so the control process in fig.5.10 is not apply to here.

Here each funcuation has its own object. Please see the chapter 6.4.2 description.

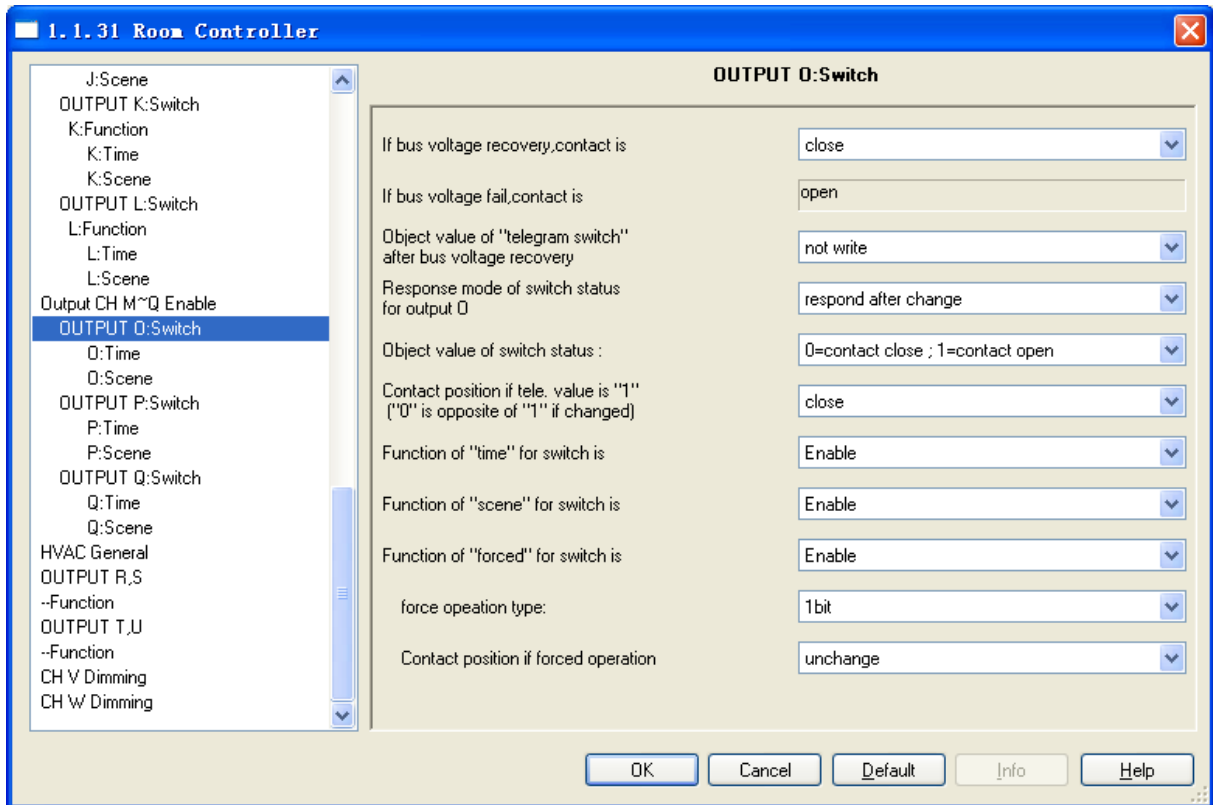

Fig. 5.33 parameter window “Switch- outputs O,P,Q”

5.6 HVAC system (R~U)

This chapter introduces HVAC system of the valve control unit, following the fan control of the previous section. The room controller can be used to control 2-pipe, 3-pipe or 4-pipe system. The fan and the HVAC system can be parametersed independently. Therefore, when we use the room controller to control the valve, we need to consider both the fan and HVAC system parameter settings and reasonably set them in order to the two parts to better work together.

The valve is the end product of central air-conditioning, thus the function of the room controller is mainly used in places with central air-conditioning, to give a room heating, cooling and ventilation.

Pipe systems description:

In daily life, a fan coil unit can be configured as a 4-, 3- or 2-pipe system.

The 2 pipe system consists of just a single water circuit, which is heated or cooled alternately to suit the season. In a 2 pipe fan coil unit, there is only one heat exchanger with a valve for heating or cooling, the control value for heating or cooling is provided by a thermostat, only warm or only cold water is supplied centrally to the pipe system. Connections of 2 pipe system: the fan and the valve HEATING (output R, S), the valve COOLING (output T, U) is not usable or independently usable. In many HVAC systems, cooling is undertaken exclusively with a 2 pipe fan coil unit. The heating function is undertaken by a conventional heater or an electrical heater in the fan coil unit.

The 3 pipe system has a similar design to the 4 pipe system. It has a separate inlet for heating and cooling water as well as two separate heat exchangers with one valve each. In contrast to a 4 pipe system the 3 pipe system has a common return flow for heating or cooling water. In a 4 pipe system, separate water circulation loops are used for heating and cooling water. Thus there are also two separate heat exchangers for heating and cooling which are each triggered via a valve. Warm and cold water is provided centrally to two separate pipe system. The thermostat onsite decides if heating or cooling is applied. Connections of 3-, 4-pipe system: the fan, the valve HEATING (output R, S) and the valve COOLING (output T, U).

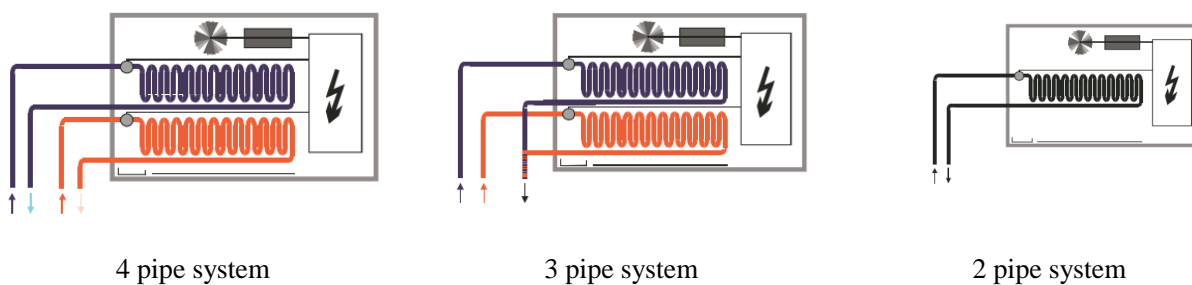

All settings for the control input are undertaken in the follow parameter window.

5.6.1 Parameter window“HVAC General”

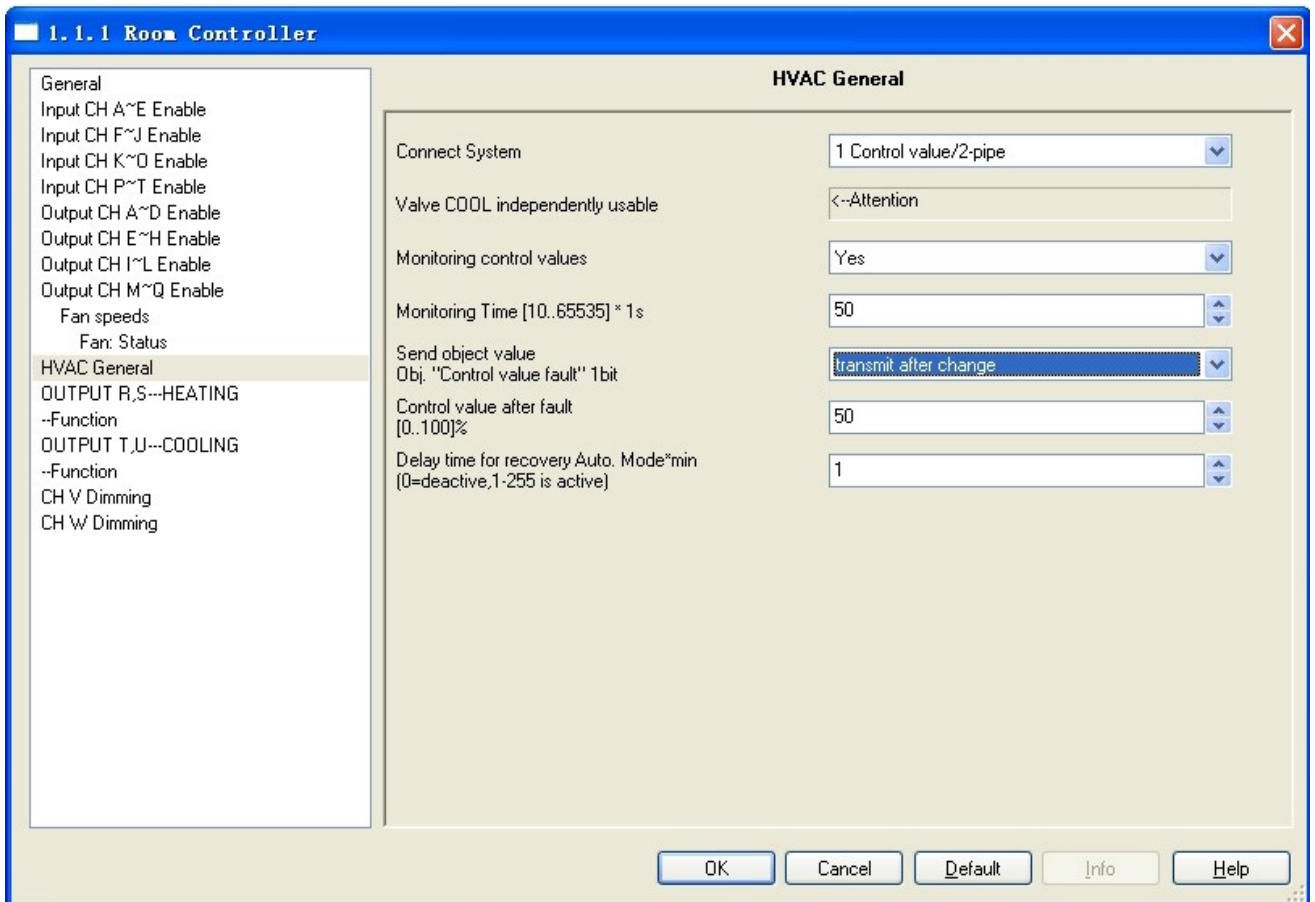

Fig. 5.34 parameter window “HVAC General”

Parameter “Connect System”

This parameter defines the pipe system that is used with the room controller. Options:

- 1 Control value/2-pipe*
- 1 Control value/4-pipe with switch obj.*
- 2 Control value/2-pipe*
- 2 Control value/2-pipe with switch obj.*
- 2 Control value/4-pipe*

The individual functions are described in the following chapters.

If a valve is deactivated due to a conversion of the HVAC system, the valve will be fully closed.

Parameter “Monitoring control values”

Options:

- Yes*
- No*

Yes: the fault monitoring is enabled, and the communication object “Fault control value” appears. Hereby a thermostat can be cyclically monitored, if the control signal from the thermostat is not received in monitoring time, the room controller will send a fault report via the object “Fault control value”, and perform a valve adjustment according to parameter setting.

With option yes, the following parameters appear:

——Parameter “Monitoring Time [10…65535]*1s”

With this parameter, the monitoring time can be set, which used to monitor all telegrams on the input/setting values of the room controller is set : communication objects “HVAC-General HEAT/COOL”, “HVAC-General COOL” or “HVAC-General HEAT”. If a setting variable is not received within the parameterized time, a communication malfunction has occurred and a fault valve adjustment is activated. Option: 10…65535 s

Note: It must be assured that the monitoring time is set to at least factor 3 larger than the set sending time of the thermostat so that the valve is not immediately adjusted to the position of occurred fault due to the negligible omission of a signal, e.g. due to a high bus load.

——Parameter “Send object value Obj. ‘Control value fault’ 1bit”

The parameter defines how to respond a fault report. Options:

No reply

Transmit after change

Always respond, after read only

With the “no reply”, the status is not sent, and the object “control value fault” value is always 0.

With the “transmit after change”, the status is send after a change or a request.

With the “always respond, after read only”, the status is only sent after a request.

——Parameter “Control value after fault [0…100%]”

With the parameter, the reaction of the room controller to a setting value not received can be defined. Option: 0…100%

Parameter “Delay time for recovery from Auto. Mode*min”

The Parameter defines delay time from manual mode to automatic mode for valve control, that is said valve control function will run at automatic mode after the delay time from the last manually control. Option: 0…255

Note: If the value is set as “0”, this function will be deactive. In this case, if manual function is not cancelled after manually control (long operation the button K(HEAT) or L(COOL) can cancel manual function), the valve

can't be controlled by other devices

If a control signal from the thermostat is not received in monitoring time, the room controller will perform a valve adjustment according to the control value of the parameter setting.

5.6.1.1 1 Control value/2-pipe

The 2-pipe system is only with a control object that is used to control the heating valve. The cooling valve can be used additionally and independently via an extra communication object. The advantage of this way can achieve some rooms heating, while other some rooms cooling.

Parameter “Valve COOL independently usable”

The parameter serves as a remark that the cooling valve can be used independently.

Valve COOLING

The cooling valve can be controlled additionally and independently via the communication object “HVAC-General COOL”, and it is not monitored in the process.

In the case of the valve control mode “Continuous, PWM”, output U is effective.

In the case of the valve control mode “3 point, open and close”, output T is used to close the valve (100% → 0%), output U is used to open the valve (0% → 100%).

Valve HEATING

Via the communication object “HVAC-General HEAT/COOL” the heating valve and the fan can be controlled.

In the case of the valve control mode “Continuous, PWM”, output S is effective.

In the case of the valve control mode “3 point, open and close”, output R is used to close the valve (100% → 0%), output S is used to open the valve (0% → 100%).

5.6.1.2 1 Control value/4-pipe with switch obj.

The 4-pipe system is only with a control object that is used to control the heating valve and the cooling valve. And toggle between the heating valve and the cooling valve is implemented via a separate communication object.

Parameter “Toggle by separately object”

The parameter serves as a remark that between the heating valve and the cooling valve can be toggled via a separate object.

Valve HEATING/ Valve COOLING

Via the communication object“HVAC-General HEAT/COOL” the heating/cooling valve and the fan can be controlled.

And toggle between the heating valve and the cooling valve is implemented via the separate communication object“HVAC-General Toggle HEAT/COOL”. The corresponding inactive valve is thus automatically closed when toggled. The control value is updated after the valve enabled, for example, the object“HVAC-General HEAT/COOL” receives a control value of 40% during heating, and the cooling still maintains its last control value until it is enabled. I.e. the cooling control value is updated to 40% after it is enabled.

When the object “HVAC-General HEAT/COOL” receives a control value or the object “HVAC-General Toggle HEAT/COOL”receives a toggle value, the monitoring time is re-started. After bus voltage recovery if the heating and the cooling is toggled, the fault is also reset instead of maintain.

During the heating, the communication object that is used for disable the cooling is unusable, so the value that it receives is invalid, and vice versa.

In the case of the valve control mode“Continuous, PWM”, output S is effective in the heating operation; output U is effective in the cooling operation.

In the case of the valve control mode “3 point, open and close”, if the heating operation, output R is used to close the valve (100%→0%), output S is used to open the valve (0%→100%). If the cooling operation, output T is used to close the valve (100%→0%), output U is used to open the valve (0%→100%).

Parameter “Operation HEAT/COOL after bus recovery”

With the parameter, the reaction after bus voltage recovery is set. Options:

- Unchanged*
- HEAT*
- COOL*

Unchanged: After bus voltage recovery, the state that existed before bus voltage failure is re-established.

HEAT: After bus voltage recovery, the heating state is set.

COOL: After bus voltage recovery, the cooling state is set.

Note: *After download parameters, the heating state is set by default.*

Parameter “Object value for ‘Toggle HEAT/COOL obj.’ ”

With the parameter you set the object value used to toggle between heating and cooling. Options:

- 0

1

0: As soon as a telegram value 0 is received, heating is activated and cooling is deactivated.

1: As soon as a telegram value 1 is received, heating is activated and cooling is deactivated.

5.6.1.3 2 Control value/2-pipe

The 2-pipe system has two control objects act on the heating valve; the cooling valve is not used.

Parameter “Toggle automatically, Valve COOL not usable”

The parameter serves as a remark that between the heating and the cooling can be toggled via automatically, and the valve COOLING is not usable. The communication objects in conjunction with the cooling valve, e.g. status, forced operation or valve purge are not effective.

Valve HEATING/ COOLING

Via the communication object “HVAC-General HEAT” or “HVAC-General COOL” the heating valve and the fan can be controlled.

Toggling between heating and cooling is implemented by updating the control values. The control values is updated via the object “HVAC-General HEAT” or “HVAC-General COOL”. I.e. the switch over between heating/cooling should occur exclusively with the respective thermostat. Here only heating or cooling are active, dependent on the last active received control value.

When the object “HVAC-General HEAT” or “HVAC-General COOL” receives a control value, the monitoring time is re-started. After bus voltage recovery if the heating and the cooling is toggled, the fault is also reset instead of maintain.

In the case of the valve control mode “Continuous, PWM”, output S is effective.

In the case of the valve control mode “3 point, open and close”, output R is used to close the valve (100% → 0%), output S is used to open the valve (0% → 100%).

Parameter “Operation HEAT/COOL after bus recovery”

With the parameter, the reaction after bus voltage recovery is set. Options:

Unchanged

HEAT

COOL

Unchanged: After bus voltage recovery, the state that existed before bus voltage failure is re-established.

HEAT: After bus voltage recovery, the heating state is set.

COOL: After bus voltage recovery, the cooling state is set.

5.6.1.4 2 Control value/2-pipe with switch obj.

The 2-pipe system has two control objects act on the heating valve; the cooling valve is not used. And toggle between the heating and the cooling is implemented via a separate communication object.

Parameter “Toggle by separately object, Valve COOL not usable”

The parameter serves as a remark that between the heating and the cooling can be toggled via a separate object, and the valve COOLING is not usable. The communication objects in conjunction with the cooling valve, e.g. status, forced operation or valve purge are not effective.

Valve HEATING/ COOLING

Via the communication object “HVAC-General HEAT” or “HVAC-General COOL” the heating valve and the fan can be controlled.

Toggling between heating and cooling is implemented by the separate communication object “HVAC-General Toggle HEAT/COOL”. The control values is updated via the object “HVAC-General HEAT” or “HVAC-General COOL”. If the current status is heating and the control value of 50%, when the status is toggled to cooling, the valve is still adjusted according to 50% until the object “HVAC-General COOL” receives a new control value. During heating, the control value that is received via the object “HVAC-General COOL” is invalid, and vice versa.

i.e. the switch over between heating/cooling should occur exclusively with the respective thermostat. Here only heating or cooling are active, dependent on the last active received control value.

When the object “HVAC-General HEAT” or “HVAC-General COOL” receives a control value or the object “HVAC-General Toggle HEAT/COOL” receives a toggle value, the monitoring time is re-started. After bus voltage recovery if the heating and the cooling is toggled, the fault is also reset instead of maintain. **Note: If the received control value is invalid, the fault is not reset.**

In the case of the valve control mode “Continuous, PWM”, output S is effective.

In the case of the valve control mode “3 point, open and close”, output R is used to close the valve (100% → 0%), output S is used to open the valve (0% → 100%).

Parameter “Operation HEAT/COOL after bus recovery”

With the parameter, the reaction after bus voltage recovery is set. Options:

Unchanged

*HEAT**COOL*

Unchanged: After bus voltage recovery, the state that existed before bus voltage failure is re-established.

HEAT: After bus voltage recovery, the heating state is set.

COOL: After bus voltage recovery, the cooling state is set.

Parameter “Object value for ‘Toggle HEAT/COOL obj.’ ”

With the parameter you set the object value used to toggle between heating and cooling. Options:

*0**1*

0: As soon as a telegram value 0 is received, heating is activated and cooling is deactivated.

1: As soon as a telegram value 1 is received, heating is activated and cooling is deactivated.

5.6.1.5 2 Control value/4-pipe

The 4-pipe system has two control objects, one act on the heating valve, and other one act on the cooling valve. The cooling valve is not used. And toggle between the heating valve and the cooling valve is implemented via automatically.

Parameter “Toggle automatically”

The parameter serves as a remark that between the heating and the cooling can be toggled via automatically.

Valve HEATING/ Valve COOLING

Via the communication object “HVAC-General HEAT” or “HVAC-General COOL” the heating /cooling valve and the fan can be controlled.

The heating valve is controlled via the communication object “HVAC-General HEAT”. The cooling valve is controlled via the communication object “HVAC-General COOL”. Toggling between heating and cooling is implemented by updating the control values, the heating/cooling status is then set accordingly. I.e. the switch over between heating/cooling should occur exclusively with the respective thermostat. Here only heating or cooling are active, dependent on the last active received control value.

When the object “HVAC-General HEAT” or “HVAC-General COOL” receives a control value, the monitoring time is re-started. After bus voltage recovery if the heating and the cooling is toggled, the fault is also reset instead of maintain.

During the heating, the communication object that is used for disable the cooling is unusable, so the value that it receives is invalid, and vice versa.

In the case of the valve control mode“Continuous, PWM”, output S is effective in the heating operation; output U is effective in the cooling operation.

In the case of the valve control mode “3 point, open and close”, if the heating operation, output R is used to close the valve (100% →0%), output S is used to open the valve (0% →100%). If the cooling operation, output T is used to close the valve (100% →0%), output U is used to open the valve (0% →100%).

Parameter “Operation HEAT/COOL after bus recovery”

With the parameter, the reaction after bus voltage recovery is set. Options:

Unchanged
HEAT
COOL

Unchanged: After bus voltage recovery, the state that existed before bus voltage failure is re-established.

HEAT: After bus voltage recovery, the heating state is set.

COOL: After bus voltage recovery, the cooling state is set.

Note: After download parameters, the heating state is set by default.

5.6.2 Parameter window“OUTPUT R,S---HEATING:Continuous, PWM”

In this parameter window, all settings for the valve heating are undertaken. The follow parameters appear if the valve control mode “Continuous, PWM” has been selected. This control type is suitable for driving two-wire valve that one end is connected to the output S (U if cooling valve) and the other end is connected to the N₂ of the power supply.

With PWM, the valve is operated as with 2-point control exclusively in the positions fully opened and fully closed. The valve opening is calculated according to the control value and a cycle time. For example, the room controller receives a control value 20% at a cycle time of 15min, the valve will be opened for 3 minutes and closed for 12 minutes. The control value 60% results in a valve opening time of 9 minutes and closing time of 6 minutes. The control value for heating or cooling is provided by a thermostat. PWM control type as follows:

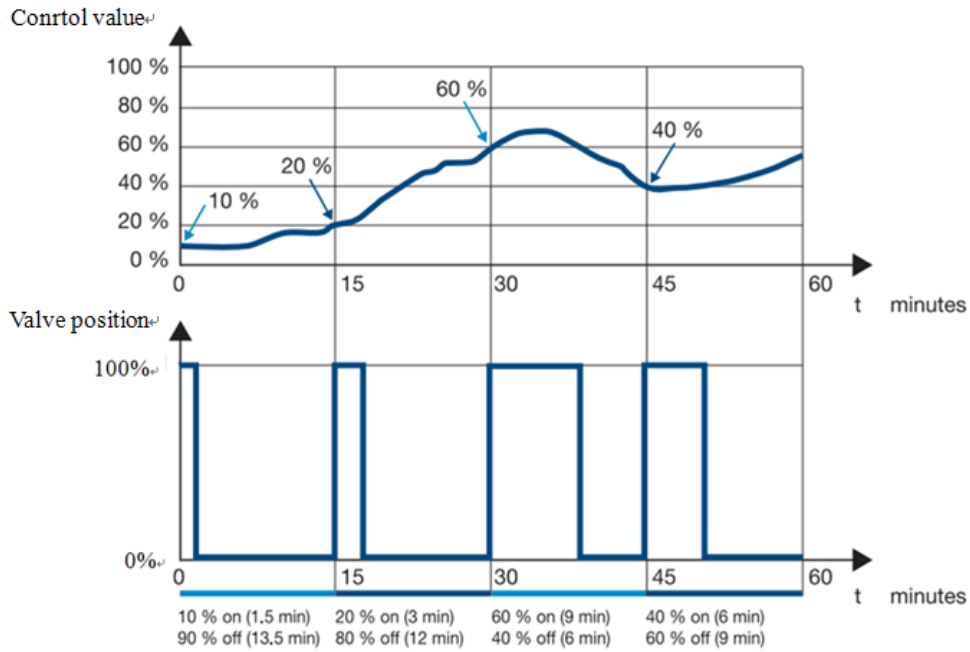

With PWM, a relatively accurate control of the temperature can be achieved without any resulting overshoots. Simple, attractively-priced control valves can be used. The positioning frequency of the control valve is relatively high. PWM can be used with the room controller in conjunction with electro-thermal valve drives.

All settings parameters for the PWM as follows:

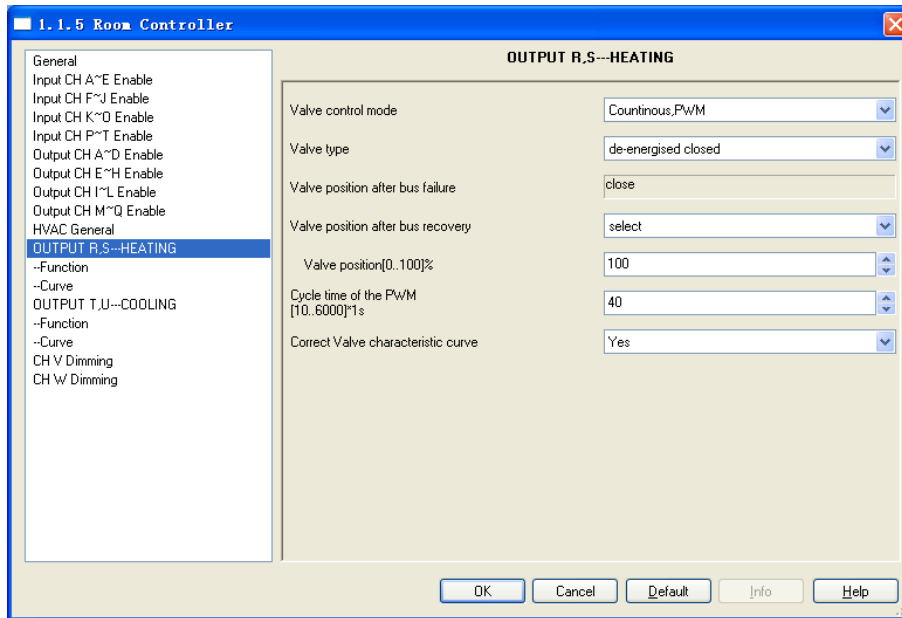

Fig. 5.35 parameter window “HEATING:Continous, PWM”

Parameter “Valve type”

With this parameter, the valve type for the connected valve is set. Options:

Normally opened

Normally closed

Normally opened: If no current flows in the control, circuit the valve is opened. The valve is closed as soon as current flows in the control circuit.

Normally closed: If no current flows in the control, circuit the valve is closed. The valve is opened as soon as current flows in the control circuit.

Parameter “Valve position after bus failure”

This parameter serves as a remark that the valve position after bus voltage failure.

If the valve type is Normally opened, the valve remains opened at bus voltage failure.

If the valve type is Normally closed, the valve remains closed at bus voltage failure.

Parameter “Valve position after bus recovery”

With this parameter, the position of the valves after bus voltage recovery can be set. Options:

Unchanged

Select

Unchanged: After bus voltage recovery, the valve position before bus voltage failure is remained.

Select: the follow parameter appears.

——**Parameter “Valve position [0…100%]”**

With this parameter, the position of the valves after bus voltage recovery can be set as a percentage. Option:
0…100%

If the valve characteristic curve correction is enabled, the valve position after bus voltage recovery is as a control value to correct.

If there is a higher priority operation before bus voltage failure, then after bus voltage recovery the operation will be retained. For example, the operation is valve purge before power off, then after bus reset the operation is continued and the purge duration time is re-started. The valve position via the parameter setting is executed after the priority operation has been completed. The cycle time of the PWM is also re-time after bus voltage recovery.

Note: the download is not as a bus reset processing, and the valve position is adjusted to 0%.

The priority of various operations refer to the end of the section 5.6.3.

Parameter “Cycle time of the PWM [10…6000]*1s”

This parameter is used to set the cycle time of the PWM control. If the longer the time, the positioning frequency is lower, the shorter the time, the positioning frequency is higher. Option: 10...6000s

Parameter “Correct Valve characteristic curve”

The parameter sets whether to enable the valve characteristic curve correction. Options:

- Yes
- No

Yes: the parameter window“Curve” appears, fig.5.37.

5.6.2.1 Parameter window“HEATING: Function”

Some additional functions can be enabled in the parameter window -- Function.

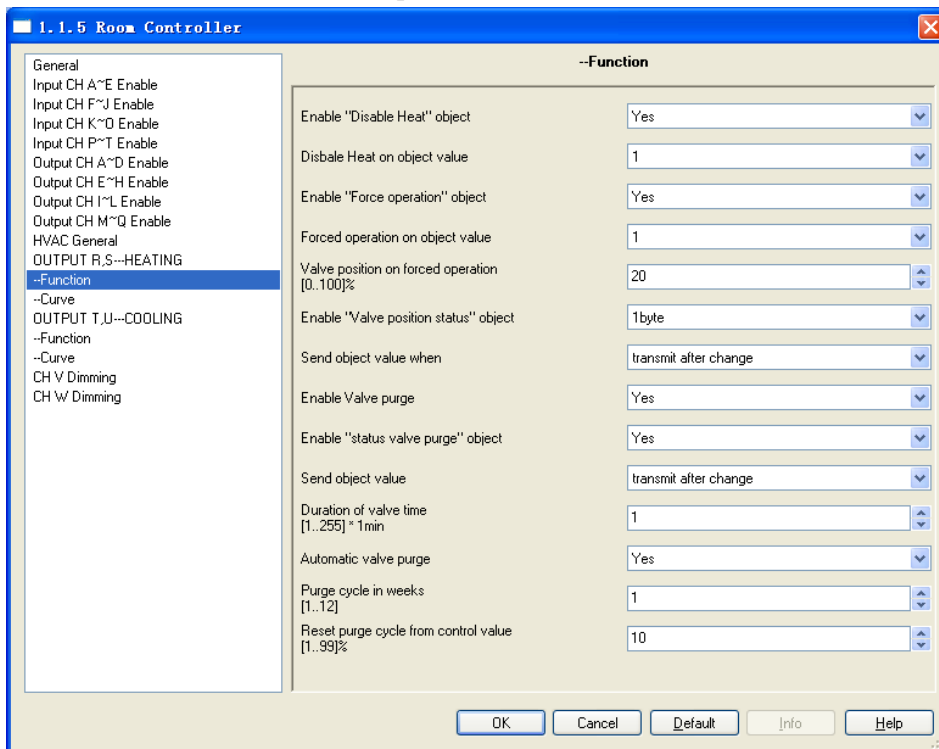

Fig. 5.36 parameter window “HEATING: Function”

Parameter “Enable ‘Disable Heat’ object”

Options:

- Yes
- No

Yes: The 1 bit communication object“HEAT Disabled” is enabled and is used for blocking the heating valve.

And the following parameter appears:

Parameter “Disable Heat on object value”

This parameter sets the object value used to block the heating valve. Options:

0
1

1: the heating is disabled by a telegram value 1 of the object “HEAT Disabled” and is enabled by value 0.

0: the heating is disabled by a telegram value 0 of the object “HEAT Disabled” and is enabled by value 1.

Note: when the heating is disabled, the valve position is adjusted to 0%, when it is enabled again, the operation before disable is restored immediately. During disable, the cycle time of PWM is interrupted, but once again enabled, the time will continue.

In addition, during disable the received telegram is valid, and is executed after enable again, if there is special case, please refer to the chapter 5.6.1 description of piping systems.

Parameter “Enable ‘Forced operation’ object”

Options:

No
Yes

Yes: The 1 bit communication object “HEAT Forced operation” is enabled and can thus be forced operated. And the following two parameters appear:

——**Parameter “Forced operation on object value”**

This parameter sets the object value used to forcibly operate the valve. Options:

0
1

1: the Forced operation is activated by a telegram value 1 of the object “HEAT Forced operation” and is cancelled by value 0.

0: the Forced operation is activated by a telegram value 0 of the object “HEAT Forced operation” and is cancelled by value 1.

——**Parameter “Valve position on force operation [0…100%]”**

With this parameter, the forced operation of the valve position is set. Option: 0…100%

If the valve characteristic curve correction is enabled, the valve position on force operation is as a control value to correct.

Parameter “Enable ‘Valve position status’ object”

Options:

No

Ibit
Ibyte

1bit: the follow two parameters appear, a 1 bit communication object“HEAT Valve position status ” also appears, which is used to indicate the valve status.

——**Parameter “Send object value when”**

The parameter defines how to respond the valve status. Options:

- No reply*
- Transmit after change*
- Always respond, after read only*

With the “no reply”, the status is not sent, and the object “HEAT Valve position status” value is always 0.

With the “transmit after change”, the status is send after a change or a request.

With the “always respond, after read only”, the status is only sent after a request.

——**Parameter “Object value with valve position >0”**

Options:

- 0*
- 1*

In “Continues control, PWM”, the status information as follows:

The valve types	options	Desctiption
<i>Normally opened</i>	0	If no current flows in the control circuit (valve opened), the object “HEAT Valve position status” sends a telegram “0”; if current flows (valve closed) with telegram “1”.
	1	If no current flows in the control circuit (valve opened), the object “HEAT Valve position status” sends a telegram “1”; if current flows (valve closed) with telegram “0”.
<i>Normally closed</i>	0	If current flows in the control circuit (valve opened), the object “HEAT Valve position status” sends a telegram “0”; if no current flows (valve closed) with telegram “1”.
	1	If current flows in the control circuit (valve opened), the object “HEAT Valve position status” sends a telegram “1”; if no current flows (valve closed) with telegram “0”.

In “3 point, open and close”, if the valve position>0, the object “HEAT Valve position status” sends a telegram

“1”; if the valve position is fully closed(=0) with telegram “0”.

1byte: the follow parameter appears, a 1 byte communication object“HEAT Valve position status ” also appears, which is used to indicate the valve position status.

——Parameter “Send object value when”

The parameter defines how to respond the valve position status. Options:

No reply

Transmit after change

Always respond, after read only

With the “no reply”, the status is not sent, and the object “HEAT Valve position status” value is always 0.

With the “transmit after change”, the status is send after a change or a request.

With the “always respond, after read only”, the status is only sent after a request.

Note: In “3 point, open and close”, the valve position status is updated when the valve position is changed.

In “Continues control, PWM”, the valve position status is also updated when the valve position is changed.

So when the device receives a new control value, the valve position is not changed immediately until last PWM valve adjustment has completed. Because only when last PWM valve adjustment has completed, the valve position adjustment is carried out according to the new control value, even if there is different priority operation (except tthe disable heating/cooling operation and the valve purge are carried out immediately. But when the heating/cooling is re-enabled or the valve purge has completed, the last PWM valve adjustment is still continue, and then enter a new adjustment when it has complated).

Parameter “Enable Valve purge”

Options:

Yes

No

Yes: a 1bit communication object“HEAT Trigger valve purge”is enabled, which is used to trigger the valve purge operation. If there is not a higher priority operation, it will be executed immediately after trigger. The follow parameters appear.

——Parameter “Enable ‘status valve purge’ object”

Options:

Yes

No

Yes: a 1 bit communication object“HEAT Status valve purge” is enabled, which is used to indicate the valve

purge status. And the follow parameter appears:

— — **Parameter “Send object value”**

Options:

No reply

Transmit after change

Always respond, after read only

With the “no reply”, the status is not sent, and the object “HEAT Status valve purge” value is always 0.

With the “transmit after change”, the status is send after a change or a request.

With the “always respond, after read only”, the status is only sent after a request.

——**Parameter “Duration of valve time[1…255]*1min”**

The time duration for the valve purge is set with this parameter. In this time the valve is fully opened, i.e. the valve position for purging is always 100%. When the time has elapsed, the state before the purge is re-established.

Option: 1…255min

If the heating/cooling is disabled during valve purge, the purge is interrupted, and the time is also interrupted, but the heating/cooling is restored, the purge will be continued and the time is extended.

——**Parameter “Automatic valve purge”**

Options:

Yes

No

Yes: the following parameters appear:

— — **Parameter “Purge cycle in weeks [1…12]”**

The parameter defines the cycle in weeks for automatic purging. The counter starts to run when the parameter is downloaded (except “3 point, open and close”, it is started from the valve position is determined). When the time has passed, the purging is triggered. The time is reset as soon as purging is completed. This can occur either via automatic purging or via the communication object “HEAT Trigger valve purge” (If during purging, the purging process is interrupted, e.g. via the object, the purging duration time is not reset, but the process has been recorded, and when the cycle for automatic purging is arrived, the process continue to be completed.). The bus voltage failure time is not considered. After bus voltage recovery, the cycle continues. But the timer is 2 min as a unit, that is, if the timing is not 2min before bus voltage failure, it will not be accumulated to the cycle. For example, the timed 5min before bus power off, then after bus reset, the recorded time is only 4min.

Option: 1…12

— — Parameter “reset purge cycle from control value [1…99] %”

Hereby the purge cycle from the set control value is reset. If the current valve position is greater than the parameterized value, the purge cycle is reset.

5.6.2.2 Parameter window “HEATING:Curve”

The parameter window “Curve” is visible if in parameter window 5.35 the parameter “Correct Valve characteristic curve” has been selected with the option yes, which is used to correct the valve characteristic curve.

Parameter description as follows:

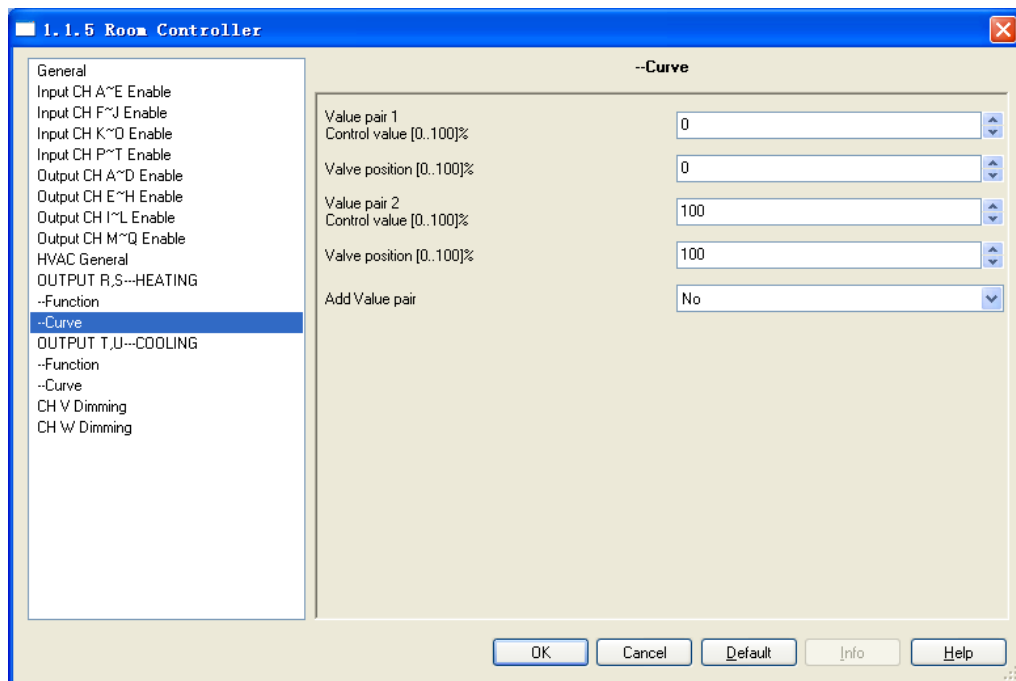

Fig. 5.37 parameter window “HEATING: Curve”

Value pair 1

Parameter “Control value [0…100] %”

The parameter sets the lower limit control value of the curve. Option: 0…100%

Parameter “Valve position [0…100] %”

The parameter sets the lower limit valve position of the curve. Option: 0…100%

Value pair 2

Parameter “Control value [0…100] %”

The parameter sets the upper limit control value of the curve. Option: 0…100%

Parameter “Valve position [0…100] %”

The parameter sets the upper limit valve position of the curve. Option: 0…100%

Assume that the lower limit control value is 10%, the lower limit valve position is 20%, the upper limit control value is 70% and the upper limit valve position is 80%, there is shown below the valve characteristic curve:

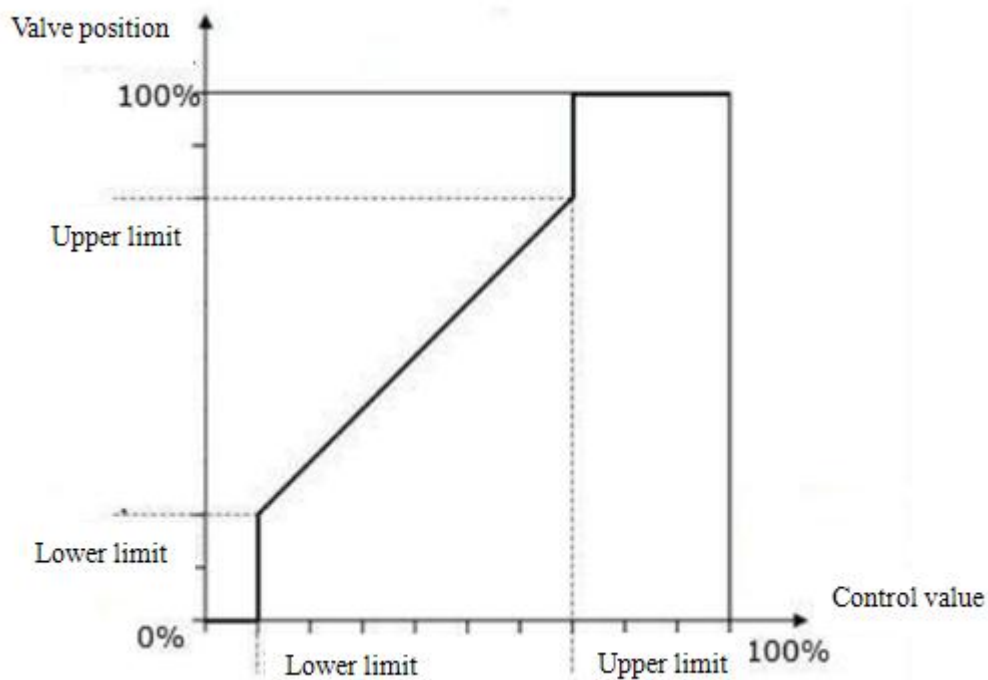

When the control value is less than 10%, the valve is fully closed; the control value is greater than 70%, the valve is fully opened; the control value is between 10% to 70%, the valve opening range is 20% to 80% and the valve control is a linear curves. The positioning frequency of the valve drive may be reduced by limitation of the active valve opening range and the control value, for example, a valve movement with a minimal heating or cooling requirement can be avoided. And the service life of the valve can be increased by the function, and the valve noise at low flows can be reduced, because many valves emit an annoying whistling sound at low flows. However, a reduced positioning frequency will also impair the accuracy of the temperature control.

In addition, the valve characteristic curve through the following parameters can be further corrected.

Parameter “Add Value pair”

Options:

Yes

No

Yes: a further value pair can be set. The value pair 1 can be further corrected by the Value pair 3.

——**Value pair 3**

Parameter “Control value [0…100] %”

Option: 0…100%

Parameter “Valve position [0…100] %”

Option: 0…100%

Parameter “Add Value pair”

Options:

Yes

No

Yes: a further value pair can be set. The value pair 2 can be further corrected by the Value pair 4.

——**Value pair 4**

Parameter “Control value [0…100] %”

Option: 0…100%

Parameter “Valve position [0…100] %”

Option: 0…100%

Note: the control value and valve position of Value pair 1 must be less than Value pair 2 settings, and the value pair 3 settings must be less than the value pair 4 settings. The value pairs 1 and 2 are used to correct the valve characteristic curve. While the value 3 and 4 are used to correct further the corrected curve.

If the control value is entered as a percentage, the corrected valve characteristic curve will be a little deviation, typically deviation within 2%.

5.6.3 Parameter window“OUTPUT R,S---HEATING:3 point, open and close”

The follow parameters appear if the valve control mode “3 point, open and close” has been selected. This control type is suitable for driving 3-point valve that one end is connected to the output R, S (T, U if cooling valve) and the other end is connected to the N2 of the power supply.

With “3 point, open and close”, a control value is calculated, based on the target temperature and the actual temperature, and is the most precise form of temperature control. The valve is brought to a position, which complies with the calculated control value, for example, the control value of 20%, and then the valve position will be opened to 20% and stopped. With this method, the valve can be fully opened, fully closed and even positioned in every intermediate position, and the position frequency of the valve drive can be kept low.

The control value for heating or cooling is provided by a thermostat. “3 point, open and close” control type as follows:

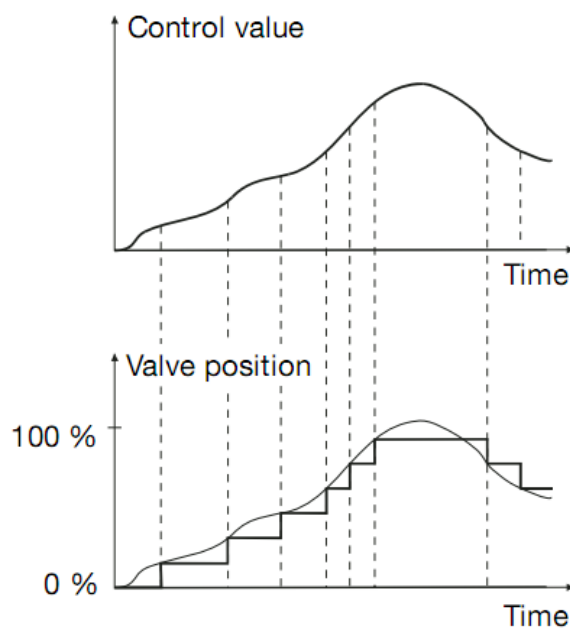

All settings parameters for the “3 point, open and close” as follows:

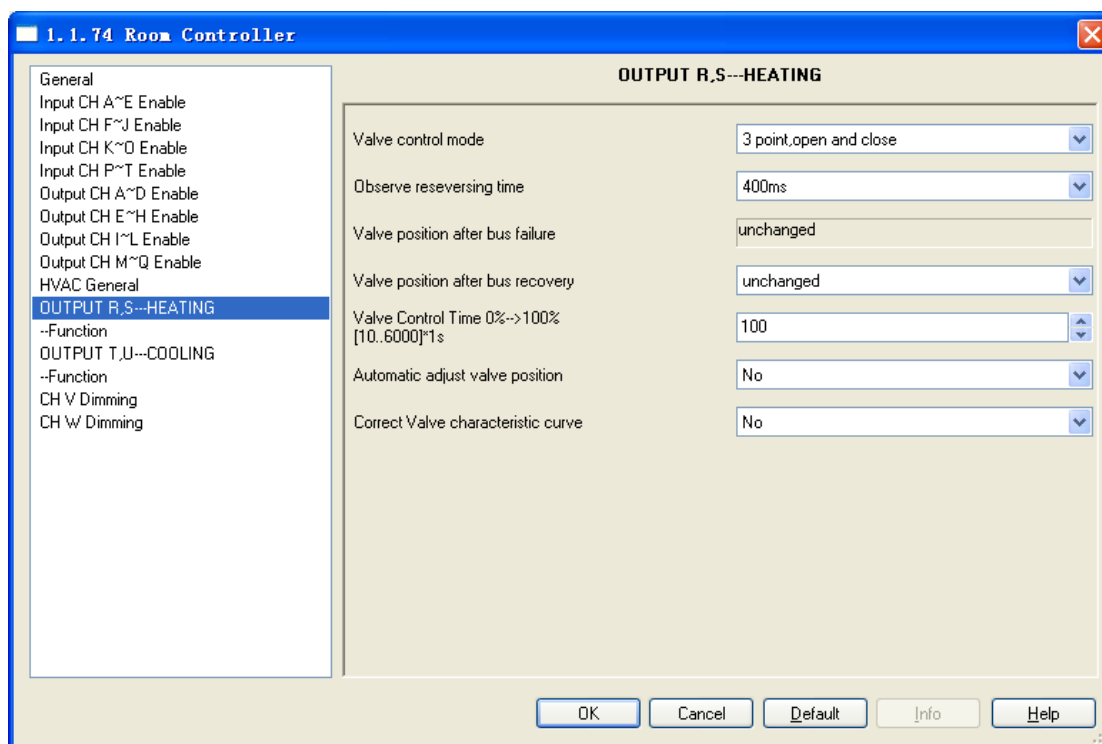

Fig. 5.38 parameter window “HEATING:3 point, open and close”

Parameter “Observe reversing time”

A reversing pause time is set via this parameter. It is helpful to protect the valve. Options:

0/100ms/200ms/.../1s/1.2s/1.5s

This time is a technical data of the valve and it is always taken into consideration.

Parameter “Valve position after bus failure”

The parameter serves as a remark that the valve remains unchanged at its position with a bus voltage failure.

Parameter “Valve position after bus recovery”

With this parameter, the position of the valves after bus voltage recovery can be set. Options:

Unchanged
Select

Unchanged: After bus voltage recovery, the valve position before bus voltage failure is remained. If the valve action has not completed before bus voltage failure, it will be executed continually after bus voltage recovery until completed.

Select: the follow parameter appears.

Note: *the download is not as a bus reset processing, and the valve position is adjusted to 0%. Only when the valve position to 0%, the valve position is determined, then the further operation can be carried out. For example, the parameterized valve position is 50% after bus reset, but if the valve position is not determined before bus*

power off, then after bus reset the valve is firstly adjusted to 0%, then to 50%. If the position is determined, the valve is directly adjusted to 50%.

In 3 point, open and close, the cycle for automatic purging is started from the valve position is determined.

——Parameter “Valve position [0…100%]”

With this parameter, the position of the valves after bus voltage recovery can be set as a percentage. Option:
0…100%

Parameter “Valve control time 0%→100% [10…6000]*1s”

With the parameter, a time that the connected valve requires to move from position 0% (valve fully closed) to position 100% (valve fully opened) can be set, that is the total travel time. Options: 10…6000s

For example, the time is 180s, the current valve position is at 20%, the target position is 60%, then the travel time of the valve will need 72s from 20% to 60%.

The time should be taken from the technical data of the valve.

Parameter “Automatic adjust valve position”

With this parameter enable automatically adjust valve position. Options:

Yes

No

*Yes:*The following parameter appears.

This function is mainly used to correct the valve position, for example, the valve is not fully opened or closed after long working hours due to various reasons lead to the valve position slight inaccuracies, such temperature, aging of the device etc. So it needs to be repositioned via the function.

——Parameter “Number of valve controls up to adjustment [1…65535]”

With this parameter, the number of operations (valve controls), after which automatic adjustment is undertaken, can be set. Options: 1…65535

When the automatic adjustment is executed, the valve is fully closed, and the closing position is exceeded by 5% of the total time, max. One minute.

Assuming that the parameterized value is 100, when the number of valve controls arrived to 100, if the valve is adjusted to the opening direction on the 101st adjustment, then the automatic adjustment is not executed, if to the closing direction, the automatic adjustment will be executed, and the valve is adjusted to the position 0%, and then adjusted to the target position. For example, on the 100st the valve position is 50%, if the 101st the valve position is 60%, the valve position is adjusted directly to 60% and do not execute an automatic adjustment until a

reversal control value is received. If the 101st the valve position is 40%, an automatic adjustment is undertaken and the valve is adjusted to the position 0%, and then adjusted to the target position 40%.

After the automatic adjustment, the adjustment counter is set to 0. The adjustment counter is incremented by 1 every time the valve stops (the positioning adjustment after parameter download is not included). The automatic adjustment can not be interrupted, except there are higher priority operations and the adjustment will be performed later.

In the case of 2-pipe system, the adjustment counter does not differentiate between the heating and the cooling.

The number should be taken from the technical data of the valve manufacturer.

Parameter “Correct Valve characteristic curve”

The parameter sets whether to enable the valve characteristic curve correction. Options:

Yes

No

Yes: the parameter window “Curve” appears, fig.5.37.

The priority of various operations for HVAC system:

Inialization (after parameter download) →disable heating/cooling →forced operation →purging valve →valve automatic adjustment(only apply to 3point,open and close) →fault monitoring, bus reset or general operation(general operation is triggered via objects “HVAC-General HEAT/COOL”, “HVAC-General HEAT” or “HVAC-General COOL”)

The following applies with priority operations:

1, During fault, if heating/cooling is disabled, the fault status is still remained, except a control value is received via objects “HVAC-General heat/cool”, “HVAC-General heat” or “HVAC-General cool” or switchover the heating/cooling. During disable heating/cooling, the valve position is 0% and can be adjusted. And the fault monitoring is only used to monitor telegrams from the objects “HVAC-General heat/cool”, “HVAC-General heat” or “HVAC-General cool”. The valve purging status is similar, during purging if there are higher priority operations to occur, the status is also remained, and the purging will be continued to perform after high priority operations end.

2, Forced operation, fault monitoring, bus reset and general operation need to consider curve correction, other operations regardless of the curve.

3, If more than one operation is active at the same time, the valve will be adjusted in accordance with their

priority. For example, currently there are the forced operation, valve purging and general operation, when the forced operation is cancelled, the valve purging will be performed, when the valve purging has been completed, the general operation will be performed.

5.6.4 Parameter window“OUTPUT T,U---COOLING”

The parameter settings of valve cooling are the same with the valve heating. Please refer to description of the parameters in the valve heating chapter.

5.7 Dimming outputs (V~W)

There are 2 outputs. Each output can be set separately, and parameters and objects which are assigned to each output are the same. Using output V as an example described.

5.7.1 Parameter window“Dimmer CHX Active”

The parameter window of “Dimmer CH X active” can be seen in Fig. 5.30, which activate or deactivate the dimming output X (X=V,W).

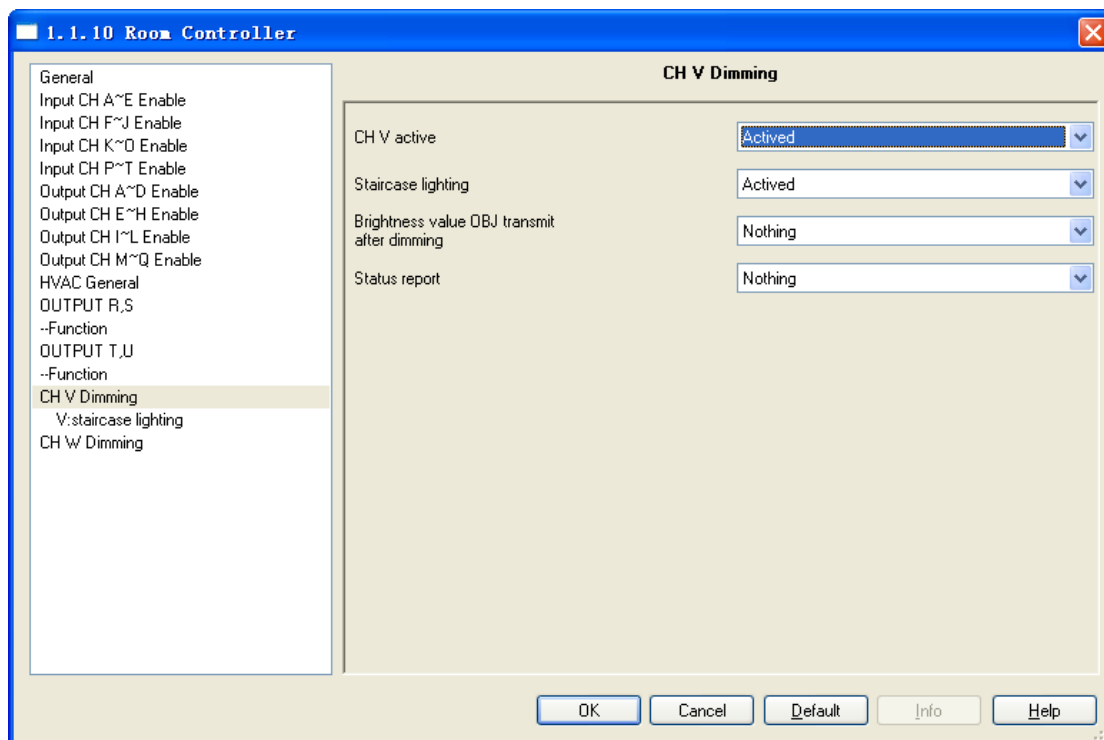

Fig. 5.30 parameter window “Dimmer CH V~W Active”

Parameter “CHX Active”

Options:

- Activated*
- Deactive*

If selecting “Activated”, the output will be enabled, and the follow parameters will be visible, which can set the working mode, the current brightness status and the switch status report. It will become null with “Deacitved” selection.

Parameter “Staircase lighting”

Options:

- Activated*
- Deactivated*

It is in the status of staircase lighting control with “Activated” and in the general dimming control with “Deactive”.

2 operation modes (main function) per output:

——**General dimming**

This mode is mainly used to control general lighting system, which can set the output time and the brightness value of the dimmer, dim darker or brighter with the function of “relative dimming”, and also call the preset

brightness values from the scene function, until dim to the required brightness.

— **Staircase lighting**

The mode is mainly used to control the staircase lighting. Switch ON the staircase lighting and switch OFF automatically after a certain period, or switch OFF by manually. The staircase lighting can be also switched on for a long time via permanent on, but the case need to switch off by manually.

Parameter “brightness value OBJ. transmit after dimming”

This function is used to report the latest brightness value. When enable this function, it will send a brightness value to the BUS no matter what happen to make the brightness value changed. Options:

Nothing

Transmit new brightness

It will not send any report of the current brightness value with “Nothing”. And with “Transmit new brightness” the object “brightness status” will send a brightness value to the BUS to report the current brightness value when the device receives a telegram to regulate the brightness, no matter what happens to make the brightness value changed or no changed.

Note: if selected “transmit new brightness”, the object “Brightness status X” and object “Brightness X” cannot be linked together by a same group address, or lead to the device internal loopback, and enter into endless loop, to make the bus system crash.

Parameter “Status report”

This function defines whether report the switch status to the BUS when the value of object “switch status” is changed. Send “1” to the BUS when the current brightness value is greater than 0; send “0” when the value is equal to 0. Options:

Nothing

It's new status

It will not send any report of the current switch status with “Nothing”. And send a status report of switch to the BUS if switch changed with “It's new status”.

5.7.2 General dimming

5.7.2.1 Parameter window “X: dimming general”

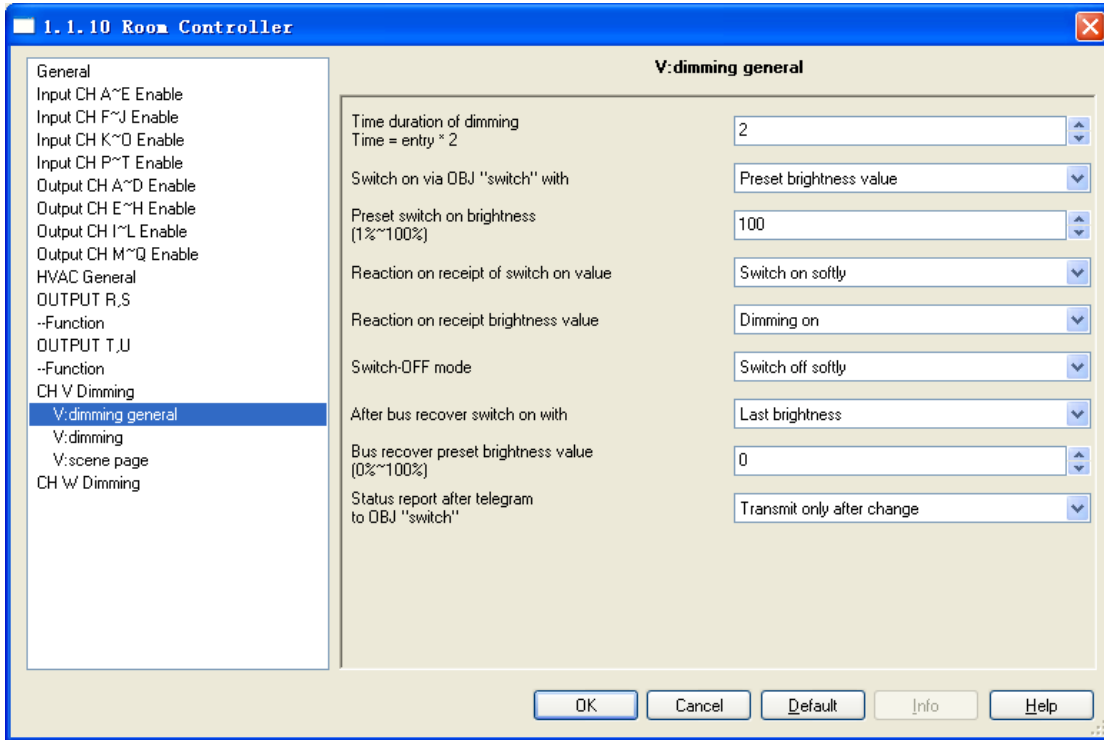

Fig. 5.31 parameter window “X: dimming general”

Parameter “time duration of dimming time=entry*2”

It is used to set the duration time of dimming. No matter the lamp is switched on or off via brightness or switch, when choosing dimming on or dimming off in the follow parameters “reaction on receipt of brightness value” and “reaction on receipt of switch on value”, the time is equal to this input value multiply 2 seconds, and the maximum input time is 255s.

Parameter “Switch on via OBJ “switch” with”

It is used to select the brightness value is the last one or the preset one when using the switch mode to switch on the luminaries. Options:

- Preset brightness value*
- Last brightness value*

The option “Preset brightness value” means the brightness value is the preset value when switching on the luminaries by switch mode. When the brightness low threshold value is greater than the switch preset value, the brightness value of the luminaries is the low threshold value after switching on; when the switch preset value is greater than the high threshold, the brightness value is the high threshold one after switching on. The high and low

threshold of the brightness is shown in the parameter window “X: dimming”, see Fig. 5.32.

The option “Last brightness value” means the brightness value is the last brightness value which is not equal to 0. If the first behavior of switching on the luminaries in switch mode after the BUS reset, and the luminaries after BUS reset are off, so the brightness value is the default brightness value 128; Other cases, the brightness value is the last brightness value which is not equal to 0 on switching mode.

Parameter “Preset switch on brightness(1%~100%)”

It is used to set the brightness value when switch on the luminaries in switch mode, with the setting range 1%~100%.

Parameter “reaction on receipt of switch on value”

It shows the duration time to switch on the luminaries from brightness 0 to 100% via the switch mode. Options:

Dimming on
Switch on softly

The option “Dimming on” means the time of dimming is the input time multiplies 2 via switch. Then option “Switch softly” means the default dimming time is 4s.

The input time is defined in the parameter “time duration of dimming time=entry*2”.

Parameter “reaction on receipt brightness value”

It is used to set the duration time to switch on the luminaries from brightness 0% to 100% or off the luminaries via the brightness dimming mode. Options:

Dimming on
Switch on softly

The option “Dimming on” means the brightness dimming time is the input time multiplies 2. Then option “switch on softly” means the default dimming time is 4s.

The input time is defined in the parameter “time duration of dimming time=entry*2”.

Parameter “Switch-off mode”

It shows the duration time to switch off the luminaries from brightness 100% to 0% via the switch mode. Options:

Dimming off
Switch off softly
Switch off instantly

The option “Dimming off” means the duration time of switch off is the input time multiplies 2. The option “switch softly” means the default time is 4s. The option “switch off instantly” means the luminaries are switch off immediately.

The input time is defined in the parameter “time duration of dimming time=entry*2”.

Parameter “After bus recover switch on with”

The parameter defines the behavior after the BUS reset is the brightness value before power off or the preset value. Options:

Preset brightness value

Last brightness value

The option “Preset brightness value” means the brightness value after the BUS voltage recovery is the preset brightness value in the parameter “bus recover preset brightness value (0%~100%)”. If the input preset value is smaller than the low threshold, the value after the BUS voltage recovery is the low threshold; if the input preset value is greater than the high threshold, the value after the BUS voltage recovery is the high threshold. The high and low threshold values are shown in the parameter window “X: dimming”, see Fig. 5.32.

The option “Last brightness value” means the brightness value is the last value before power off after BUS voltage recovery. It also carries out a bus reset operation after downloading the parameters. Note that the program can not be treated as a power off, so there is no need to focus on the brightness value before programming, but the value before the bus power off. (Power off of the bus need more than 4s, otherwise the last brightness value may not be saved successfully.)

Parameter “Bus recover preset brightness value(0%~100%)”

It is used to set the brightness value after the bus voltage recovery, and the range is 0%~100%.

Parameter “status report after telegram to obj “switch” ”

It is a backup parameter, do not care it.

5.7.2.2 Parameter window “X: dimming”

Parameter window “X:dimming” can be shown in fig. 5.32. Here can set the parameters of the brightness dimming and relative dimming.

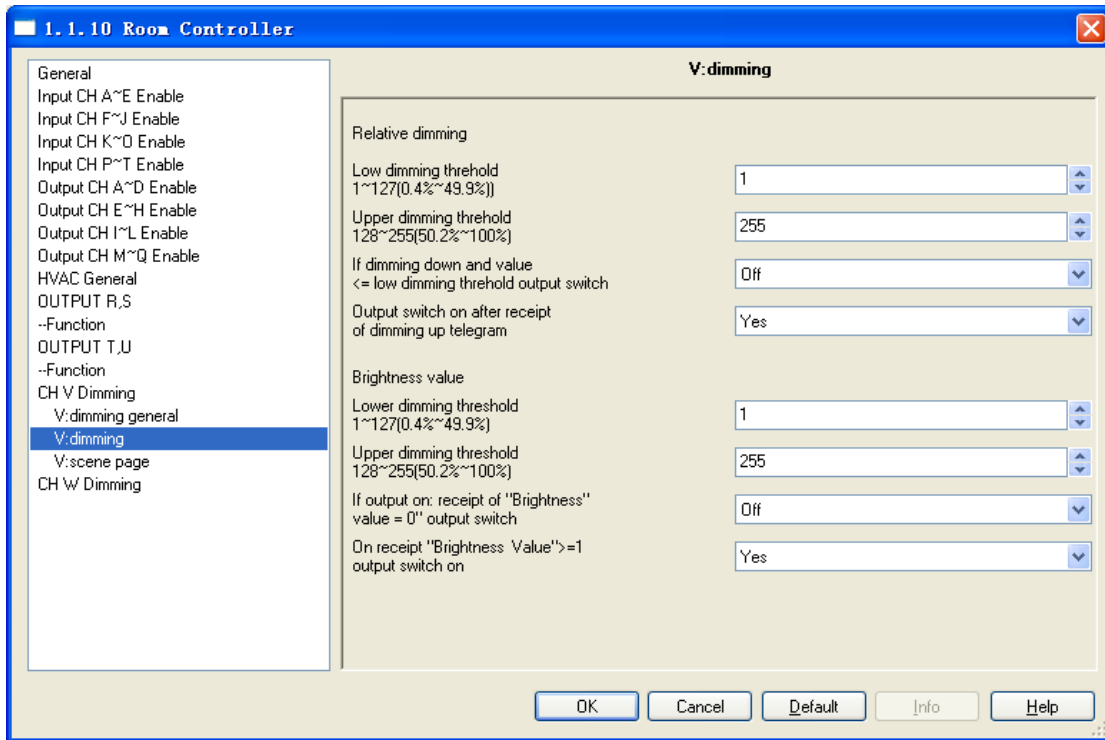

Fig. 5.32 parameter window “X: dimming”

Relative dimming

Parameter “low dimming threshold 1~127(0.4%~49.9%)”

This parameter defines the low threshold value of the relative dimming. When the brightness is smaller than the low threshold, it is not allowed to dim DOWN, only to dim UP, the range is 1~127 (0.4%~49.9%). Supposing the low threshold is 50, if the current brightness value is smaller than 50, so it is not allowable to dim DOWN until dimming UP to above 50.

Parameter “upper dimming threshold 128~255(50.2%~100%)”

This parameter defines the high threshold value of the relative dimming. When the brightness is greater than the high threshold, it is not allowed to dim UP, only to dim DOWN, the range is 128~255 (50.2%~100%). Supposing the high threshold is 200, if the current brightness value is greater than 200, it is not allowable to dim UP until dim DOWN to below than 200.

Parameter “If dimming down and value <=low dimming threshold output switch”

This parameter defines the action that the brightness is dimmed down to less than or equal to the lower threshold value after relative dimming, whether it will be off or stay in the low threshold value. Options:

- Off*
- To low threshold value*

Supposing the low threshold is 50. If it is “Off”, it will switch off the luminaries when dim DOWN to 50; if it

is “To low threshold value”, the value of the luminaries will remain the same even when dimming DOWN to 50. However, no matter whether it is “Off” or “To low threshold value”, if the low threshold of the relative dimming is smaller than that of the brightness, it will switch off the luminaries automatically when dimming DOWN to the low threshold of the brightness value; if the high threshold of the brightness is less than relative high threshold, it is only possible to dim UP to the high threshold of the brightness. (The high and low threshold value of brightness will limit the total brightness value of the dimmer, see more details in the below description.)

Parameter “Output switch on after receipt of dimming up telegram”

It tells that whether it is possible to switch on the luminaries when receiving the “dimming up” message from relative dimming if the output is 0. Options:

- No*
- Yes*

Supposing the current output is 0. If it is “NO”, the output still remain 0 even when the target receives the message “dimming UP”; if it is “YES”, it will dim the luminaries to the target value when receiving the “dimming up” message. If the value after dimming up is smaller than the brightness low threshold, it will be dimmed to the low threshold directly. If the value after dimming up is greater than the brightness high threshold, it will be dimmed to the high threshold.

Brightness value

The high and low threshold value limits the high and low output value. It is not allowed to change the brightness value if it is beyond the high and low threshold which will be invalid. For example in Fig. 5.32 the value is set as 1~255 that is a whole range. If the low threshold value is set as 50 and the high threshold is 200, the brightness value “210” will be invalid. The luminaries will be dimmed from the low threshold directly when the brightness value goes up from 0; the luminaries will be dimmed from the high threshold directly when the brightness values goes down from 255.

Parameter “low dimming threshold 1~127(0.4%~49.9%)”

This function defines the low threshold of the dimmer, and the range is 1~127. It is going to start dimming from the low threshold. Supposing the current brightness value is 0; the low threshold is 50 and the high threshold is 200. If receiving the message “30”, the brightness value will go to 50 directly without gradual change; if receiving the message “60”, so the brightness value will first go to 50 and then go up to 60 gradually; if the current value is 100 and the target value is 30, so the value will go from 100 to 50 and the brightness value is 50.

Parameter “upper dimming threshold 128~255(50.2%~100%)”

This function defines the high threshold of the dimmer, and the range is 128~255. Supposing the low threshold is 50, and the high threshold is 200. If the target brightness value is greater than 200, it will go to 200 directly.

Parameter “If output on: receipt of “brightness value=0” output switch”

This function defines whether the brightness telegram “0” can switch off the output. Options:

- Off*
- To low threshold value*

The option “Off” means the output is 0 when the brightness value is 0. The option “To low threshold value” means the output is the low threshold when the value is 0.

Parameter “On receipt “brightness value” >=1 output switch on”

This function defines whether object “brightness” can switch on the output when the output is 0. Options:

- No*
- Yes*

The option “No”, if the current output is 0, the dimmer still output “0” after receiving the message of 100. The option “Yes” means the output is the input brightness value when the receiving value is greater or equals to 1; if the input brightness value is smaller than the brightness low threshold, the output is the brightness low threshold.

5.7.2.3 Parameter window “X: scene page”

This parameter shown in Fig.5.33 defines the scene function, totally 15 scenes from 1 to 15. It is able to set 15 scenes simultaneously and call any one of them by control panel when needed.

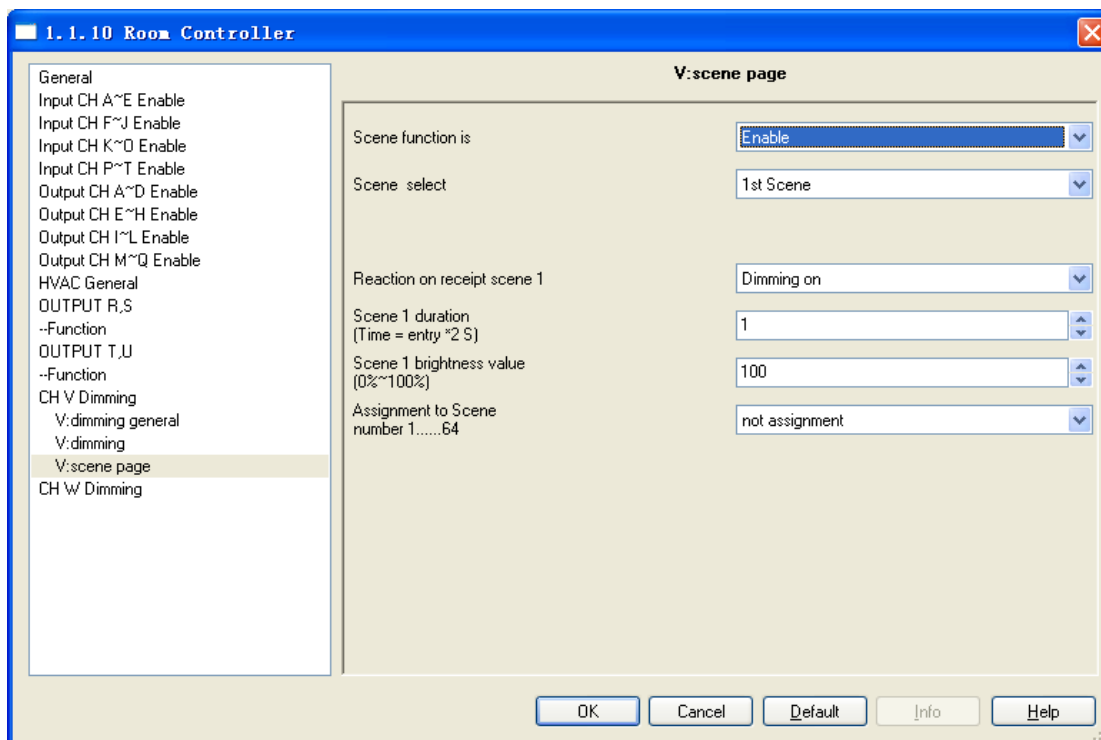

Fig.5.33 parameter window “X: scene page”

Parameter “Scene function is”

The function defines the enable or disable of the scene function. Options:

Enable

Disable

The option “Enable” means it is able to use the scene function of the dimmer X; the window shown in Fig. 5.33 will be displayed after selecting. If there is no need to use the function of scene, so select “Disable” option.

Parameter “Scene select”

This function is used to select a scene and set its brightness value, dimming mode and dimming time. Options:

Scene 1

Scene 2

.....

Scene 15

The setting parameters for each scene are shown as below:

Parameter “Reaction on receipt scene Y”

The function defines the dimming mode of the set scene. Y means the scene that needs setting, 1~15. The Y shown as below has the same meaning. Options:

Dimming on

Switch on softly

The option “Dimming on” means dimming time of the set scene is the set time of the follow parameter “Scene Y duration (time=entry*2s)”: the input time multiplies 2. The option “Switch on softly” means the scene dimming time is the default time “4S”.

Parameter “Scene Y duration (time=entry*2 S)”

This function defines the dimming time of the set scene, which is the input value multiplies 2s; the maximum input time is 255s.

Parameter “Scene Y brightness value (0%~100%)”

This function defines the brightness value of the set scene, with range from 0% to 100%.

Parameter “Assignment to Scene number 1~64”

This function assigns the scene number of the set scene that means the communication object “Scene/save X” will call the scene by the allocated scene number. Options:

Not assignment

Assignment to scene 1

Assignment to scene 2

.....

Note: 1-64 in the parameter setup corresponds to the scene number 0-63 received by the communication object "Scene/Save X". If a scene is modified, the new scene will be stored when power off. After bus voltage recovery, it can be recalled again.

5.7.3 Staircase lighting

It is able to set the parameters of staircase lighting in Fig. 5.34 if the parameter "Staircase lighting" is set to "activated" in fig. 5.30.



图 Fig.5.34

parameter window "X:staircase lighting"

Parameter "Duration of staircase lighting: Base"

Set the time of base: 1.0 s / 2.1 s / ... / 1.1 min / ... / 1.2 h

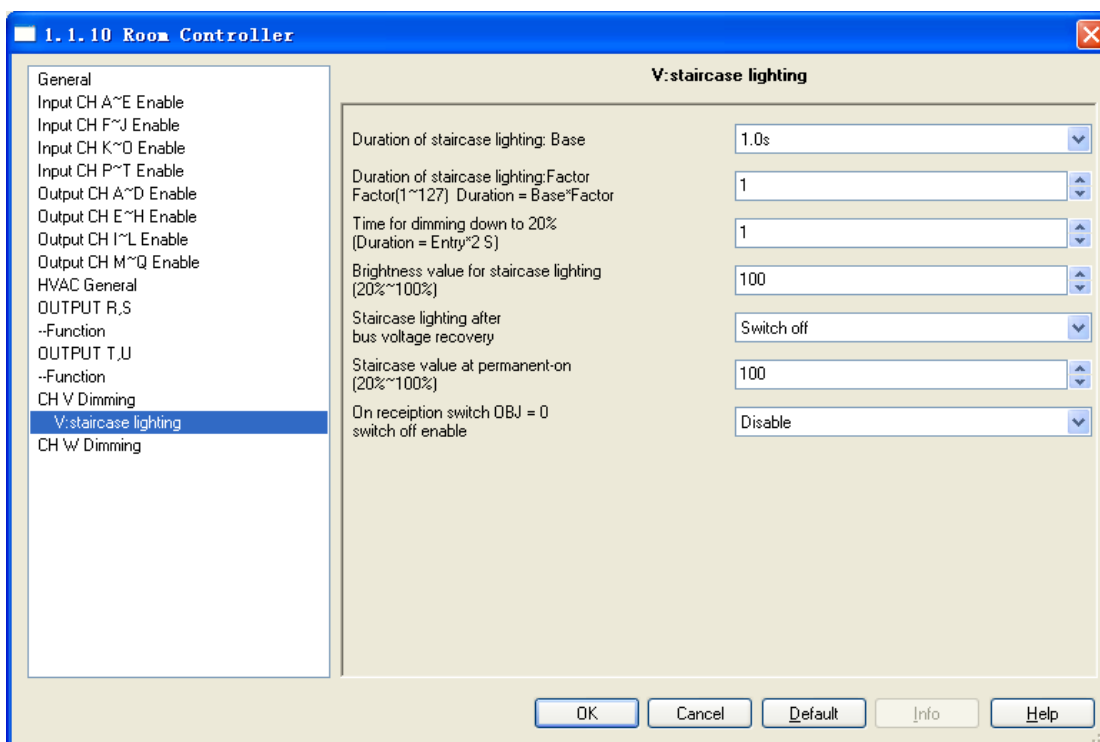
Parameter "Duration of staircase lighting: Factor"

Set the time of factor: 1~127 s

When switch on the staircase lighting by "switch", the ON duration time is: duration=base*factor.

It will switch off the lighting when the brightness goes down to 20% gradually after the ON duration time.

Parameter "Time for dimming down to 20% (Duration=Entry*2)"

This function defines the time that the brightness value of the staircase lighting goes down to 20%:

Duration=Entry*2. The maximum input value is 255s.

The luminaries will be switched off when the brightness value of the staircase goes down to 20%.

In fact the time of dimming off is calculated from 100% to 0%. Such as the brightness decreased from 80% to 20%, the dimming time is $60\% \times (\text{the input time of the parameter} * 2)$.

Parameter “Brightness value for staircase lighting(20%~100%)”

The function defines the brightness value of the staircase when switching on the luminaries by “switch”. Value: 20%~100%.

Parameter “Staircase lighting after bus voltage recovery”

The function defines the status of the staircase lighting after the BUS voltage recovery. Options:

Switch on

Switch off

The option “Switch on” means switch on the staircase lighting after the BUS voltage recovery; the duration time =base*factor. It is to use the parameter “Time for dimming down to 20% (Duration=Entry*2)” to set the DOWN time.

The option “Switch off” means the staircase lighting is off after the BUS voltage recovery.

Parameter “Staircase value at permanent-on(20%~100%)”

The function defines the output of the staircase lighting as a fixed brightness value. It will not switch off the staircase lighting without receiving the OFF message from “permanent on”. “Permanent on” is another output mode of the staircase lighting. The DOWN time of turning off the lighting is set by the parameter “Time for dimming down to 20% (Duration=Entry*2)”. It will switch off the lighting when going down to 20%. The range value is 20%~100%.

Parameter “On reception switch OBJ=0 switch off enable”

Options:

Enable

Disable

The output can be switched off by object “switch” no matter in switch or permanent on mode with “Enable”; but only off output “Permanent on” by using “permanent on” to send OFF command in the “permanent on” lighting mode with “Disable”.

Note: In the switch output mode, it can start the “permanent on” output mode, but can’t be performed the off operation of “permanent on” when you did not start the “permanent on” output mode.

Table 6.1 Communication objects table “Switch”

6.1.2 Communication objects “Switch /Dimming”

Number	Name	Object Function	Description	Group Addresses	Length	C	R	W	T	U	Data Type	Priority
0	Input A	Switch dimming			1 bit	C	-	W	T	-		Low
1	Input A	Dimming			4 bit	C	-	-	T	-		Low
4	Input A	Disable communication			1 bit	C	-	W	-	-		Low

Fig.6.2 Communication objects “Switch/Dimming”

No.	Function	Object name	Data type	Flags	DPT
1	Input X	Switch	1bit	C,W,T	1.001 DPT_Switch
<p>It is visible if parameter “Dimming functionality” selected “Dimming and switching”. Operate with a short operation to input the object value to carry out the relevant action, such as ON, OFF, TOGGLE.</p> <p>Telegram value 0 OFF 1 ON</p>					
2	Input X	Dimming	4bit	C,T	3.007 DPT_Control Dimming
<p>This communication object inputs by a long operation, and sends the command to dim up or dim down. It can make the dimming device on the bus to carry out relative dimming. It will send a stop command to stop dimming when the long operation is end. (The object inputs with a long operation if the option “dimming and switching” is selected with the parameter “dimming functionality”. There is no distinction between short/long operations if the option is “only dimming”.)</p>					

Table 6.2 Communication objects table “Switch/Dimming”

6.1.3 Communication objects “Value/force output”

There are many data types and communication objects; it will not list in Fig.6.3. The communication objects of different data types have the same operation that are transmit the object value, which the range of transmit object value are different. It is possible to distinguish a long/short operation or not.

Number	Name	Object Function	Description	Group Addresses	Length	C	R	W	T	U	Data Type	Priority
0	input A	1bit-short/close			1 bit	C	-	-	T	-	1 bit DPT_Switch	Low
1	input A	1bit-long/open			1 bit	C	-	-	T	-	1 bit DPT_Switch	Low
4	Input A	Disable communication			1 bit	C	-	W	-	-	1 bit DPT_Enable	Low

Fig. 6.3 Communication objects “Value/Forced output”

No.	Function	Object name	Data type	Flags	DPT
0	Input X	1bit-short/close	1bit [0/1]	C,T	1.001 DPT_Switch
		2bit- short/close	2bit [0...3]		2.002 DPT_Bool_Control
		4bit- short/close	4bit [0...15]		3.007 DPT_Control_Dimming
		1byte signed- short/close	1byte [-128...127]		6.010 DPT_Value_1_Count

		1byte unsigned- short/close 1byte recall scene- short/close 1byte store scene- short/close 2byte signed- short/close 2byte unsigned- short/close 2byte float-short/close 3byte time- short/close 4byte signed- short/close 4byte unsigned- short/close	1byte [0...255] 1byte [recall scene] 1byte [store scene] 2byte [-32768...32767] 2byte [0...65535] 2byte[float] 3byte[time of day] 4byte [-2147483648...2147483647] 4byte [0...4294967295]		5.010 DPT_Value_1_UCount 17.001 DPT_SceneControl 18.001 DPT_SceneControl 8.001 DPT_Value_2_Count 7.001 DPT_Value_2_UCount 9.001 DPT_Value_Temp 10.001 DPT_TimeOfDay 13.001 DPT_Value_4_Count 12.001 DPT_Value_4_UCount
<p>This communication object is used to transmit the input value. It is only transmit the object value in short operation if distinguish a long and short operation. It will transmit the object value when the contact is closed if no distinction between long and short operation. The object value range depend on the data type, The data type is set in the parameter “Reaction on short operation/closing the contact”.</p>					
1	Input X	1bit-long/open 2bit- long/open 4bit- long/open 1byte signed- long/open 1byte unsigned- long/open 1byte recall scene- long/open 1byte store scene- long/open 2byte signed- long/open 2byte unsigned- long/open 2byte float- long/open 3byte time- long/open 4byte signed- long/open 4byte unsigned- long/open	1bit [0/1] 2bit [0...3] 4bit [0...15] 1byte [-128...127] 1byte [0...255] 1byte [recall scene] 1byte [store scene] 2byte [-32768...32767] 2byte [0...65535] 2byte[float] 3byte[time of day] 4byte [-2147483648...2147483647] 4byte [0...4294967295]	C,T	1.001 DPT_Switch 2.002 DPT_Bool_Control 3.007 DPT_Control_Dimming 6.010 DPT_Value_1_Count 5.010 DPT_Value_1_UCount 17.001 DPT_SceneControl 18.001 DPT_SceneControl 8.001 DPT_Value_2_Count 7.001 DPT_Value_2_UCount 9.001 DPT_Value_Temp 10.001 DPT_TimeOfDay 13.001 DPT_Value_4_Count 12.001 DPT_Value_4_UCount
<p>This communication object is used to transmit the input value. It is only transmit the object value in long operation if distinguish a long and short operation. It will transmit the object value when the contact is opened if no distinction between long and short operation. The object value range depend on the data type, The data type is set in the parameter “Reaction on long operation/opening the contact”.</p>					

Table 6.3 Communication objects table “Value/Forced output”

6.1.4 Communication objects “Shutter control”

The communication objects “Shutter Control” will be shown in Fig.6.4.

Number	Name	Object Function	Description	Group Addresses	Length	C	R	W	T	U	Data Type	Priority
0	Input A	shutter UP/DOWN			1 bit	C	-	-	T	-		Low
1	Input A	Stop/lamella adj			1 bit	C	-	-	T	-		Low
2	Input A	Upper limit position			1 bit	C	-	W	-	-		Low
3	Input A	Lower limit position			1 bit	C	-	W	-	-		Low
4	Input A	Disable communication			1 bit	C	-	W	-	-		Low

Fig. 6.4 Communication objects “Shutter Control”

No.	Function	Object name	Data type	Flags	DPT
0	Input X	shutter UP/DOWN	1Bit	C,T	1.008 DPT_UpDown
This communication object sends a shutter move command (up or down) to the bus. Telegram value 0 move up 1 move down					
1	Input X	Stop/lamella adj	1Bit	C,T	1.007 DPT_Step
This communication object sends a stop command or lamella adjustment. Telegram value 0 stop/adjust up 1 stop/adjust down					
2	Input X	Upper limit position	1Bit	C,W	1.002 DPT_Bool
The object is used to upper limit shutter moving. Telegram value 0 no limit moving up 1 limit moving up					
3	Input X	Lower limit position	1Bit	C,W	1.002 DPT_Bool
The object is used to lower limit shutter moving. Telegram value 0 no limit moving down 1 limit moving down					

Table 6.4 Communication objects table “Shutter Control”

6.2 Communication objects of Switch outputs (A~L)

Take an output as the example to describe the function of each communication object in the following.

Number	Name	Object Function	Description	Group Addresses	Length	C	R	W	T	U
112	Output A	Switch, A			1 bit	C	-	W	-	-
113	Output A	reply switch status, A			1 bit	C	R	-	T	-
114	Output A	Disable time function, A			1 bit	C	-	W	-	-
115	Output A	Scene, A			1 Byte	C	-	W	-	-
116	Output A	Forced output, A			1 bit	C	-	W	-	-
117	Output A	Input 1 of logic, A			1 bit	C	-	W	-	-
118	Output A	Input 2 of logic, A			1 bit	C	-	W	-	-

Fig. 6.5 Communication objects of switch actuator

No.	Function	Object name	Data type	Flags	DPT
112	Output X	Switch, X	1bit	C,W	1.001 DPT_Switch
This object is used to trigger the switch operation. It will start the switch operation with “1”, and end with “0”. When					

enabling "input 0" in the logic function or time function, the object "Switch, X" will be subject to logic functions and time function, rather than trigger the switch operation directly. For details, please refer to the following flowchart:

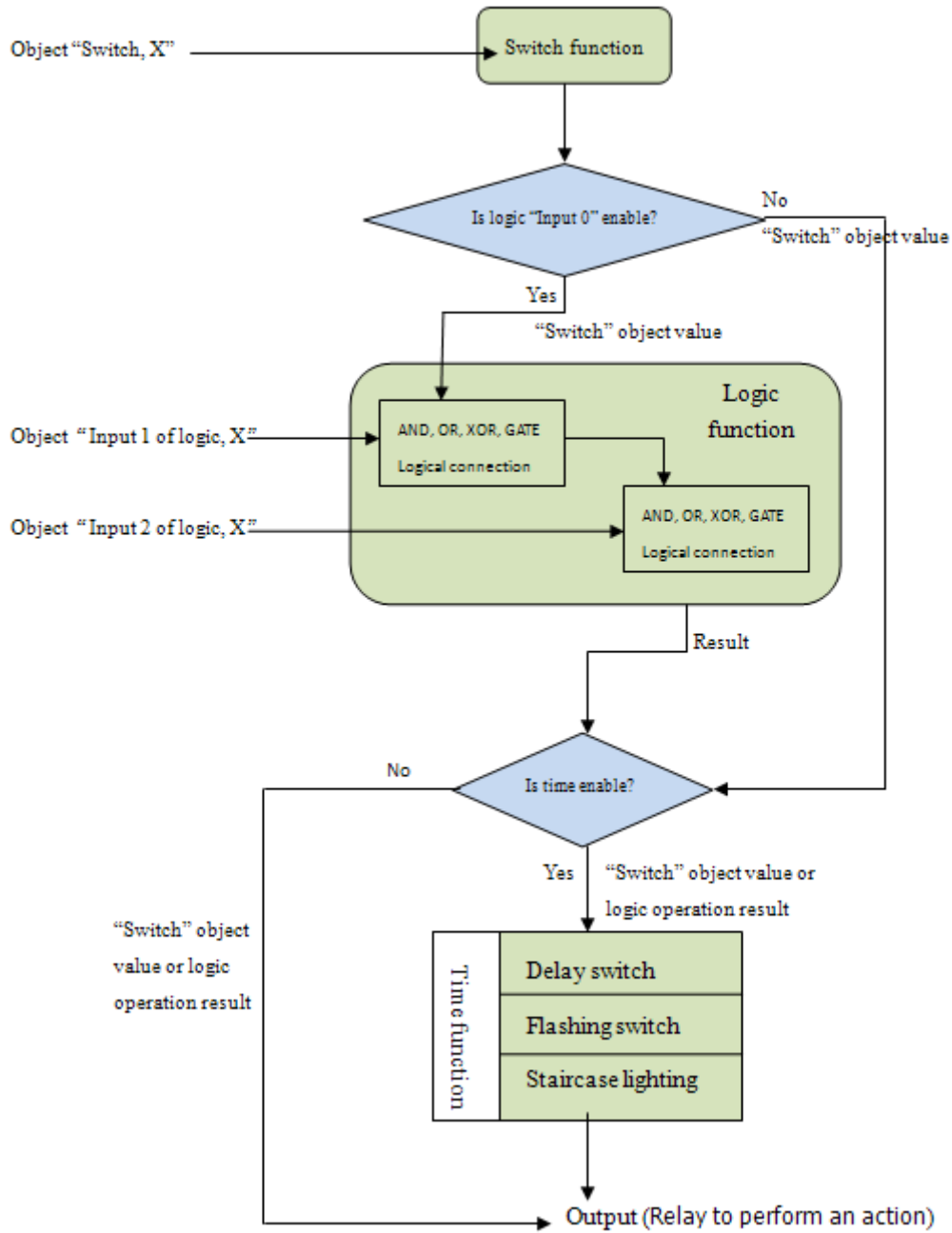

113	Output X	Reply switch status, X	1bit	C,R,T	1.001 DPT_Switch
-----	----------	------------------------	------	-------	------------------

This object will be enabled when selecting "respond after change" or "respond, after read only" in the parameter "Response mode of switch status for output X", which will indicate the contact status (details will be defined by parameter "Object value of switch status:" in "Channel X: Switch").

If selecting "respond, after read only", the status telegram will not be sent out until receiving a read request telegrams

from the bus via the object.

If selecting “respond after change”, it will send the status automatically via the object when there are any changes on the output.

114	Output X	Disable time function, X	1bit	C,W	1.003 DPT_Enable
-----	----------	--------------------------	------	-----	------------------

This object will be enabled only when enabling the time function, it can be used to enable and disable the time function. It will enable the timing function when receiving the value “1”; will disable it when receiving “0”. The operation before disabled it is still carried out completely. Enable is a default setting after bus voltage recovery if the time function is set.

115	Output X	Scene, X	1byte	C,W	18.001 DPT_SceneControl
-----	----------	----------	-------	-----	-------------------------

It is able to recall or save the scene when sending an 8-bit command by this object, which will be enabled when enabling the scene function. The definition of the 8-bit command will be described below:

Assuming an 8-bit command (binary coding) as: FXNNNNNN

F: recall the scene with “0”; save the scene with “1”;

X: 0

NNNNNN: scene number (0-63).

1-64 in the parameter setup corresponds to the scene number 0-63 received by the communication object “Scene”. For example, scene 1 in the parameter setup has the same output result as scene 0 in the communication object “Scene”. As follow:

Object value	Description
0	Recall scene 1
1	Recall scene 2
2	Recall scene 3
...	...
63	Recall scene 64
128	Store scene 1
129	Store scene 2
130	Store scene 3
...	...
191	Store scene 64

116	Output X	Forced output, X	1bit/2bit	C,W	1.003 DPT_Enable /2.001 DPT_Switch
-----	----------	------------------	-----------	-----	------------------------------------

This object will be enabled after enabling the forced function.

If 1bit, Enable the forced operation with “1”, and the other behaviors will be ignored except the forced function; cancel the forced operation with “0”. The contact position of force operation can be set via a parameter.

If 2bit, the contact is forced closed when receiving telegram “3”; the contact is forced opened when receiving telegram “2”; cancel the force operation with telegram “1” or “0”.					
117	Output X	Input 1 of logic, X	1bit	C,W	1.001 DPT_Switch
This object will be enabled when selecting “enable” in the parameter “The input 1 of logic is”, which is used to modify logic value of input 1.					
118	Output X	Input 2 of logic, X	1bit	C,W	1.001 DPT_Switch
This object will be enabled when selecting “enable” in the parameter “The input 2 of logic is”, which is used to modify logic value of input 2.					

Table 6.5 Communication objects table of switch actuator

6.3 Communication objects of Shutter outputs (M~N)

196	Output M	Shutter position[0...100%]	1 Byte	C R W T -	Low
197	Output M	Louvre position[0...100%]	1 Byte	C R W T -	Low
198	Output M	Shutter UP/DOWN	1 bit	C - W - -	Low
199	Output M	Louvre adj./Stop	1 bit	C - W - -	Low
200	Output M	Reference movement	1 bit	C - W - -	Low
201	Output M	Status byte	1 Byte	C R - T -	Low
203	Output M	Sun operation	1 bit	C - W - -	Low
204	Output M	Dis auto. control	1 bit	C - W - -	Low
205	Output M	Sun:shutter position[0...100%]	1 Byte	C - W - -	Low
206	Output M	Sun:Louvre adj.[0...100%]	1 Byte	C - W - -	Low
207	Output M	Scene	1 Byte	C - W - -	Low
208	Shutter/Blinds	Safety operation 1	1 bit	C - W - -	Low
209	Shutter/Blinds	Safety operation 2	1 bit	C - W - -	Low
210	Output N	Shutter position[0...100%]	1 Byte	C R W T -	Low
211	Output N	Louvre position[0...100%]	1 Byte	C R W T -	Low
212	Output N	Shutter UP/DOWN	1 bit	C - W - -	Low
213	Output N	Louvre adj./Stop	1 bit	C - W - -	Low
214	Output N	Reference movement	1 bit	C - W - -	Low
215	Output N	Status byte	1 Byte	C - - T -	Low
217	Output N	Sun operation	1 bit	C - W - -	Low
218	Output N	Dis auto. control	1 bit	C - W - -	Low
219	Output N	Sun:shutter position[0...100%]	1 Byte	C - W - -	Low
220	Output N	Sun:Louvre adj.[0...100%]	1 Byte	C - W - -	Low
221	Output N	Scene	1 Byte	C - W - -	Low
201	Output M	End position(Upper)	1 bit	C R - T -	Low
202	Output M	End position(Lower)	1 bit	C R - T -	Low
215	Output N	End position(Upper)	1 bit	C R - T -	Low
216	Output N	End position(Lower)	1 bit	C R - T -	Low

Fig. 6.6 Communication objects of shutter actuator

No.	Function	Object name	Data type	Flags	DPT
196	Output X	Shutter/Blinds position[0...100%]	1byte	C,R,W,T	5.001 DPT_Scaling
<p>If this communication object receives a telegram value, the Shutter/Blind moves to the corresponding position for the received value. In the “Shutter” operation mode, after the Shutter reaching the target position, the louvres are positioned as before. Only the object “Louvre position [0...100%]” receives a telegram value, the louvres will be positioned accordingly.</p> <p>Telegram value 0% ——— top ——— intermediate position 100% ——— bottom</p>					
197	Output X	Louvre position[0...100%]	1byte	C,R,W,T	5.001 DPT_Scaling

<p>Only in the “Shutter” operation mode, the communication is visible. If the object receives a telegram value, the louvres are positioned according to the received value.</p> <p>Telegram value 0% —— louvres opened to maximum —— intermediate position 100% —— louvres closed to maximum</p>																							
198	Output X	Shutter/Blinds UP/DOWN	1Bit	C,W	1.008 DPT_UpDown																		
<p>If this communication object receives a telegram with the value “0”, the Shutter/Blind is raised. If the object receives a telegram with the value “1”, the Shutter/Blind is lowered. The output contact reverts to the neutral position once the total move time for UP/DOWN movement has elapsed.</p> <p>Telegram value 0 —— UP 1 —— DOWN</p>																							
199	Output X	Louvre adj. / Stop	1Bit	C,W	1.007 DPT_Step																		
<p>If the Shutter/Blind is in motion, the movement is stopped on this communication object receiving a telegram value “0” or “1”.</p> <p>“Shutter” operating mode: if the Blind is idle, it is raised for the louvres adjustment on the communication object receiving a telegram value “0”; it is lowered for the louvres adjustment on the communication object receiving a telegram value “1”.</p> <p>“Blind” operating mode: if the Shutter is idle, no action is carried out on the communication object receiving any telegram value.</p> <p>Telegram value 0 ——stop/louvre adj. UP 1 —— stop/louvre adj. DOWN</p> <p>After the louvers have been reached to limit position, the telegram will be ignored if continually adjust in the same direction.</p>																							
200	Output X	Reference movement	1Bit	C,W	1.008 DPT_UpDown																		
<p>The communication object is enabled when the “disable” option is not selected in the parameter “position after reference movement”. If the object receives a telegram value, the Shutter/Blind is carried out a reference movement that makes sure its location exactly.</p> <p>Telegram value 0——first the Shutter/Blind is fully raised, then move to the target position 1—— first the Shutter/Blind is fully lowered, then move to the target position</p> <p>The detail process is described in relevant parameter chapter.</p>																							
201	Output X	Status byte	1byte	C,R,T	No DPT																		
<p>The communication object is enabled when the option “Status byte” is selected in the parameter “status response of position via ‘End position/Status byte’ objects” and the parameter “Response mode for position” is not “none”, which is used to send the current operation status after a change or a request. The information is provided in coded format in a 1byte value, see table below:</p> <table border="1"> <thead> <tr> <th>Data bits</th> <th>Bit7</th> <th>Bit6</th> <th>Bit5</th> <th>Bit4</th> <th>Bit3</th> <th>Bit2</th> <th>Bit1</th> <th>Bit0</th> </tr> </thead> <tbody> <tr> <td>Functions</td> <td>Not used</td> <td>Not used</td> <td>Safety 2</td> <td>Safety 1</td> <td>Automatic</td> <td>Sun</td> <td>Upper end position</td> <td>Lower end position</td> </tr> </tbody> </table>						Data bits	Bit7	Bit6	Bit5	Bit4	Bit3	Bit2	Bit1	Bit0	Functions	Not used	Not used	Safety 2	Safety 1	Automatic	Sun	Upper end position	Lower end position
Data bits	Bit7	Bit6	Bit5	Bit4	Bit3	Bit2	Bit1	Bit0															
Functions	Not used	Not used	Safety 2	Safety 1	Automatic	Sun	Upper end position	Lower end position															

Values	0	0	0:inactive 1:active	0:inactive 1:active	0:inactive 1:active	0:inactive 1:active	0:inactive 1:active	0:inactive 1:active
<p>Note:</p> <p>① Special coding for Bit1 and Bit0:</p> <p>00—Shutter between upper and lower end position</p> <p>01—lower end position</p> <p>10—upper end position</p> <p>11—Shutter position undefined</p> <p>② The sun belongs to the auto. Operation, so it only can be activated when auto. Operation is enabled.</p> <p>③ The upper end position only indicates the position of shutter/blind is 0%, rather than the louvre also is 0%. So does the lower end position.</p> <p>④ The safety operations have the most priority, and the safety operation 2 is higher than 1.</p>								
201	Output X	End position (Upper)	1Bit	C,R,T	1.002 DPT_Bool			
<p>The communication object is enabled when the option “End position” is selected in the parameter “status response of position via ‘End position/Status byte’ objects” and the parameter “Response mode for position” is not “none”, which is used to send the Upper end position status after a change or a request. When the shutter/blind reach the upper end position, the object sends a telegram “1” immediately, leave the position, and send “0”.</p> <p>The upper end position only indicates the position of shutter/blind is 0%, rather than the louvre also is 0%.</p> <p>Telegram value 0—the shutter/blind is not in the upper end position</p> <p> 1—the shutter/blind is in the upper end position</p>								
202	Output X	End position (Lower)	1Bit	C,W	1.002 DPT_Bool			
<p>The communication object is enabled when the option “End position” is selected in the parameter “status response of position via ‘End position/Status byte’ objects” and the parameter “Response mode for position” is not “none”, which is used to send the lower end position status after a change or a request. When the shutter/blind reach the lower end position, the object sends a telegram “1” immediately, leave the position, and send “0”.</p> <p>The lower end position only indicates the position of shutter/blind is 100%, rather than the louvre also is 100%.</p> <p>Telegram value 0—the shutter/blind is not in the lower end position</p> <p> 1—the shutter/blind is in the lower end position</p>								
203	Output X	Sun operation	1bit	C,W	1.001 DPT_Switch			
<p>If the communication object receives a telegram “0” or “1”, the shutter/blind is moved into a predefined position, see the parameter chapter description.</p>								

GVS K-BUS® KNX/EIB Room Controller

204	Output X	Dis. Auto. control	1bit	C,W	1.003 DPT_Enable								
<p>The communication object is used to disable and enable the Auto. Operation. If the object receives a telegram “0”, the Auto. Operation is deactivated; if the object receives a telegram “1”, the Auto. Operation is activated.</p> <p>Telegram value 0——deactivate the Auto. Operation 1—— activate the Auto. Operation</p>													
205	Output X	Sun: shutter/blinds position[0...100%]	1byte	C,W	5.001 DPT_Scaling								
<p>In Auto. Operation status, if this communication object receives a telegram value, the Shutter/Blind moves to the corresponding position for the received value. In the “Shutter” operation mode, after the Shutter reaching the target position, the louvres are positioned as before. Only the object “Sun: louvre adj. [0...100%]” receives a telegram value, the louvres will be positioned accordingly.</p> <p>Telegram value 0 —— top —— intermediate position 100%—— bottom</p>													
206	Output X	Sun: louvre adj.[0...100%]	1byte	C,W	5.001 DPT_Scaling								
<p>In Auto. Operation status, the communication is visible only in the “Shutter” operation mode. If the object receives a telegram value, the louvres are positioned according to the received value.</p> <p>Telegram value 0 —— louvres opened to maximum —— intermediate position 100%—— louvres closed to maximum</p>													
207	Output X	Scene	1byte	C,W	18.001 DPT_SceneControl								
<p>It is able to recall or store the scene when sending an 8-bit command by this object. The definition of the 8-bit command will be described below:</p> <p>Assuming an 8-bit command (binary coding) as: FXNNNNNN</p> <p style="padding-left: 100px;">F: recall scene with “0”; store scene with “1”; X: 0 NNNNNN: scene number (0-63).</p> <p>1-64 in the parameter setting corresponds to the scene number 0-63 received by the communication object “Scene”. For example, scene 1 in the parameter setting has the same output result as scene 0 in the communication object “Scene”.</p> <p>As follow:</p> <table border="1" style="margin-left: auto; margin-right: auto;"> <thead> <tr> <th>Object value</th> <th>Description</th> </tr> </thead> <tbody> <tr> <td style="text-align: center;">0</td> <td>Recall scene 1</td> </tr> <tr> <td style="text-align: center;">1</td> <td>Recall scene 2</td> </tr> <tr> <td style="text-align: center;">2</td> <td>Recall scene 3</td> </tr> </tbody> </table>						Object value	Description	0	Recall scene 1	1	Recall scene 2	2	Recall scene 3
Object value	Description												
0	Recall scene 1												
1	Recall scene 2												
2	Recall scene 3												

			
		63	Recall scene 64		
		128	Store scene 1		
		129	Store scene 2		
		130	Store scene 3		
			
		191	Store scene 64		
208	Output X	Safety operation 1	1bit	C,W	1.005 DPT_Alarm
<p>The communication object is visible if the safety operation 1 is enabled in the parameter window “General”, which is used to receive a special 1bit telegram from some sensors sending cyclically. Such as the special telegram is “1” via parameter, if the object doesn’t receive the telegram “1” from the sensor during the monitor period, the actuator will think that the sensor malfunctions, and then triggered the safety operation 1 and make the shutter move to a safety position. When the actuator receives a telegram “1” again, the monitor period will re-timing, and exit the safety operation, other operations can be carried out.</p> <p>The priority of “Safety operation 1” is higher than other operations, only lower than “Safety operation 2”</p>					
209	Output X	Safety operation 2	1bit	C,W	1.005 DPT_Alarm
See communication object 208.					

Table 6.6 Communication objects table of Shutter actuator

6.4 Communication objects of fan control (O~Q)

6.4.1 Communication objects of “O, P, Q as fan speed control”

The output O,P,Q as fan speed control, the communication objects as follows:

6.4.1.1 Communication objects of “Fan-one level”

When the fan type is one level, the communication objects as follows:

Number	Name	Object Function	Description	Group Addresses	Length	C	R	W	T	U	Data Type	Priority
223	1Level-Fan	Fan Switch			1 bit	C	-	W	-	-		Low
227	1Level-Fan	Fan status ON/OFF			1 bit	C	R	-	T	-		Low
232	1Level-Fan	Fan Limitation 1			1 bit	C	-	W	-	-		Low
233	1Level-Fan	Fan Limitation 2			1 bit	C	-	W	-	-		Low
234	1Level-Fan	Fan Limitation 3			1 bit	C	-	W	-	-		Low
235	1Level-Fan	Fan Limitation 4			1 bit	C	-	W	-	-		Low
236	1Level-Fan	Fan Forced Operation			1 bit	C	-	W	-	-		Low
237	1Level-Fan	Fan Automatic ON/OFF			1 bit	C	-	W	-	-		Low
238	1Level-Fan	Fan status automatic			1 bit	C	R	-	T	-		Low
239	1Level-Fan	Fan status byte mode			1 Byte	C	R	-	T	-		Low

Fig. 6.7 Communication objects “Fan-one level”

No.	Function	Object name	Data type	Flags	DPT
223	1Level-Fan	Fan switch	1bit	C,W	1.001 DPT_Switch
<p>With this 1 bit communication object the fan can be switched on or off.</p> <p>If several ON/OFF telegrams are received, the value last received for the fan control is decisive.</p> <p>Telegram value 0 — fan OFF 1 — fan ON</p>					
227	1Level-Fan	Fan status ON/OFF	1bit	C,R,T	1.001 DPT_Switch
<p>This communication object is enabled if in parameter window “Fan: Status” the parameter “Enable Obj. ‘status ON/OFF mode’” have been selected with option “yes”. The value of the communication object is updated and sent when the switch status of the fan is changed, or sent on request.</p> <p>Telegram value 0 — fan OFF 1 — fan ON</p>					
232	1Level-Fan	Fan Limitation 1	1bit	C,W	1.003 DPT_Enable
<p>This communication object is enabled if in parameter window “Fan: auto. Operation” the parameter “Limitation function is” has been selected with the option “yes”.</p> <p>The limitation 1 is active if a telegram “1” is received on the object. The limitation 1 is deactivated if a telegram “0” is received on the object.</p> <p>When the limitation 1 is activated, the fan can only assume the set fan status in the parameter “Fan with limitation 1”.</p> <p>Telegram value 0 — limitation 1 inactive 1 — limitation 1 active</p> <p>Note: limitation 1 is only active in automatic mode.</p>					
233	1Level-Fan	Fan Limitation 2	1bit	C,W	1.003 DPT_Enable
<p>See communication object 232</p>					
234	1Level-Fan	Fan Limitation 3	1bit	C,W	1.003 DPT_Enable
<p>See communication object 232</p>					
235	1Level-Fan	Fan Limitation 4	1bit	C,W	1.003 DPT_Enable
<p>See communication object 232</p>					
236	1Level-Fan	Fan Forced Operation	1bit	C,W	1.003 DPT_Enable
<p>The communication object is enabled if in parameter window “Fan speeds” the parameter “Enable 1bit ‘Forced operation’ Obj.” has been selected with the option “yes”.</p> <p>The forced operation can be activated via the object receiving a telegram “0” or “1” set by the parameter “forced operation on object value is”. When the object receives an inverse telegram value, the forced operation is cancelled.</p> <p>The switch status of the fan can be parameterized during forced operation.</p>					

<p>If the parameter “forced operation on object value is” is set to “1”:</p> <p>Telegram value 0 ——no forced operation 1 —— forced operation</p> <p>If the parameter “forced operation on object value is” is set to “0”:</p> <p>Telegram value 0 —— forced operation 1 ——no forced operation</p>																							
237	1Level-Fan	Fan Automatic ON/OFF	1bit	C,W	1.003 DPT_Enable																		
<p>The communication object is enabled if in parameter window “Fan speeds” the parameter “Auto. Operation is” has been selected with the option “yes”.</p> <p>The Auto. Operation can be activated via the object receiving a telegram “0” or “1” set by the parameter “carry out auto. Operation when the object value is”. When the object receives an inverse telegram value, the Auto. Operation is disabled.</p> <p>After bus voltage recovery or programming, the Auto. Operation is inactive by default.</p> <p>During the Auto. Operation, if the direct operation or the forced operation is activated, the Auto. Operation will be disabled automatically. But these limit status is still retained, and is valid again if the Auto.operation is activated again.</p> <p>If the parameter “carry out auto. Operation when the object value is” is set to “1”:</p> <p>Telegram value 0 ——the Auto. operation inactive 1 —— the Auto. operation active</p> <p>If the parameter “carry out auto. Operation when the object value is” is set to “0”:</p> <p>Telegram value 0 ——the Auto. operation active 1 —— the Auto. operation inactive</p>																							
238	1Level-Fan	Fan status automatic	1bit	C,R,T	1.003 DPT_Enable																		
<p>This communication object is enabled if in parameter window “Fan: Status” the parameter “Enable Obj. ‘status Auto. Mode” has been selected with option “yes”. The value of the communication object is updated and sent when the status of the Auto. Operation is changed, or sent on request.</p> <p>Telegram value 0 ——the Auto. operation inactive 1 —— the Auto. operation active</p>																							
239	1Level-Fan	Fan status byte mode	1byte	C,R,T	No DPT																		
<p>This communication object is enabled if in parameter window “Fan: Status” the parameter “Enable Obj. ‘status byte mode” has been selected with option “yes”. The value of the communication object is updated and sent when the operation status of the fan is changed, or sent on request. The information is provided in coded format in a 1byte value, see table below:</p> <table border="1" style="margin-left: auto; margin-right: auto;"> <tr> <td colspan="9" style="text-align: center;">object “Fan status byte mode”</td> </tr> <tr> <td>Data bits</td> <td>Bit7</td> <td>Bit6</td> <td>Bit5</td> <td>Bit4</td> <td>Bit3</td> <td>Bit2</td> <td>Bit1</td> <td>Bit0</td> </tr> </table>						object “Fan status byte mode”									Data bits	Bit7	Bit6	Bit5	Bit4	Bit3	Bit2	Bit1	Bit0
object “Fan status byte mode”																							
Data bits	Bit7	Bit6	Bit5	Bit4	Bit3	Bit2	Bit1	Bit0															

funcations	Forced operation	Limit 1	Limit 2	Limit 3	Limit 4	Thermostat fault	Auto. operation	Heating/ Cooling
values	0:inactive 1:active	0:inactive 1:active	0:inactive 1:active	0:inactive 1:active	0:inactive 1:active	0:inactive 1:active	0:inactive 1:active	0:Cooling 1:Heating
NOTE: bit0 和 bit2 currently not use.								

Table 6.7 Communication objects table “Fan-one level”

6.4.1.2 Communication objects of“Fan-multi level”

When the fan type is multi level, the communication objects as follows:

Number	Name	Object Function	Description	Group Addresses	Length	C	R	W	T	U	Data Type	Priority
222	Multi-Fan	Fan speed switch			1 Byte	C	-	W	-	-		Low
223	Multi-Fan	Fan speed 1			1 bit	C	-	W	-	-		Low
224	Multi-Fan	Fan speed 2			1 bit	C	-	W	-	-		Low
225	Multi-Fan	Fan speed 3			1 bit	C	-	W	-	-		Low
226	Multi-Fan	Fan speed UP/DOWN			1 bit	C	-	W	-	-		Low
227	Multi-Fan	Fan status ON/OFF			1 bit	C	R	-	T	-		Low
228	Multi-Fan	Fan status speed			1 Byte	C	R	-	T	-		Low
229	Multi-Fan	Fan status speed 1			1 bit	C	R	-	T	-		Low
230	Multi-Fan	Fan status speed 2			1 bit	C	R	-	T	-		Low
231	Multi-Fan	Fan status speed 3			1 bit	C	R	-	T	-		Low
232	Multi-Fan	Fan Limitation 1			1 bit	C	-	W	-	-		Low
233	Multi-Fan	Fan Limitation 2			1 bit	C	-	W	-	-		Low
234	Multi-Fan	Fan Limitation 3			1 bit	C	-	W	-	-		Low
235	Multi-Fan	Fan Limitation 4			1 bit	C	-	W	-	-		Low
236	Multi-Fan	Fan Forced Operation			1 bit	C	-	W	-	-		Low
237	Multi-Fan	Fan Automatic ON/OFF			1 bit	C	-	W	-	-		Low
238	Multi-Fan	Fan status automatic			1 bit	C	R	-	T	-		Low
239	Multi-Fan	Fan status byte mode			1 Byte	C	R	-	T	-		Low

Fig. 6.8 communication objects “Fan-multi level”

No.	Function	Object name	Data type	Flags	DPT
222	Multi-Fan	Fan speed witch	1byte	C,W	5.010 DPT_Value_1_UCount
<p>The communication object is enabled if in parameter window “Fan speeds” the parameters “enable direct operation” and “Enable ‘Fan speed switch’ obj.” have been selected with the option “yes”.</p> <p>With this communication object the fan can be switched on via a 1byte communication object of a fan speed. If another fan speed is switched on, at this point it will be switched off. A new fan speed is switched on taking the start-up phase into consideration.</p> <p>Telegram value:</p> <p><threshold value 1 —— the fan off</p> <p>>=threshold value 1 —— fan speed 1</p> <p>>=threshold value 2 —— fan speed</p> <p>>=threshold value 3 —— fan speed 3</p>					

223	Multi-Fan	Fan speed 1	1bit	C,W	1.001 DPT_Switch
<p>The communication object is enabled if in parameter window “Fan speeds” the parameters “enable direct operation” and “Enable ‘Fan speed switch’ obj.” have been selected with the option “yes”.</p> <p>Via the communication object, the fan speed 1 can be switched on.</p> <p>If several On telegrams are received consecutively in a short period of time at various fan speed 1-3 communication objects, the value last received by the fan control is the decisive value.</p> <p>An OFF telegram to one of the three communication objects, fan speed 1-3, switches off the fan completely.</p> <p>Telegram value:</p> <p style="padding-left: 40px;">0 — fan OFF</p> <p style="padding-left: 40px;">1 — fan ON in speed 1</p>					
224	Multi-Fan	Fan speed 2	1bit	C,W	1.001 DPT_Switch
<p>See communication object 223</p>					
225	Multi-Fan	Fan speed 3	1bit	C,W	1.001 DPT_Switch
<p>See communication object 223</p>					
226	Multi-Fan	Fan speed UP/DOWN	1bit	C,W	1.007 DPT_Step
<p>The communication object is enabled if in parameter window “Fan speeds” the parameters “enable direct operation” and “Enable ‘Fan speed Up/Down’ obj.” have been selected with the option “yes”.</p> <p>With this communication object, the fan can be switched one fan speed further up or down. Switching (UP/DOWN) is determined by the telegram value. After the maximum or minimum speed is achieved, further UP/DOWN telegrams are ignored and not executed.</p> <p>Telegram value:</p> <p style="padding-left: 40px;">0 — switch fan speed DOWN</p> <p style="padding-left: 40px;">1 — switch fan speed UP</p>					
227	Multi-Fan	Fan status ON/OFF	1bit	C,R,T	1.001 DPT_Switch
<p>This communication object is enabled if in parameter window “Fan: Status” the parameter “Enable Obj. ‘status ON/OFF mode’” have been selected with option “yes”. The value of the communication object is updated and sent when the switch status of the fan is changed, or sent on request.</p> <p>Telegram value</p> <p style="padding-left: 40px;">0 — fan OFF</p> <p style="padding-left: 40px;">1 — fan ON, at least one fan speed is not off.</p> <p><i>Note: some fans require an ON telegram before you set a fan speed. Using the communication object Fan status ON/OFF, the fan can, for example, be switched on centrally with a switch actuator via the main switch.</i></p>					
228	Multi-Fan	Fan status speed	1byte	C,R,T	5.010 DPT_Value_1_UCount
<p>This communication object is enabled if in parameter window “Fan: Status” the parameter “Enable Obj. ‘status fan</p>					

<p>speed' ” have been selected with option “yes”. The value of the communication object is updated and sent when the status of the fan speed is changed, or sent on request.</p> <p>Telegram value:</p> <p>0 — the fan off</p> <p>1 — fan speed 1</p> <p>2 — fan speed 2</p> <p>3 — fan speed 3</p>					
229	Multi-Fan	Fan status speed 1	1bit	C,R,T	1.001 DPT_Switch
<p>This communication object is enabled if in parameter window “Fan: Status” the parameter “Enable Obj. ‘status fan speed x’ ” have been selected with option “yes”. The value of the communication object is updated and sent when the switch status of the fan speed is changed, or sent on request.</p> <p>Telegram value 0 — fan speed 1OFF</p> <p> 1 — fan speed 1 ON</p>					
230	Multi-Fan	Fan status speed 2	1bit	C,R,T	1.001 DPT_Switch
See communication object 229					
231	Multi-Fan	Fan status speed 3	1bit	C,R,T	1.001 DPT_Switch
See communication object 229					
232	Multi-Fan	Fan Limitation 1	1bit	C,W	1.003 DPT_Enable
<p>This communication object is enabled if in parameter window “Fan: auto. Operation” the parameter “Limitation function is” has been selected with the option “yes”.</p> <p>The limitation 1 is active if a telegram “1” is received on the object. The limitation 1 is deactivated if a telegram “0” is received on the object.</p> <p>When the limitation 1 is activated, the fan can only assume the fan speed or fan speed ranges as parameterised in fan speed with limitation 1.</p> <p>Telegram value 0 — limitation 1 inactive</p> <p> 1 — limitation 1 active</p> <p>Note: limitation 1 is only active in automatic mode.</p>					
233	Multi-Fan	Fan Limitation 2	1bit	C,W	1.003 DPT_Enable
See communication object 232					
234	Multi-Fan	Fan Limitation 3	1bit	C,W	1.003 DPT_Enable
See communication object 232					
235	Multi-Fan	Fan Limitation 4	1bit	C,W	1.003 DPT_Enable
See communication object 232					

236	Multi-Fan	Fan Forced Operation	1bit	C,W	1.003 DPT_Enable
<p>The communication object is enabled if in parameter window “Fan speeds” the parameter “Enable 1bit ‘Forced operation’ Obj.” has been selected with the option “yes”.</p> <p>The forced operation can be activated via the object receiving a telegram “0” or “1” set by the parameter “forced operation on object value is”. When the object receives an inverse telegram value, the forced operation is cancelled.</p> <p>When the force operation is activated, the fan can only assume the fan speed or fan speed ranges as parameterised in Limitation on forced operation.</p> <p>During Forced operation, the limits setting in Automatic operation are ignored</p> <p>If the parameter “forced operation on object value is” is set to “1”:</p> <p>Telegram value 0 ——no forced operation 1 —— forced operation</p> <p>If the parameter “forced operation on object value is” is set to “0”:</p> <p>Telegram value 0 —— forced operation 1 ——no forced operation</p>					
237	Multi-Fan	Fan Automatic ON/OFF	1bit	C,W	1.003 DPT_Enable
<p>The communication object is enabled if in parameter window “Fan speeds” the parameter “Auto. Operation is” has been selected with the option “yes”.</p> <p>The Auto. Operation can be activated via the object receiving a telegram “0” or “1” set by the parameter “carry out auto. Operation when the object value is”. When the object receives an inverse telegram value, the Auto. Operation is disabled.</p> <p>After bus voltage recovery or programming, the Auto. Operation is inactive by default.</p> <p>During the Auto. Operaion, if the direct operation is activated, the Auto. Operaion will be disabled automatically. But these limit status is still retained, and is valid again if the Auto.operation is activated again.</p> <p>The direct operaion:</p> <p style="padding-left: 40px;">Fan: Fan speed witch Fan: Fan speed x (x=1,2,3) Fan: Fan speed UP/DOWN</p> <p>During forced operation the automatic mode remains active; however, it is only operated within the allowed limits.</p> <p>If the parameter “carry out auto. Operation when the object value is” is set to “1”:</p> <p>Telegram value 0 ——the Auto. operation inactive 1 —— the Auto. operation active</p> <p>If the parameter “carry out auto. Operation when the object value is” is set to “0”:</p> <p>Telegram value 0 ——the Auto. operation active 1 —— the Auto. operation inactive</p>					

238	Multi-Fan	Fan status automatic	1bit	C,R,T	1.003 DPT_Enable			
<p>This communication object is enabled if in parameter window “Fan: Status” the parameter “Enable Obj. ‘status Auto. Mode” has been selected with option “yes”. The value of the communication object is updated and sent when the status of the Auto. Operation is changed, or sent on request.</p> <p>Telegram value 0 ——the Auto. operation inactive 1 —— the Auto. operation active</p>								
239	Multi-Fan	Fan status byte mode	1byte	C,R,T	No DPT			
<p>This communication object is enabled if in parameter window “Fan: Status” the parameter “Enable Obj. ‘status byte mode” has been selected with option “yes”. The value of the communication object is updated and sent when the operation status of the fan is changed, or sent on request. The information is provided in coded format in a 1byte value, see table below:</p>								
object “Fan status byte mode”								
Data bits	Bit7	Bit6	Bit5	Bit4	Bit3	Bit2	Bit1	Bit0
funcations	Forced operation	Limit 1	Limit 2	Limit 3	Limit 4		Auto. operation	
values	0:inactive 1:active	0:inactive 1:active	0:inactive 1:active	0:inactive 1:active	0:inactive 1:active	0:inactive 1:active	0:inactive 1:active	
NOTE:bit0 和 bit2 currently not use.								

Table 6.8 Communication objects table “Fan-multi level”

6.4.2 Communication object of “O, P, Q as switch control”

The O, P, Q as three channels switching output, the communication objects as shown in fig. 6.9. There is slightly different with the communication objects of the front switch actuator. Here the time functions have own objects, and the logic function has been removed, so their control processs are different.

Number	Name	Object Function	Description	Group Addresses	Length	C	R	W	T	U	Data Type	Priority
222	Output 0	Switch, 0			1 bit	C	-	W	-	-		Low
223	Output 0	reply switch status, 0			1 bit	C	R	-	T	-		Low
224	Output 0	Enable time function, 0			1 bit	C	-	W	-	-		Low
225	Output 0	Scene , 0			1 Byte	C	-	W	-	-		Low
226	Output 0	Forced output , 0			1 bit	C	-	W	-	-		Low
227	Output 0	Switch with delay			1 bit	C	-	W	-	-		Low
226	Output 0	Forced output , 0			2 bit	C	-	W	-	-		Low
227	Output 0	Switch with flashing			1 bit	C	-	W	-	-		Low
227	Output 0	Switch with staircase lighting			1 bit	C	-	W	-	-		Low

Fig. 6.9 Communication objects “O, P, Q” as relay control”

No.	Function	Object name	Data type	Flags	DPT
222	Output X	Switch, X	1bit	C,W	1.001 DPT_Switch
This object is used to receive the switch command to switch the output. It will switch on the output with “1” and off					

with “0”, or on with “0” and off with “1”, set via the parameter “Contact position if tele. Value is “1””																							
223	Output X	Reply switch status, X	1bit	C,R,T	1.001 DPT_Switch																		
<p>This object will be enabled when selecting “respond after change” or “respond, after read only” in the parameter “Response mode of switch status for output X”, which will indicate the contact status (details will be defined by parameter “Object value of switch status:” in “Channel X: Switch”).</p> <p>If selecting “respond, after read only”, the status telegram will not be sent out until receiving a read request telegrams from the bus via the object.</p> <p>If selecting “respond after change”, it will send the status automatically via the object when there are any changes on the output.</p>																							
224	Output X	Disable time function, X	1bit	C,W	1.003 DPT_Enable																		
<p>This object will be enabled only when enabling the time function, it can be used to enable and disable the time function. It will enable the timing function when receiving the value “1”; will disable it when receiving “0”. The operation before disabled it is still carried out completely. It will not carry out the controlled telegram sent by the time function during disabled time until enable the time function and restart the time counting function (there is differet with the time function in the chapter 6.2). Enable is a default setting after bus voltage recovery.</p>																							
225	Output X	Scene, X	1byte	C,W	18.001 DPT_SceneControl																		
<p>It is able to recall or save the scene when sending an 8-bit command by this object, which will be enabled when enabling the scene function. The definition of the 8-bit command will be described below:</p> <p>Assuming an 8-bit command (binary coding) as: FXNNNNNN</p> <p style="padding-left: 40px;">F: recall the scene with “0”; save the scene with “1”;</p> <p style="padding-left: 40px;">X: 0</p> <p style="padding-left: 40px;">NNNNNN: scene number (0-63).</p> <p>1-64 in the parameter setup corresponds to the scene number 0-63 received by the communication object “Scene”. For example, scene 1 in the parameter setup has the same output result as scene 0 in the communication object “Scene”. As follow:</p>																							
		<table border="1" style="margin-left: auto; margin-right: auto;"> <thead> <tr> <th>Object value</th> <th>Description</th> </tr> </thead> <tbody> <tr> <td>0</td> <td>Recall scene 1</td> </tr> <tr> <td>1</td> <td>Recall scene 2</td> </tr> <tr> <td>2</td> <td>Recall scene 3</td> </tr> <tr> <td>...</td> <td>...</td> </tr> <tr> <td>63</td> <td>Recall scene 64</td> </tr> <tr> <td>128</td> <td>Store scene 1</td> </tr> <tr> <td>129</td> <td>Store scene 2</td> </tr> <tr> <td>130</td> <td>Store scene 3</td> </tr> </tbody> </table>				Object value	Description	0	Recall scene 1	1	Recall scene 2	2	Recall scene 3	63	Recall scene 64	128	Store scene 1	129	Store scene 2	130	Store scene 3
Object value	Description																						
0	Recall scene 1																						
1	Recall scene 2																						
2	Recall scene 3																						
...	...																						
63	Recall scene 64																						
128	Store scene 1																						
129	Store scene 2																						
130	Store scene 3																						

			
		191	Store scene 64		
226	Output X	Forced output, X	1bit/2bit	C,W	1.003 DPT_Enable /2.001 DPT_Switch
<p>This object will be enabled after enabling the forced function.</p> <p>If 1bit, Enable the forced operation with “1”, and the other behaviors will be ignored except the forced function; cancel the forced operation with “0”. The contact position of force operation can be set via a parameter.</p> <p>If 2bit, the contact is forced closed when receiving telegram “3”; the contact is forced opened when receiving telegram “2”; cancel the force operation with telegram “1” or “0”.</p>					
227	Output X	Switch with delay	1bit	C,W	1.001 DPT_Switch
<p>It is used to switch on the time delay by this object, which will be enabled when selecting “delay switch” in the parameter “The mode of time function”.</p>					
227	Output X	Switch with flashing	1bit	C,W	1.001 DPT_Switch
<p>It is used to switch on the flash output by this object, which will be enabled when selecting “flashing switch” in the parameter “The mode of time function”.</p>					
227	Output X	Switch with staircase lighting	1bit	C,W	1.001 DPT_Switch
<p>It is used to switch on the staircase lighting by this object, which will be enabled when selecting “staircase lighting” in the parameter “The mode of time function”.</p>					

Table 6.9 Communication object table “O, P, Q as relay control”

6.5 Communication objects of HVAC system (R~U)

6.5.1 Communication objects of “HVAC General”

6.5.1.1 Communication objects “1 Control value/2-pipe”

The heating/cooling shares the heating valve. The cooling valve can be used independently.

Number	Name	Object Function	Descr...	Group Ad...	Length	C	R	W	T	U	Data Type	Priority
240	HVAC-General	HVAC-General HEAT/COOL			1 Byte	C	-	W	-	-	8 bit unsigned value DPT_Scaling	Low
241	HVAC-General	HVAC-General COOL			1 Byte	C	-	W	-	-	8 bit unsigned value DPT_Scaling	Low

Fig. 6.10 communication objects “1 control value/2-pipe”

No.	Function	Object name	Data type	Flags	DPT
-----	----------	-------------	-----------	-------	-----

240	HVAC-General	HVAC-General HEAT/COOL	1byte	C,W	5.001 DPT_Scaling
<p>The communication object is used to receive a control signal from a thermostat on the bus. The control value can adjust the valve position.</p> <p>Telegram value 0% —OFF, no heating or cooling</p> <p>.....</p> <p>100% — ON, largest control value, maximum heating or cooling</p>					
241	HVAC-General	HVAC-General COOL	1byte	C,W	5.001 DPT_Scaling
<p>The communication object is used to receive a cooling control signal from a thermostat on the bus. It is independent of last object. The cooling valve can be additionally controlled without monitoring via the object.</p> <p>Telegram value 0% —OFF, no cooling</p> <p>.....</p> <p>100% — ON, largest control value, maximum cooling</p>					

Table 6.10 communication objects table “1 control value/2-pipe”

6.5.1.2 Communication objects “1 Control value/4-pipe with switch obj.”

The heating is realized via the heating valve, the cooling is realized via the cooling valve. But Here only heating or cooling are active. And toggle between the heating valve and the cooling valve is implemented via a separate communication object.

Number	Name	Object Function	Description	Group Ad...	Length	C	R	W	T	U	Data Type	Priority
240	HVAC-General	HVAC-General HEAT/COOL			1 Byte	C	-	W	-	-	8 bit unsigned value DPT_Scaling	Low
242	HVAC-General	HVAC-General Toggle HEAT/COOL			1 bit	C	-	W	-	-	1 bit DPT_Bool	Low

Fig. 6.11 communication objects “1 control value/4-pipe with switch obj.”

No.	Function	Object name	Data type	Flags	DPT
240	HVAC-General	HVAC-General HEAT/COOL	1byte	C,W	5.001 DPT_Scaling
<p>The communication object is used to receive a control signal from a thermostat on the bus. The control value can adjust the valve position.</p> <p>Telegram value 0% —OFF, no heating or cooling</p> <p>.....</p> <p>100% — ON, largest control value, maximum heating or cooling</p>					
242	HVAC-General	HVAC-General Toggle HEAT/COOL	1bit	C,W	DPT_Bool
<p>The communication object is used to toggle between the heating and the cooling.</p>					

If the value 1 is set in the parameter “Object value for ‘Toggle HEAT/COOL obj.’”

Telegram value 0 —— the cooling active

 1 —— the heating active

If the value 0 is set in the parameter “Object value for ‘Toggle HEAT/COOL obj.’”

Telegram value 0 —— the heating active

 1 —— the cooling active

If the object receives a toggle value, the monitor time is re-started.

Table 6.11 communication objects table “1 control value/4-pipe with switch obj.”

6.5.1.3 Communication objects “2 Control value/2-pipe”

The heating/cooling shares the heating valve. The cooling valve is unused. Here only heating or cooling are active, dependent on the last active received control value.

Number	Name	Object Function	Description	Group Ad...	Length	C	R	W	T	U	Data Type	Priority
240	HVAC-General	HVAC-General HEAT			1 Byte	C	-	W	-	-	8 bit unsigned value DPT_Scaling	Low
241	HVAC-General	HVAC-General COOL			1 Byte	C	-	W	-	-	8 bit unsigned value DPT_Scaling	Low

Fig. 6.12 communication objects “2 control value/2-pipe”

No.	Function	Object name	Data type	Flags	DPT
240	HVAC-General	HVAC-General HEAT	1byte	C,W	5.001 DPT_Scaling
<p>The communication object is used to receive a heating control signal from a thermostat on the bus.</p> <p>Telegram value 0% ——OFF, no heating</p> <p> </p> <p> 100% —— ON, largest control value, maximum heating</p>					
241	HVAC-General	HVAC-General COOL	1byte	C,W	5.001 DPT_Scaling
<p>The communication object is used to receive a cooling control signal from a thermostat on the bus.</p> <p>Telegram value 0% ——OFF, no cooling</p> <p> </p> <p> 100% —— ON, largest control value, maximum cooling</p>					

Table 6.12 communication objects table “2 control value/2-pipe”

6.5.1.4 Communication objects “2 Control value/2-pipe with switch obj.”

The heating/cooling shares the heating valve. The cooling valve is unused. And toggle between the heating and the cooling is implemented via a separate communication object.

Number	Name	Object Function	Description	Group Ad...	Length	C	R	W	T	U	Data Type	Priority
240	HVAC-General	HVAC-General HEAT			1 Byte	C	-	W	-	-	8 bit unsigned value DPT_Scaling	Low
241	HVAC-General	HVAC-General COOL			1 Byte	C	-	W	-	-	8 bit unsigned value DPT_Scaling	Low
242	HVAC-General	HVAC-General Toggle HEAT/COOL			1 bit	C	-	W	-	-	1 bit DPT_Bool	Low

Fig. 6.13 communication objects “2 control value/2-pipe with switch obj.”

No.	Function	Object name	Data type	Flags	DPT
240	HVAC-General	HVAC-General HEAT	1byte	C,W	5.001 DPT_Scaling
<p>The communication object is used to receive a heating control signal from a thermostat on the bus.</p> <p>Telegram value 0% — OFF, no heating</p> <p>.....</p> <p>100% — ON, largest control value, maximum heating</p>					
241	HVAC-General	HVAC-General COOL	1byte	C,W	5.001 DPT_Scaling
<p>The communication object is used to receive a cooling control signal from a thermostat on the bus.</p> <p>Telegram value 0% — OFF, no cooling</p> <p>.....</p> <p>100% — ON, largest control value, maximum cooling</p>					
242	HVAC-General	HVAC-General Toggle HEAT/COOL	1bit	C,W	DPT_Bool
<p>The communication object is used to toggle between the heating and the cooling.</p> <p>If the value 1 is set in the parameter “Object value for ‘Toggle HEAT/COOL obj.’”</p> <p>Telegram value 0 — the cooling active</p> <p> 1 — the heating active</p> <p>If the value 0 is set in the parameter “Object value for ‘Toggle HEAT/COOL obj.’”</p> <p>Telegram value 0 — the heating active</p> <p> 1 — the cooling active</p> <p>If the object receives a toggle value, the monitor time is re-started.</p>					

Table 6.13 communication objects table “2 control value/2-pipe with switch obj.”

6.5.1.5 Communication objects “2 Control value/4-pipe”

The heating is realized via the heating valve, the cooling is realized via the cooling valve. But Here only heating or cooling are active, dependent on the last active received control value.

Number	Name	Object Function	Description	Group Ad...	Length	C	R	W	T	U	Data Type	Priority
240	HVAC-General	HVAC-General HEAT			1 Byte	C	-	W	-	-	8 bit unsigned value DPT_Scaling	Low
241	HVAC-General	HVAC-General COOL			1 Byte	C	-	W	-	-	8 bit unsigned value DPT_Scaling	Low

Fig. 6.14 communication objects “2 control value/4-pipe”

No.	Function	Object name	Data type	Flags	DPT
-----	----------	-------------	-----------	-------	-----

240	HVAC-General	HVAC-General HEAT	1byte	C,W	5.001 DPT_Scaling
<p>The communication object is used to receive a cooling control signal from a thermostat on the bus.</p> <p>Telegram value 0% —OFF, no heating</p> <p>.....</p> <p>100% — ON, largest control value, maximum heating</p>					
241	HVAC-General	HVAC-General COOL	1byte	C,W	5.001 DPT_Scaling
<p>The communication object is used to receive a cooling control signal from a thermostat on the bus.</p> <p>Telegram value 0% —OFF, no cooling</p> <p>.....</p> <p>100% — ON, largest control value, maximum cooling</p>					

Table 6.14 communication objects table “2 control value/4-pipe”

6.5.1.6 Communication objects “Fault Control Value”

Number	Name	Object Function	Description	Group Addresses	Length	C	R	W	T	U	Data Type	Priority
243	HVAC-General	Fault Control Value			1 bit	C	R	-	T	-		Low

Fig. 6.15 communication objects “Fault control value”

No.	Function	Object name	Data type	Flags	DPT
243	HVAC-General	Fault Control Value	1bit	C,R,T	1.005 DPT_Alarm
<p>In the monitoring time, if the communication objects“HVAC-General HEAT/COOL”,“HVAC-General HEAT”or“HVAC-General COOL”do not receive the control signal from other bus device (e.g thermostat), then the communication object will send a fault report to indicate a malfunction of the thermostat, and the valve is adjusted to a safety position.</p> <p>Telegram value 0 —no fault</p> <p> 1 — fault</p> <p>The fault monitoring time starts when the parameter download has been completed. In monitoring time, if a control value is received via the objects“HVAC-General HEAT/COOL”,“HVAC-General HEAT”or“HVAC-General COOL”, the time is reset, and the monitor time is also reset when toggle between the heating and cooling.</p>					

Table 6.15 communication objects table “Fault control value”

6.5.2 Communication objects of “OUTPUT R, S---HEATING”

The following communication objects act on the heating valve.

Number	Name	Object Function	Description	Group Addresses	Length	C	R	W	T	U	Data Type	Priority
244	Valve HEAT	HEAT Disabled			1 bit	C	-	W	-	-	1 bit DPT_Enable	Low
245	Valve HEAT	HEAT Forced operation			1 bit	C	-	W	-	-	1 bit DPT_Enable	Low
246	Valve HEAT	HEAT Trigger valve purge			1 bit	C	-	W	-	-		Low
247	Valve HEAT	HEAT Status valve purge			1 bit	C	R	-	T	-	1 bit DPT_Enable	Low
248	Valve HEAT	HEAT Valve position status			1 Byte	C	R	-	T	-	8 bit unsigned value DPT_Scaling	Low

Fig 6.16 communication objects of “OUTPUT R, S--HEATING”

No.	Function	Object name	Data type	Flags	DPT
244	Valve HEAT	HEAT Disabled	1bit	C,W	1.003 DPT_Enable
<p>Via the communication object, the heating valve can be disabled or enabled. The valve position is set to 0% when disabled; the valve reverts back to its previous position when enabled again. Please refer to the description in the end of the section 5.6.3.</p> <p>If the parameter “Disable Heat on object value” is set to “1”:</p> <p>Telegram value 0 ——the valve not disabled 1 —— the valve disabled</p> <p>If the parameter “Disable Heat on object value” is set to “0”:</p> <p>Telegram value 0 ——the valve disabled 1 ——the valve not disabled</p>					
245	Valve HEAT	HEAT Forced operation	1bit	C,W	1.003 DPT_Enable
<p>The communication object is used to enable the forced operation.</p> <p>If the parameter “Forced operation on object value” is set to “1”:</p> <p>Telegram value 0 ——end forced operation 1 —— start forced operation</p> <p>If the parameter “Forced operation on object value” is set to “0”:</p> <p>Telegram value 0 ——start forced operation 1 ——end forced operation</p>					
246	Valve HEAT	HEAT Trigger valve purge	1bit	C,W	1.017 DPT_Trigger
<p>The communication is used to trigger the valve purge. When the valve purge is triggered, the valve will be fully opened.</p> <p>Telegram value 0 ——end valve purge 1 ——start valve purge</p>					
247	Valve HEAT	HEAT Status valve purge	1bit	C,R,T	1.003 DPT_Enable
<p>The status of the valve purge is indicated via this communication object as soon as a purge has been activated. The status remains active even when the purge has been interrupted, e.g. by a priority.</p> <p>Telegram value 0 ——valve purge not active 1 ——valve purge active</p>					

248	Valve HEAT	HEAT Valve position status	1byte	C,R,T	5.001 DPT_Scaling
<p>The communication object is enabled if in parameter window “function” the parameter “Enable ‘Valve position status’ object”, the option “1byte” has been selected.</p> <p>The status of the valve position is indicated via this communication object.</p> <p>The target position, to where the valve should move, is always transferred.</p> <p>Telegram value 0 ...100%</p>					
248	Valve HEAT	HEAT Valve position status	1bit	C,R,T	1.001 DPT_Switch
<p>The communication object is enabled if in parameter window “function” the parameter “Enable ‘Valve position status’ object”, the option “1bit” has been selected.</p> <p>The status of the valve position is indicated via this communication object.</p> <p>The target position, to where the valve should move, is always transferred.</p> <p>Please refer to the description of the parameter “Object value with valve position >0” in the section 5.6.2.1.</p>					

Table 6.16 communication objects table “OUTPUT R, S--HEATING”

6.5.3 Communication objects of “OUTPUT T, U---COOLING”

The communication objects that act on the cooling valve are the same with the heating valve. Please refer to description of the objects in the chapter 6.5.2.

6.6 Communication objects of Dimming outputs (V, W)

6.6.1 Communication objects “General dimming”

Number	Name	Object Function	Description	Group Addresses	Length	C	R	W	T	U	Data Type	Priority
100	DIM V	Switch			1 bit	C	-	W	-	-		Low
101	DIM V	Switch status			1 bit	C	R	-	T	-		Low
102	DIM V	Relative dimming			4 bit	C	-	W	-	-		Low
103	DIM V	Brightness			1 Byte	C	-	W	-	-		Low
104	DIM V	Brightness status			1 Byte	C	R	-	T	-		Low
105	DIM V	Scene / save V			1 Byte	C	-	W	-	-		Low

Fig. 6.17 Communication objects “general dimming”

No.	Function	Object name	Data type	Flags	DPT																																				
100	DIM X	Switch	1bit	C,W	1.001 DPT_Switch																																				
<p>This object is used to receive the switch command to switch the dimmer actuator. It will switch on the dimmer actuator with “1”, off with “0”.</p>																																									
101	DIM X	Switch status	1bit	C,R,T	1.001 DPT_Switch																																				
<p>This object is used to report the status of the current switch to the bus. The object will send “1” to the bus when the value of the brightness is larger than 0, mean the switch is on; “0” to the bus if value of “0”, mean the switch is off. The object will be enabled when selecting “It is new status” in the parameter “Status report”.</p>																																									
102	DIM X	Relative dimming	4bit	C,W	3.007 DPT_Control Dimming																																				
<p>This object is used to dim up or down the outputs. It will dim down when the telegram value is from 1 to 7. During this range, smaller amplitude of dimming down with larger value; that means it will dim down to the biggest amplitude with 1, while to the smallest amplitude with 7, and 0 means stop dimming. It will dim up when the telegram value is from 9-15. During this range, smaller amplitude of dimming up with larger value; that means it will dim up to the biggest amplitude with 9, while to the smallest amplitude with 15, and 8 means stop dimming. Defined as follow:</p>																																									
<table border="1"> <tbody> <tr> <td>Object value</td> <td>0</td> <td>1</td> <td>2</td> <td>3</td> <td>4</td> <td>5</td> <td>6</td> <td>7</td> </tr> <tr> <td>Dim down</td> <td>Unchanged/ stop dimming</td> <td>255</td> <td>128</td> <td>64</td> <td>32</td> <td>16</td> <td>8</td> <td>4</td> </tr> <tr> <td>Object value</td> <td>8</td> <td>9</td> <td>10</td> <td>11</td> <td>12</td> <td>13</td> <td>14</td> <td>15</td> </tr> <tr> <td>Dim up</td> <td>Unchanged/ stop dimming</td> <td>255</td> <td>128</td> <td>64</td> <td>32</td> <td>16</td> <td>8</td> <td>4</td> </tr> </tbody> </table>						Object value	0	1	2	3	4	5	6	7	Dim down	Unchanged/ stop dimming	255	128	64	32	16	8	4	Object value	8	9	10	11	12	13	14	15	Dim up	Unchanged/ stop dimming	255	128	64	32	16	8	4
Object value	0	1	2	3	4	5	6	7																																	
Dim down	Unchanged/ stop dimming	255	128	64	32	16	8	4																																	
Object value	8	9	10	11	12	13	14	15																																	
Dim up	Unchanged/ stop dimming	255	128	64	32	16	8	4																																	
103	DIM X	Brightness	1byte	C,W	5.001 DPT_Scaling																																				
<p>It is used to receive a brightness value to switch the dimmer actuator, switching on the actuator when the received value is larger than 0, off or stay to the lower threshold value with “0”, which is defined by the parameter setup in the brightness</p>																																									

value dimming.																											
104	DIM X	Brightness status	1byte	C,R,T	5.001 DPT_Scaling																						
<p>This object is used to send the brightness status of the current output to the bus whatever causes the changes of the value. The object will be enabled when selecting “Transmit new brightness” in the parameter “Brightness value OBJ transmit after dimming”.</p>																											
105	DIM X	Scene/save	1byte	C,W	18.001 DPT_SceneControl																						
<p>It is able to recall or save the scene when sending an 8-bit command by this object, which will be enabled when enabling the scene function. The definition of the 8-bit command will be described below:</p> <p>Assuming an 8-bit command (binary coding) as: FXNNNNNN</p> <p style="padding-left: 40px;">F: recall the scene with “0”; save the scene with “1”;</p> <p style="padding-left: 40px;">X: 0</p> <p style="padding-left: 40px;">NNNNNN: scene number (0-63).</p> <p>1-64 in the parameter setup corresponds to the scene number 0-63 received by the communication object “Scene/save”. For example, scene 1 in the parameter setup has the same output result as scene 0 in the communication object “Scene/save”. As follow:</p>																											
<table border="1"> <thead> <tr> <th>Object value</th> <th>Description</th> </tr> </thead> <tbody> <tr><td>0</td><td>Recall scene 1</td></tr> <tr><td>1</td><td>Recall scene 2</td></tr> <tr><td>2</td><td>Recall scene 3</td></tr> <tr><td>...</td><td>...</td></tr> <tr><td>63</td><td>Recall scene 64</td></tr> <tr><td>128</td><td>Store scene 1</td></tr> <tr><td>129</td><td>Store scene 2</td></tr> <tr><td>130</td><td>Store scene 3</td></tr> <tr><td>...</td><td>...</td></tr> <tr><td>191</td><td>Store scene 64</td></tr> </tbody> </table>						Object value	Description	0	Recall scene 1	1	Recall scene 2	2	Recall scene 3	63	Recall scene 64	128	Store scene 1	129	Store scene 2	130	Store scene 3	191	Store scene 64
Object value	Description																										
0	Recall scene 1																										
1	Recall scene 2																										
2	Recall scene 3																										
...	...																										
63	Recall scene 64																										
128	Store scene 1																										
129	Store scene 2																										
130	Store scene 3																										
...	...																										
191	Store scene 64																										

Table 6.17 Communication objects table “general dimming”

6.6.2 Communication objects “staircase lighting”

Number	Name	Object Function	Description	Group Addresses	Length	C	R	W	T	U	Data Type	Priority
100	DIM V	Switch			1 bit	C	-	W	-	-		Low
103	DIM V	Permanent on			1 Byte	C	-	W	-	-		Low

Fig.6.18 Communication objects “staircase lighting”

GVS K-BUS® KNX/EIB Room Controller

No.	Function	Object name	Data type	Flags	DPT
100	DIM X	Switch	1bit	C,W	1.001 DPT_Switch
<p>The communication object is used to switch on the staircase light function of dimmer with telegram “1”. It will switch off the staircase lighting after a certain on time, and the ON duration time are defined by “Duration of staircase lighting: Base” and “Duration of staircase lighting: Factor” and lights on duration is: duration=base*factor. It will be off automatically after the time. It can also switch off the lights with telegram “0”.</p>					
103	DIM X	Permanent on	1bit	C,W	1.001 DPT_Switch
<p>The object receives the value “1” to switch on staircase light for a long time, receives the value “0” to switch off the staircase light.</p>					

Table 6.18 Communication objects table “staircase lighting”

7. Manual function description

Room Controller provides manual function for All of outputs. If it is electronic manual operation, only bus power recovers can it be operated; If it is mechanic manual operation, it can be operated in any case. when bus power recovers, electronic manual function is defined in first function group .Electronic manual function is show as following:

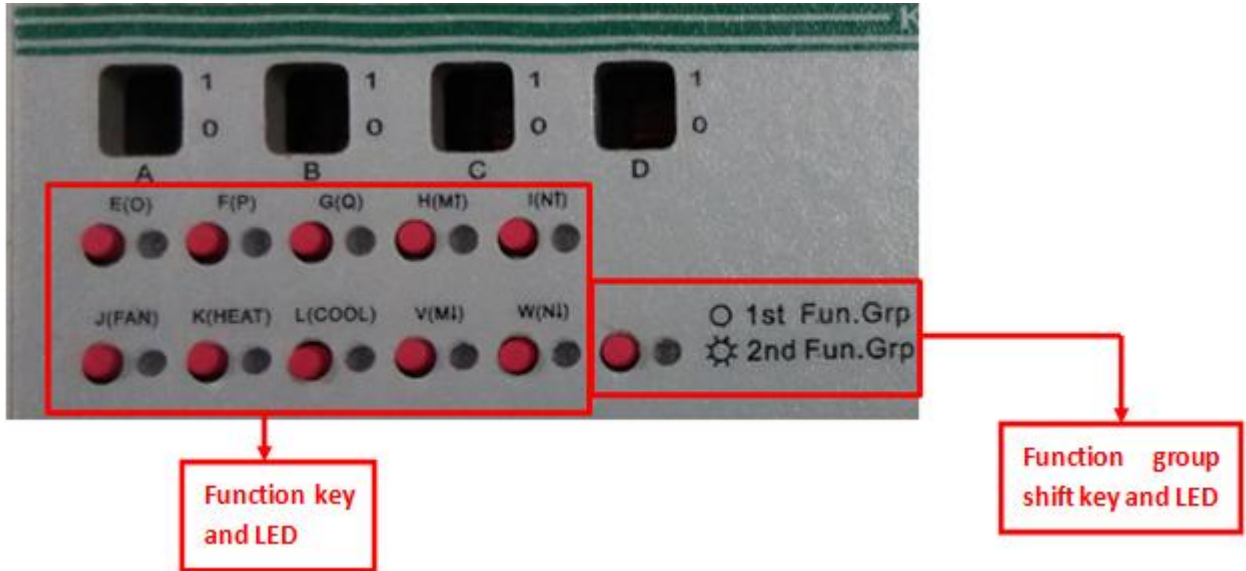

Fig 7.1 manual function

As show in Fig 7.1, there are two kinds of manual function button according to their use:

1. **Function key**:control the certain output
2. **Function group shift key**:shift function group, that is said that it can shift the function of manual key and LED

If the LED in the right of function group shift key is off, function key can control the outputs of channel E、F、G、H、I、J、K、L、V、W;

If the LED in the right of function group shift key is on, function key can control the outputs of channel O、P、Q、M、N、R、S、T、U。

The LED of function group can be cyclically indicated between on and off via operating function group shift key.

Therefore, make sure that operating function group key to make LED be on, then the outputs of shutter、fan speed and HVAC function can be controlled via function key.

Manual operation for every function are described as following:

Switch outputs:the processing of Fig 5. 10 do not disturb manual function output, the correspond of switch output is excuted immediately. However, the priority of manual function is lower than that of Force operation

Shutter outputs: it can be achieved through operating key “H(M↑)”, “I(N↑)”, “V(M↓)” and “W(N↓)”. short operation is the same as the function of communication object “Louvre adj./Stop”, long operation is the same as the function of communication object “Shutter UP/DOWN”. when shutter is running, LED will flash; If both of blinds and louvre arrive at minimum or maximum position, LED will be on

Fan control: manual operation of fan is achieved by button “J(FAN)”. short operation can adjust fan speed, long operation can cut off fan; but the indicate LED of fan speed is O、P、Q.

O-lower speed, P-middle speed, Q-high speed

Valve control: short operation of button “K(HEAT)” can control HEATING(R, S), short operation of “L(COOL)” can control COOLING(T, U), while long operation of one of these two buttons can cancel manual function of valve. short operation is the function of all-on or all-off.

Dimming outputs: short operation is the same as the function of communication object “switch”, long operation is the same as the function of communication object “Relative dimming”, and the dimming mode is “start-stop dimming”. when dimming is running, LED will flash; when dimming is complete, the status of LED will be depended on the status of channel output